



**PURE CHLORINE & —**  
**— EASY OPERATION**

**SSCnano**  
**Salt Chlorinator**  
For Above and Inground Pool



# COMPACT AND SIMPLE INSTALLATION

Emaux SSCnano is simple to install, with basic plumbing and electrical connections, you can have the system up and running in no time. It is compact and easily fits for pool and spa. Compact design makes it can easily fit into tight spaces without compromising its functionality. The control is designed to be user-friendly, making it easy to set up and operate, allows you to adjust the chlorine production according to your specific needs. You can tailor the chlorine output to maintain the desired sanitization level for your pool or spa.



CE IPX4

## Product feature:

- ON/OFF operation
- Water flow switch
- Auto self cleaning reverse polarity
- Temperature sensor
- Long cell life

Salt level alert

Adjustable chlorine production time

Preset timer



# Installation Diagram

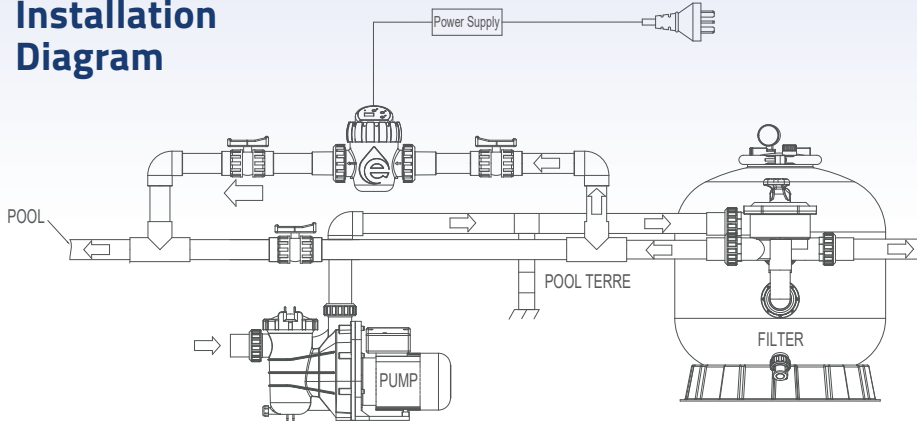

Material  
PMMA / ABS

Operation Voltage  
110V - 240V

Max. pool volume  
20 m<sup>3</sup> - 50 m<sup>3</sup>

Salt Level  
3500 ppm

Working Temperature  
10 - 45 °C

Waterproof Standard  
IPX4

### 3 installation methods:

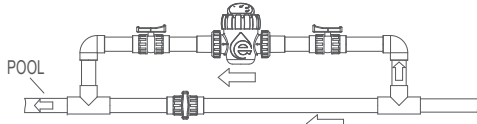

Horizontal Installation

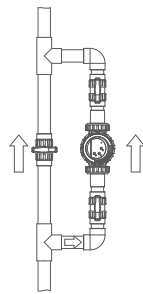

Vertical Installation

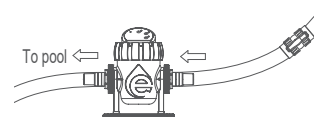

Flexi hose connector Installation

## Accessories & Power Supply:

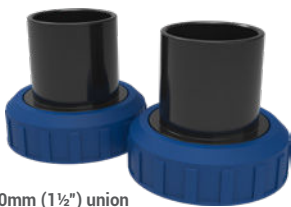

50mm (1 1/2") union

32mm (1 1/4") &  
38mm (1 1/2")  
Flexi hose connector



Mounting stand



Switch mode  
power supply

## Product Information

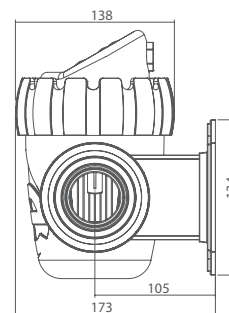
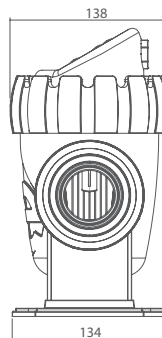
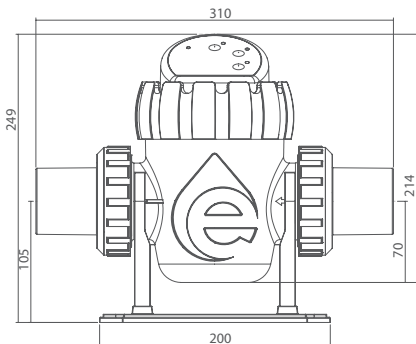

Code	Model	Input Voltage/ Frequency	Salt Level	Cell production rate	Maximum working pressure	Cell Connections	Working Temperature	Min. Flow	Max. Pool Volume
9130045	SSCnano4			4 g/hr		1.5" / 50mm			20 m <sup>3</sup>
9130046	SSCnano6	110 - 240 V	3500	6 g/hr	2.5 bar	and 32mm	10-45 °C	3 m <sup>3</sup> /hr	30 m <sup>3</sup>
9130047	SSCnano8	/ 50-60 Hz	ppm	8 g/hr		& 38mm			40 m <sup>3</sup>
9130048	SSCnano10			10 g/hr		union			50 m <sup>3</sup>



**EMAUX WATER TECHNOLOGY CO., LTD**

ADDRESS: Flat A-D, 20/F., Kai Bo 22, 22 Wing Kin Road,  
Kwai Chung, HK

PHONE +852 2832 9880

[www.emauxgroup.com](http://www.emauxgroup.com)

 **YOUR PREMIER SUPPLIER**