



HOLL S Utopia Steam Sauna Installation Guide

[Home](#) » [HOLL S](#) 

Contents

- [1 Utopia Steam Sauna](#)
- [2 Product Information](#)
- [3 Product Usage Instructions](#)
- [4 RECOMMENDATIONS](#)
- [5 SAFETY INSTRUCTIONS](#)
- [6 General features](#)
- [7 Certificates](#)
- [8 INSTALLATION](#)
 - [8.1 Choice of location](#)
- [9 INFORMATION](#)
 - [9.1 Ignition and delayed start:](#)
- [10 RECTANGULAR MODEL](#)
- [11 ASSEMBLY](#)
- [12 CONTROL PANEL](#)
- [13 MAINTENANCE](#)
- [14 SERVICING & WARRANTY](#)
- [15 Documents / Resources](#)
 - [15.1 References](#)



Utopia Steam Sauna



Product Information

The product is a sauna cabin called “Utopia”. It comes with a control panel, right panel, bench, bench support, floor grating, front panel, left panel, roof panel, backrest, speakers, and a bucket with a ladle. The electrical requirements for the sauna cabin are listed in the manual, and it is important to adhere to them for safety reasons. The manual also includes instructions for installation, assembly, and maintenance of the sauna cabin.

Product Usage Instructions

Before using the sauna cabin for the first time, it is important to read the manual carefully and keep it in a safe place for future reference. The manual includes safety instructions that must be adhered to strictly to prevent hyperthermia, heat stroke, or heat exhaustion. The sauna must not be used by certain individuals.

To use the sauna cabin:

1. Choose an appropriate location for the sauna cabin.
2. Follow the instructions in the manual for installation and assembly of the cabin.
3. Make sure to adhere to the electrical requirements listed in the manual.
4. When using the sauna cabin, make sure to follow the safety instructions carefully.
5. After use, follow the maintenance instructions listed in the manual to keep the sauna cabin in good condition.

RECOMMENDATIONS

- Install the sauna on a perfectly flat floor.
- The sauna must remain in a dry area.
- Do not use it near a source of water (bath, damp floor, swimming pool).
- Do not use liquid cleaning products.
- Disconnect the sauna before cleaning and use a wet rag. (see Maintenance section)
- Protect the sauna’s electrical cable to avoid it being crushed or pinched.
- Prior to replacing certain components, ensure that they are specified by the manufacturer or that they have the same features as the original parts. Incorrect replacement can cause a fire, a shortcircuit or damage to the sauna. We strongly recommend using a qualified technician.
- To avoid the risk of burns or electric shocks, do not use any metal tools.

- Do not put animals in the sauna.
- Do not leave the sauna switched on without supervision.
- Do not leave the sauna switched on for more than 3 hours at a time to avoid premature deterioration of the equipment. After 3 hours continuous usage, switch off the sauna for at least one hour.
- We recommend that you do not install a locking system on the sauna door.
- Check compliance of your electrical installation prior to connecting your sauna to the power supply.

SAFETY INSTRUCTIONS

IMPORTANT : Please read the safety instructions carefully before installing and using your sauna cabin. They are essential for your safety, so please adhere strictly to them.

Beware of hyperthermia, heat stroke or heat exhaustion which can be caused or aggravated by noncompliance with the safety instructions. Symptoms are fever, a rapid pulse, dizziness, fainting, lethargy and numbness in all or part of the body. The effects are: reduced awareness of the heat, ignorance of imminent risks, loss of consciousness.

The sauna must not be used by :

- Children under 6 years of age.
- People with severe reactions to sunlight.
- Elderly or disabled people.
- People with previous medical conditions such as heart disease, high or low blood pressure, blood circulation problems or diabetes without prior medical advice.
- Pregnant women
- Excessive temperature can endanger the foetus.
- Persons suffering from dehydration, open sores, eye disorders, burns or sunstroke.

In the event of problems involving health, medication or injury to muscles or ligaments, do not use the sauna without previously consulting a doctor and obtaining approval.

If surgical implants are worn, do not use the sauna without previously consulting a doctor and obtaining his approval.

Do not use the sauna after strenuous activity.

Wait 30 minutes for your body to cool down.

Do not spend more than 40 minutes in the sauna at any one time.

Do not consume alcohol or drugs before or during the session.

Do not sleep in the sauna when it is in operation.

To avoid the risk of overheating, connect your sauna to a sufficiently powerful electrical outlet and do not connect other electrical equipment to the same wall socket.

To avoid any risk of electrocution or damage to the sauna, do not use it:

- During thunderstorms.
- If the electrical cable is damaged, it must be replaced by a qualified person.
- If the electrical cable overheats, it must be checked by a qualified person.
- If you have to change a bulb, wait until the sauna is switched off and cooled down. Dry your hands before connecting or disconnecting the electricity.
- Never work with wet hands or feet.

Do not switch the electricity or the heating system rapidly on or off as this could damage the electrical system.

Do not try to repair the sauna by yourself without the agreement of the sauna's distributor or manufacturer.

Unauthorised attempts to repair it will invalidate the manufacturer's warranty.

Do not use any type of detergent inside the sauna.

- Do not pile up or store objects inside or on top of the sauna.

- Do not place flammable materials or chemical agents near the sauna.

General features

- Cabin made from Canadian wood
- Hourglass
- Starry sky
- Ventilation grid
- Warranty 2 years electronics, 10 years woodwork
- Steam accessories

Certificates

Complies with current European standards.

Manufacturing process uses no heavy metals.

Common

- 1 x installation & user manual
- 1 x door handle (internal and external part)
- 1 x Electric Stove Protection Cradle
- 1 x steam sauna accessory pack
- (Including thermometer, hygrometer, hourglass, bucket, ladle and light fixture)

INSTALLATION

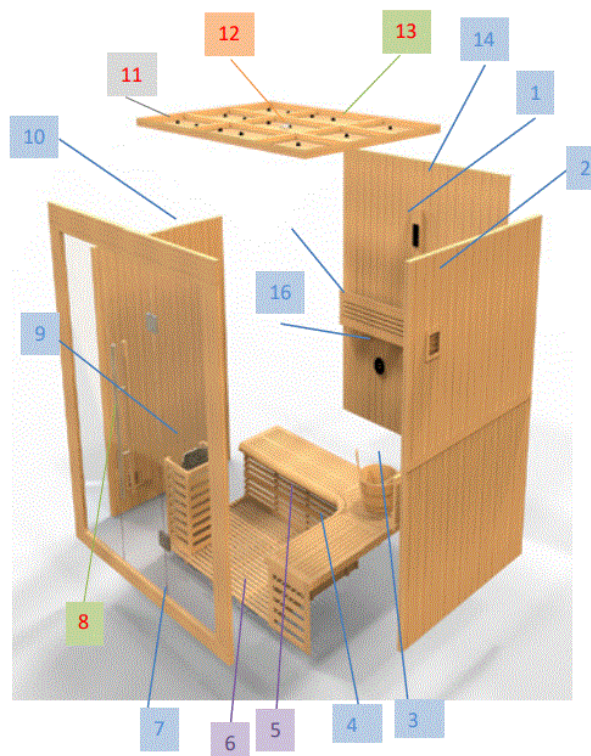

	Name
1	Media control panel
2	Right Panel
3	Wood bucket and spoon
4	Bench
5	Bench support
6	Floor panel
7	Front panel
8	Handle
9	Sauna stove
10	Left panel
11	Sky light
12	Reading light
13	Top panel
14	Back panel
15	Backrest
16	Trumpet

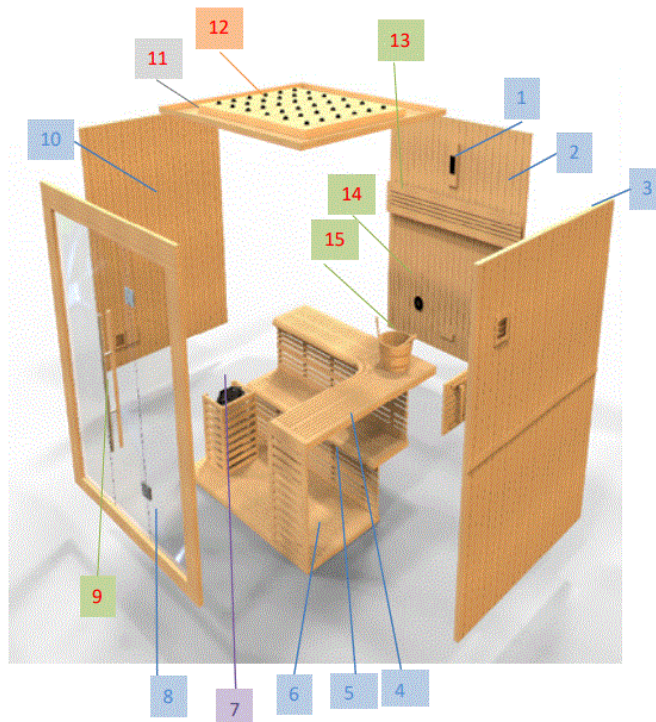

	Name
1	Media control panel
2	Back panel
3	Right panel
4	Bench
5	Bench support
6	Floor panel
7	Sauna stove
8	Front panel
9	Handle
10	Left panel
11	Top panel
12	Sky light
13	Backrest
14	Trumpet
15	Wood bucket & spoon

Read the assembly instructions carefully before starting.

Choice of location

Sauna-Center saunas are designed solely for interior installation. Select a space:

- • Inside, in a dry area, on a flat stable floor that can support the weight of your sauna.
 - The height must be sufficient for you to reach the ceiling and carry out electrical connections and maintenance.
 - Away from any source of water, flames or flammable materials.
- **Practical advice:**
 - • Note that sauna assembly requires two or three adults.
 - Clearly identify each panel before you begin.
 - During assembly, position your sauna's mains cable so that it is easily accessible.
 - Note that there are variations between the models.

Read the assembly instructions carefully before starting assembly.

Electrical connections

The electrical installation of the stove must be carried out by a professional and sized according to the power of the stove. The stove is thus connected with its own electric line, not supplied as it depends on your installation. This installation must be planned before mounting the cabin.

The entire internal electrical installation of the sauna (lights, LEDs, etc.) is connected direct-ly to the electric stove, the electric cables being pre-wired within the cabin.

Electrical sizing:

Power of the stove (kW)	Sauna volume (m3)		Electrical connection			
			230V 1N	Fuse	400V 3N	Fuse
4,5	3	6	3 x 2,5	1 x 20	5 x 1,5	3 x 10
6	5	8	3 x 2,5	1 x 35	5 x 1,5	3 x 10
8	7	12	3 x 6	1 x 35	5 x 2,5	3 x 16
9	8	14	3 x 10	1 x 50	5 x 2,5	3 x 16

Electrical connection for Har-via Vega stove

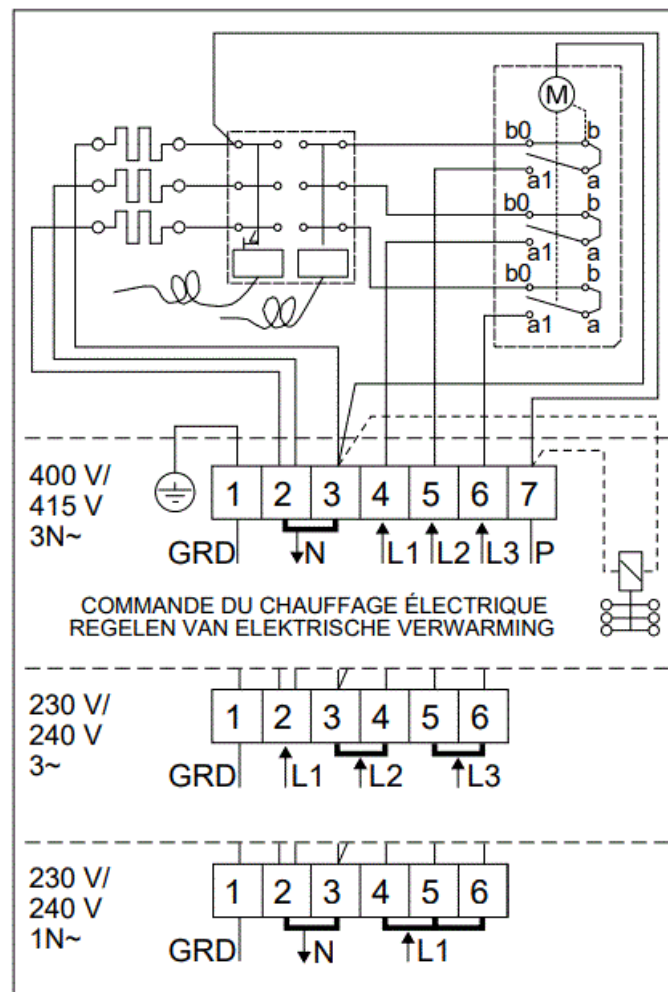

INFORMATION

Ignition and delayed start:

Zone A

operation from 1 to 4 hours

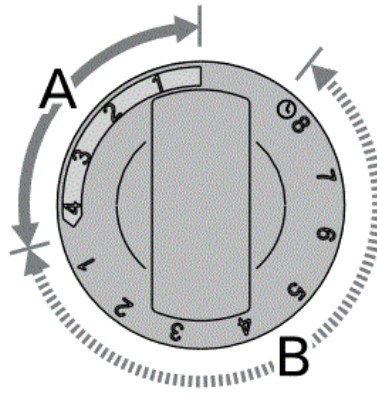

Zone B

Delayed departure from 0 to 8 a.m.

General explanations on the operation of the Harvia stove:

The temperature rise in the sauna is done in stages. A booth takes on average 30 to 45 minutes to reach a temperature of 65-70 ° C. During this period, the lava stones store heat.

To reach higher temperatures, it is necessary to add water to the stones. The steam thus generated will allow a gradual and measured increase in temperature.

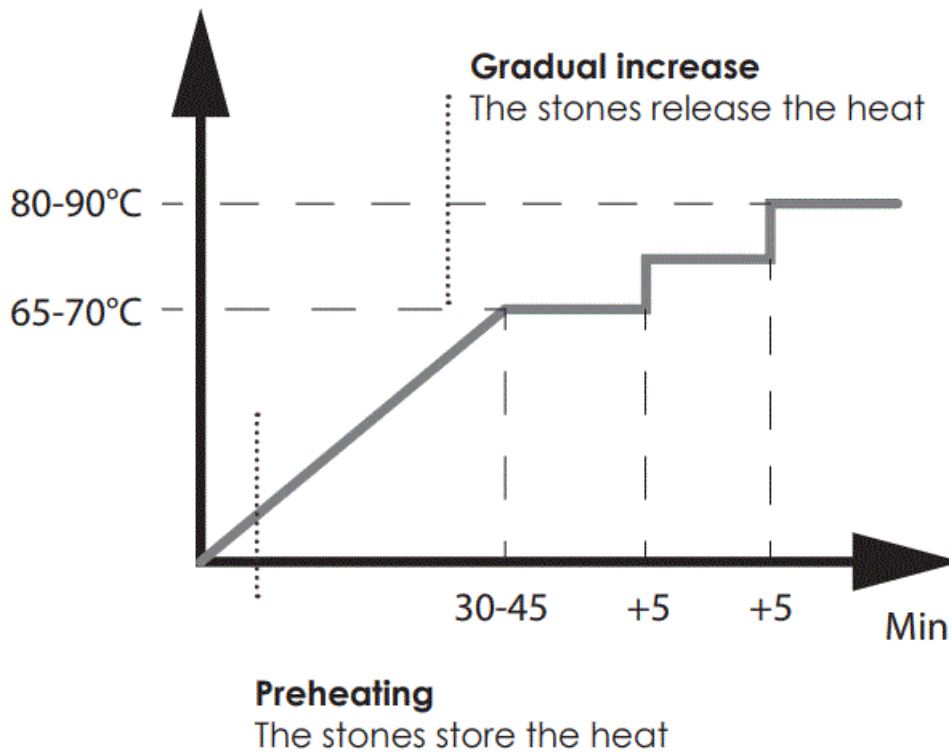

RECTANGULAR MODEL

UTOPIA 4

roof panel	5x40mm	10
front panel	5x50mm	8
rear panel	6x75mm	8
stove stand	5x40mm	12
Folders	3.5x35mm	3
Bench stand	5x50mm	4
Bench	5x50mm	2

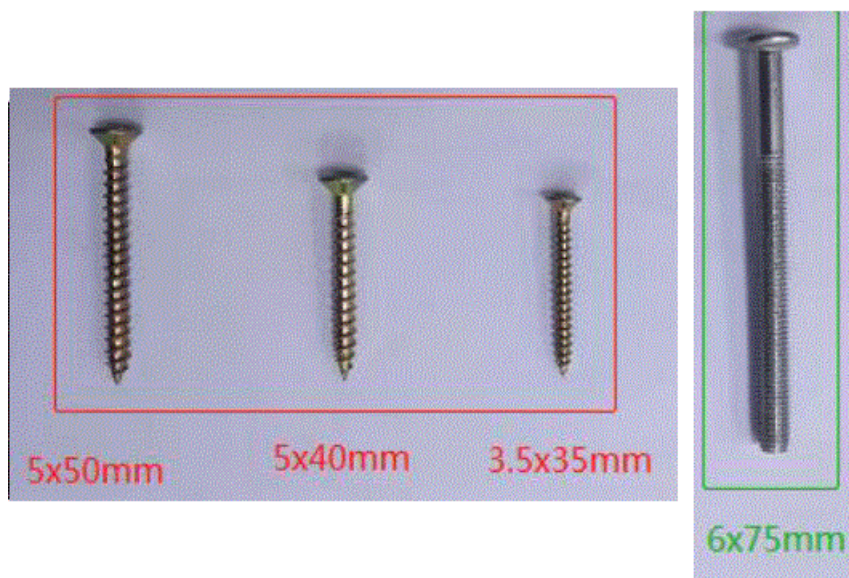

ASSEMBLY

1. Start by positioning the floor on the ground where you want to install the sauna.

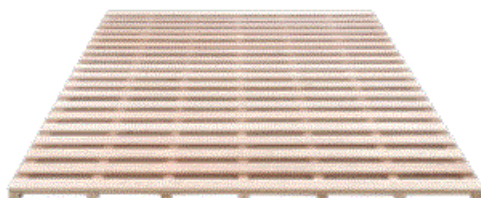

2. Install the front panel

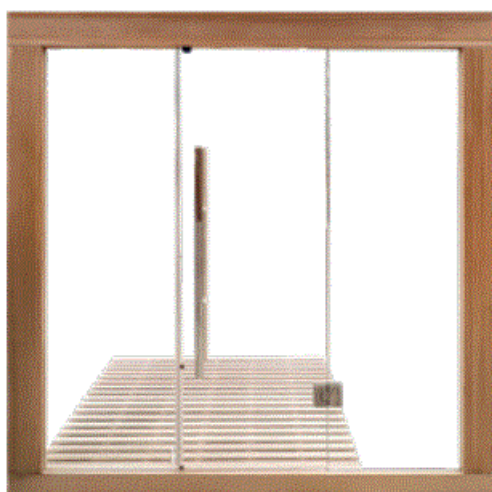

3. Position the left and right side panel using the screws provided



4. Position the rear panel using the hooks

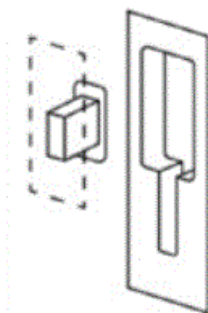

5. Mount the vertical supports of the benches, then position the benches on the cleats and support



6. You can screw the benches for more solidity. To do this, screw diagonally.

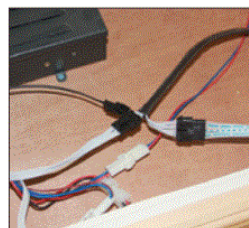
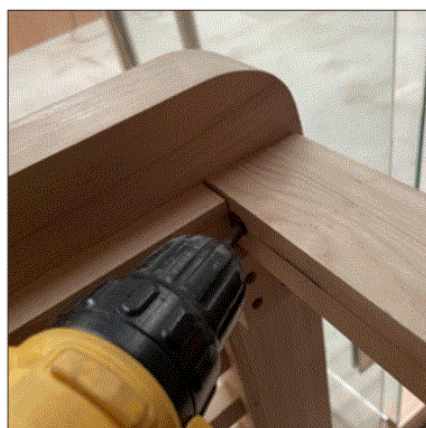

Also connect the cables between the roof and the rear panel.

7. Carefully position and fit the roof.



8. position the backrests on the horizontal cleats, then screw them.



9. Connect the connection plugs of the LED strips of the backrests to the sockets available on the rear panel.

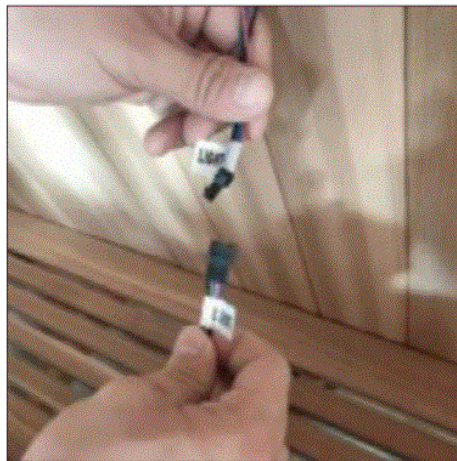

10. Please place and screw the pan support according to the position of the ventilation



11. On the outside of the door, position the handle in line with the holes provided.
Insert the screws through the inside of the door and fix the handle.

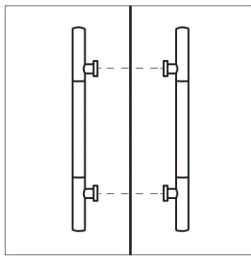

RECTANGULAR MODEL

UTOPIA 6

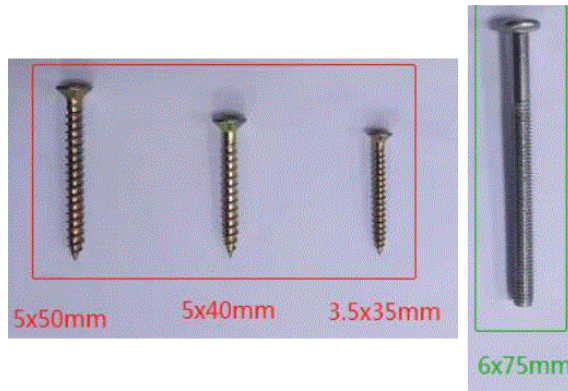

roof panel	5x40mm	12
front panel	5x50mm	8
rear panel	6x75mm	8
stove stand	5x40mm	12
Folders	3.5x35mm	6
Bench stand	5x50mm	8
Bench	5x50mm	4

1. Start by positioning the floor on the ground where you want to install the sauna.

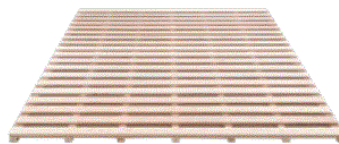

2. Position the front panel

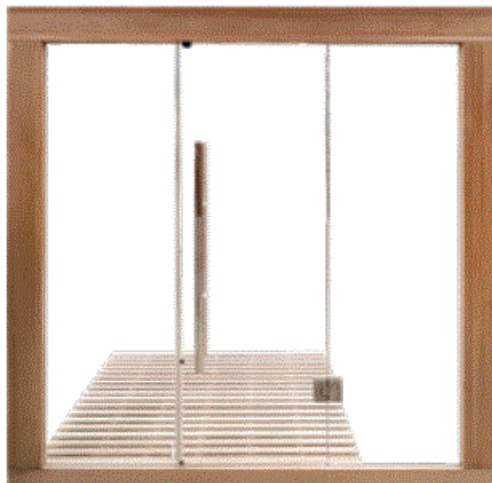

3. Position the left and right side panel using the screws provided



4. Position the rear panel using the hooks

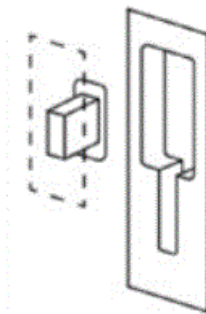

5. Position the vertical supports using the pre-installed cleats



6. Screw the specific cleat to the right bench seat



7. Position the vertical supports using the pre-installed cleats



8. Place the benches on the fixed supports



9. position the backrests on the horizontal cleats, then screw them.

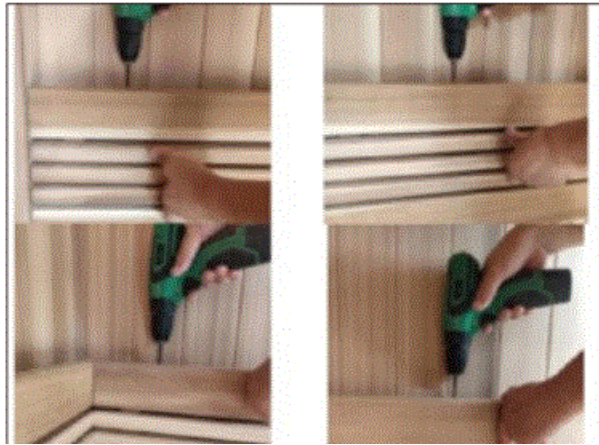

10. Connect the connection plugs of the LED strips of the backrests to the sockets available on the rear panel. Also connect the cables between the roof and the rear panel.

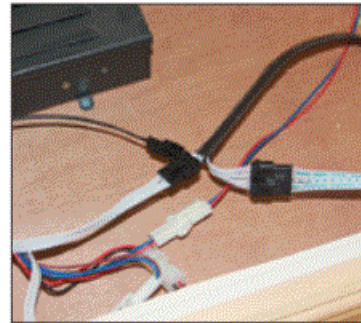
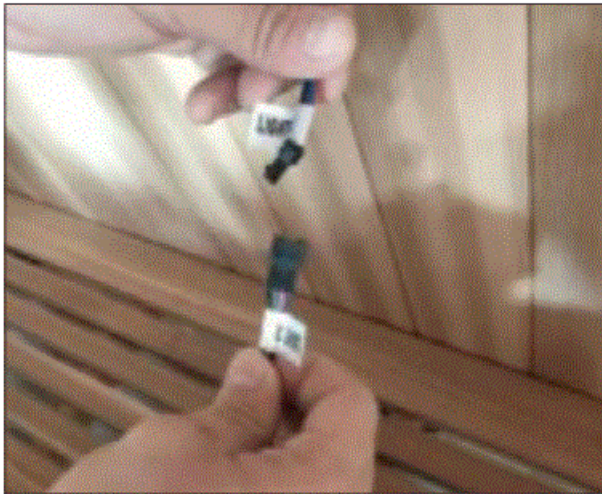

11. Please place and screw the pan support according to the position of the ventilation. Connect the stove electrically as well as the electrical elements of the cabin, then install it and add the stones on top in a homogeneous manner.

Do not drop stones into the stove.

Do not wedge the stones between the resistances.

The stones must not be too tight, they must support each other without resting on the resistances.

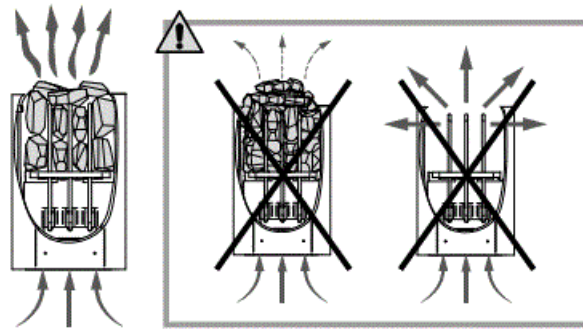

CONTROL PANEL



- Control panel
- Input voltage AC100V – AC240V

- Bluetooth
- Power consumption 50Hz, 60Hz
- Press “Power” to turn on/off the booth
 - Press «Power» to turn on the control panel, an appliance sun symbol. The guide light comes on.
 - Press «Power» again to turn off the control panel
- The light switches off automatically after 45 min.
- “Light 1” turns on the guide light “Light 2” turns on the mood LEDs
- «Media» turns on the FM radio, you can change radio frequency using the left and right arrows.
- To save a radio station, press “Set” until the “VOL” panel flashes. Select the saved number with the arrows and press «MEM» for 3s to save the station.
- Press «Media» again to turn on Bluetooth. Select the “JOYONWAY” network and use the password “2288” to pair your device.
- The Bluetooth symbol flashes when you can pair your bluetooth audio device.
- To pause the music, press “MEDIA” for 3s. To switch from one song to another, use the left and right arrows.
- To change the listening volume, press «SET» until «VOL» flashes, then use the left and right arrows.

MAINTENANCE

Disconnect the cabin’s power supply cable before undertaking any work.

Problems identified	Possible reasons	Solutions
Electric stove does not heat up.	Power supply cable disconnected	Check power supply cable connection
	The general power supply is cut	Check that the switchboard and wall plug are working
	Stove is overheat protected.	Refer to the electric stove manual

SERVICING & WARRANTY

Servicing

1. Disconnect your sauna.
2. Use a vacuum cleaner to remove dust from crevices in the woodwork.
3. Clean the cabin with a damp cotton cloth and use a small amount of soap if necessary. Rinse with a damp cloth.
4. Wipe with a dry cloth.

IMPORTANT

Do not use benzene, alcohol, chemical agents or strong detergents on the sauna since chemical products can damage the wood and its protective coating. Do not spray water on your sauna.

Practical advice:

To extend the life of your sauna, we recommend that you apply linseed oil to the benches, back rests and flooring of your cabin with a lint-free cloth.

If your sauna’s flooring or bench are indelibly marked, rub them lightly with sandpa-per.

Warranty

All the components of France-Sauna saunas are guaranteed for 2 years and wood 10 years..

The warranty comes into force on the date of dispatch (corresponding to the date the invoice is issued).

The warranty does not apply in the following cases :

- Malfunction or damage arising from installation, usage or repair that are not in compliance with the safety instructions.
- Malfunction or damage arising from conditions that are unsuitable for the equipment's originally intended purpose.
- Damage arising from negligence, accident or force majeure (thunderstorm or bad weather).
- Malfunction or damage arising from the use of non-authorized accessories.

The warranty does not cover the costs linked to returning the cabin or part of its components to our workshops of. Under the warranty, in the event of a breakdown, the items deemed defective by our technicians will be exchanged. Information and explanations required for their installation will be provided by one of our technicians. Costs linked to the use of subcontract labour provided by a third party cannot be covered by France-sauna.

Documents / Resources

	<p>HOLL S Utopia Steam Sauna [pdf] Installation Guide Utopia Steam Sauna, Utopia, Steam Sauna, Sauna</p>
---	--

References

- [HOLL'S - La maison du sauna](#)