

ENERGYLINE PRO

**POMPE A CHALEUR POUR PISCINE
SWIMMING POOL HEAT PUMP UNIT
UNIDAD DE BOMBA DE CALOR PARA PISCINAS
BOMBA DE AQUECIMENTO PARA PISCINAS
HEIZPUMPENANLAGE FÜR EIN SCHWIMMBECKEN
ZWEMBAD WARMTEPOMP
UNITÀ DI RISCALDAMENTO A POMPA DI CALORE PER PISCINE
VARMEPUMPE TIL SVØMMEBASSENG
ТЕПЛОВОЙ НАСОС ДЛЯ ПЛАВАТЕЛЬНОГО БАСЕЙНА**



ENP10TAS

**Manuel d'instructions et d'installation
Installation & Instruction Manual
Manual de Instalación e Instrucciones
Manual de instalação e de instruções
Einbau- & Anleitungshandbuch
Installatie- en bedieningshandleiding
Manuale d'Uso e di Installazione
Installerings- og brukerveiledning
Руководство по монтажу и эксплуатации**

ENERGYLINE PRO

POMPE A CHALEUR POUR PISCINE



ENP10TAS

Manuel d'instructions et d'installation

SOMMAIRE

1. CONSIGNES GÉNÉRALES - SÉCURITÉ	1
2. CARACTÉRISTIQUES TECHNIQUES	4
2.1 Données techniques de la pompe à chaleur	4
2.2 Plage de fonctionnement	5
2.3 Dimensions	6
3. INSTALLATION ET RACCORDEMENT	7
3.1 Schéma de principe	7
3.2 Pompe à chaleur	7
3.3 Raccordement hydraulique	9
3.4 Raccordement électrique	10
3.5 Premier démarrage	11
3.6 Réglage du débit d'eau	13
4. INTERFACE UTILISATEUR	14
4.1 Présentation générale	14
4.2 Réglage de l'horloge	16
4.3 Réglage de la fonction Timer	16
4.4 Choix du mode de fonctionnement	17
4.5 Réglage et visualisation du point de consigne	18
4.6 Verrouillage et déverrouillage de l'écran tactile	18
4.7 Réglage du mode SILENCE	19
5. ENTRETIEN ET HIVERNAGE	22
5.1 Entretien	22
5.2 Hivernage	22
6. ANNEXES	23
6.1 Schéma électrique	23
6.2 Raccordements priorité chauffage pompe triphasé	24
6.3 Vue éclatée et pièces détachées	26
6.4 Guide de dépannage	28
6.5 Garantie	30
6.6 Fin de vie de l'appareil	30

À lire attentivement et à conserver pour une consultation ultérieure.

Ce document doit être remis au propriétaire de la piscine et doit être conservé par celui-ci en lieu sûr.

1. CONSIGNES GÉNÉRALES - SÉCURITÉ

Nous vous remercions d'avoir acheté cette pompe à chaleur de piscine Hayward. Ce produit a été conçu selon des normes strictes de fabrication pour satisfaire aux niveaux de qualité requis. Le présent manuel inclut toutes les informations nécessaires concernant l'installation, l'élimination des dysfonctionnements et l'entretien. Lisez attentivement ce manuel avant d'ouvrir l'unité, ou de réaliser des opérations d'entretien sur celle-ci. Le fabricant de ce produit ne sera en aucun cas tenu responsable en cas de blessure d'un utilisateur ou d'un endommagement de l'unité suite à d'éventuelles erreurs lors de l'installation, de l'élimination des dysfonctionnements, ou d'un entretien inutile. Il est primordial de suivre à tout moment les instructions spécifiées dans ce manuel.

Après avoir lu ce manuel, rangez le en vue d'une utilisation ultérieure.

Personnel habilité

- L'installation, les raccordements électriques, l'entretien et les réparations de l'appareil doivent être effectués par un professionnel agréé conformément aux textes réglementaires et règles de l'art en vigueur dans le pays où l'appareil est installé (cf § 3.4). Pour toute intervention sur le circuit frigorifique, le professionnel doit être titulaire d'une attestation de capacité à la manipulation des fluides frigorigènes.

Pour la France :

- Installation électrique basse tension selon la NF-C 15-100.
- Législation sur le maniement des fluides frigorigènes : Décret 2007/737 et ses arrêtés d'application.

Conditions d'installation

- N'essayez pas d'installer vous-même cet appareil.
- Ce produit a été exclusivement conçu pour un usage domestique et une installation en extérieur. L'air qui s'échappe du produit doit pouvoir s'écouler librement et ne doit pas être utilisé à d'autres fins comme le chauffage ou le refroidissement d'une pièce ou d'un bâtiment.
- Cette pompe à chaleur réchauffe l'eau de la piscine et maintient une température constante, ne pas l'utiliser à d'autres fins.
- Vérifier le câble d'alimentation. Si le câble d'alimentation est endommagé, il doit être remplacé par le fabricant, son service après vente ou par une personne qualifiée et habilitée.
- Le raccordement de l'appareil à la terre et sa continuité sont obligatoires. Le fil de terre doit être plus long que les autres fils pour prévenir des risques d'électrisation en cas d'arrachement du câble. L'installation électrique doit obligatoirement être équipée d'une protection différentielle de 30 mA (cf § 3.4).
- Toute recommandation non suivie annule la garantie.

1. CONSIGNES GÉNÉRALES (suite)

Consignes pour l'entretien - maintenance

Les opérations de maintenance doivent être réalisées 1 fois par an afin de garantir la longévité et le bon fonctionnement de la pompe à chaleur.

- L'entretien et les différentes opérations doivent être réalisés à la fréquence et aux moments recommandés, tel que spécifié dans le présent manuel.
- N'utilisez que des pièces détachées d'origine.
- Vérifier le câble d'alimentation. Si le câble d'alimentation est endommagé, il doit être remplacé par le fabricant, son service après vente ou par une personne qualifiée et habilitée.
- Vérifier le raccordement de l'appareil à la terre et sa continuité.
- Nettoyer l'évaporateur à l'aide d'une brosse souple ou d'un jet d'air ou d'eau (**Attention ne jamais utiliser un nettoyeur haute pression**).
- Vérifier le bon écoulement des condensats.
- Vérifier le serrage des raccords hydrauliques et électriques.
- Vérifier l'étanchéité hydraulique du condenseur.
- Faire vérifier l'étanchéité du circuit frigorifique au détecteur de fuite **par un professionnel agréé**.



Avant toute opération de maintenance la pompe à chaleur doit être déconnectée de toute source de courant électrique. Les opérations de maintenance doivent être réalisées uniquement par un personnel qualifié et habilité à manipuler les fluides frigorigènes.

Consignes pour l'hivernage

- Mettre la pompe à chaleur en Mode "OFF".
- Couper l'alimentation de la pompe à chaleur.
- Vider le condenseur à l'aide de la vidange pour éviter tout risque de dégradation (risque important de gel).
- Fermer la vanne "by-pass" et dévisser les raccords unions entrée/sortie.
- Chasser au maximum l'eau stagnante résiduelle du condenseur à l'aide d'un pistolet à air.
- Obturer l'entrée et la sortie d'eau sur la pompe à chaleur pour éviter l'intrusion de corps étranger.
- Couvrir la pompe à chaleur avec la housse d'hivernage prévue à cet effet.



Tout dommage occasionné par un mauvais hivernage entraîne l'annulation de la garantie.

1. CONSIGNES GÉNÉRALES (suite)

Conditions d'utilisation

Cet appareil peut être utilisé par des enfants âgés d'au moins 8 ans ainsi que par des personnes ayant des capacités physiques, sensorielles ou mentales réduites, ou dénuées d'expérience ou de connaissance, s'ils sont correctement surveillés ou si des instructions relatives à l'utilisation de l'appareil en toute sécurité leur ont été données et si les risques encourus ont été appréhendés. Les enfants ne doivent pas jouer avec l'appareil. Le nettoyage et l'entretien par l'utilisateur ne doivent pas être effectués par des enfants sans surveillance.

Ce produit contient du gaz réfrigérant R410A

Ce produit contient des gaz à effet de serre fluorés encadrés par le protocole de Kyoto. Ne libérez pas ces gaz dans l'atmosphère.

Valeur GWP(1) : 2088, valeur basée sur le 4ème rapport du GIEC.

La quantité de réfrigérant basée sur la réglementation F Gaz 517/2014 est indiquée sur la plaque signalétique de l'unité.

Toute intervention sur le circuit frigorifique doit être effectuée par un professionnel agréé comme précisé précédemment.

Des inspections périodiques de fuite de réfrigérant peuvent être exigées en fonction de la législation européenne ou locale. Veuillez contacter votre distributeur local pour plus d'informations.

- Attention, les fluides frigorigènes peuvent être inodores.
- Ne pas percer ou chauffer la tuyauterie, risque d'explosion et de graves brûlures.
- Ne pas utiliser de moyen d'accélération du processus de dégivrage ou de nettoyage autre que ceux recommandés par le fabricant.
- L'appareil doit être stocké dans un local ne contenant pas de sources d'inflammation fonctionnant en permanence (par exemple : feux nus, appareil à gaz ou radiateur électrique en fonctionnement).

(1) Potentiel de réchauffement global

2. CARACTÉRISTIQUES TECHNIQUES

2.1 Données techniques de la pompe à chaleur



Modèle	ENERGYLINE PRO	ENP10TAS
Capacité calorifique *	kW	36,9
Puissance électrique * absorbée	kW	6,87
Courant de fonctionnement *	A	14,8
Tension d'alimentation	V / Ph / Hz	400 V / 3N~ / 50Hz
Calibre fusible type aM	A	20
Disjoncteur courbe D	A	20
Nombre de compresseurs	/	1
Type de compresseur	/	Scroll
Nombre de ventilateurs	/	2
Puissance du ventilateur	W	50 à 225
Vitesse de rotation des ventilateurs	RPM	600 à 1050
Ventilation	/	Horizontale
Niveau de pression acoustique (à 10 m), LpA	dB(A)	41
Raccordement hydraulique	mm	63
Débit d'eau nominal*	m ³ /h	13
Perte de charge sur l'eau (max)	kPa	13,8
Dimensions nettes de l'unité (L/l/h)	mm	1482 / 485 / 1480
Poids net de l'unité	kg	182

* Performance selon la norme d'essai NF EN 14511 reprise dans le référentiel NF-414.
Air sec 15°C - Humidité relative 71% - Température d'entrée d'eau 26°C.

2. CARACTÉRISTIQUES TECHNIQUES (suite)

2.2 Plage de fonctionnement

Utiliser la pompe à chaleur dans les plages suivantes de températures et d'humidité pour assurer un fonctionnement sûr et efficace.

	Mode chauffage 	Mode Refroidissement 
Température extérieure	-12°C ~ +35°C	+7°C ~ +43°C
Température d'eau	+12°C ~ +40°C	+8°C ~ +40°C
Humidité relative	< 80%	< 80%
Plage de réglage point de consigne	+15°C ~ +32°C	+8°C ~ +32°C



Si la température ou l'humidité ne correspond pas à ces conditions, des dispositifs de sécurité peuvent se déclencher et la pompe à chaleur peut ne plus fonctionner.



La température maximum de chauffage est limitée à +32° Celsius afin d'éviter la détérioration des liners. Hayward décline toutes responsabilités dans le cas d'une utilisation au delà des +32°C.

2. CARACTERISTIQUES TECHNIQUES (suite)

2.3 Dimensions

Modèle : ENP10TAS

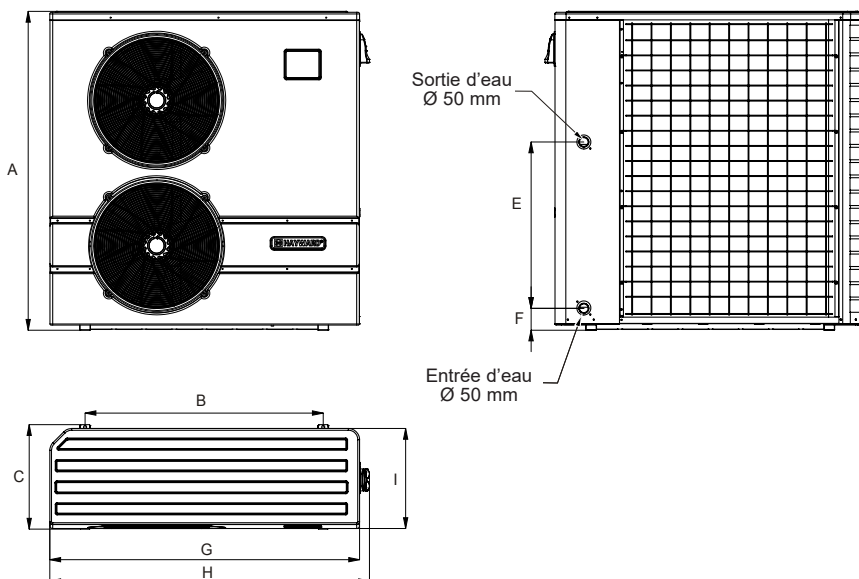

Unité : mm

Repère \ Modèle	ENP10TAS
A	1480
B	1105
C	485
D	/
E	771,5
F	101,5
G	1437
H	1483
I	464

3. INSTALLATION ET RACCORDEMENT

3.1 Schéma de principe

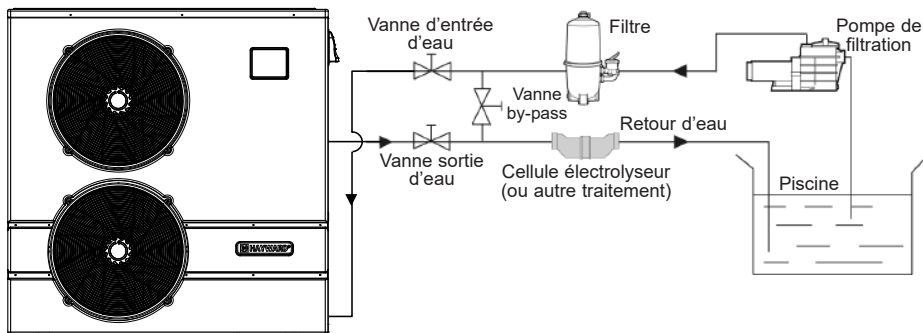

Note : La pompe à chaleur est fournie sans aucun équipement de traitement ou de filtration. Les éléments présentés sur le schéma sont des pièces à fournir par l'installateur.

3.2 Pompe à chaleur



Placer la pompe à chaleur à l'extérieur et en dehors de tout local technique fermé.

Choisir un emplacement de préférence ensoleillé et à l'abri des vents dominants.

L'appareil doit être parfaitement accessible pour les travaux d'installation et de maintenance ultérieurs.

Placée sous abri, les distances minimum prescrites ci-dessous doivent être respectées afin d'éviter tout risque de recirculation d'air et une dégradation des performances globales de la pompe à chaleur.

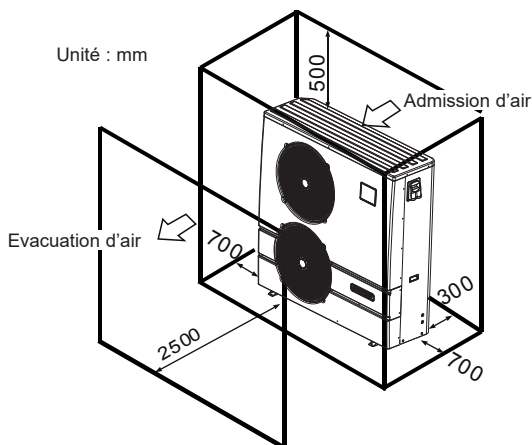

3. INSTALLATION ET RACCORDEMENT (suite)



Ne pas poser l'appareil directement au sol car cela peut être cause de troubles.

La position au sol sur des plots anti-vibrations est à privilégier.

Un support mural ne doit pas être utilisé dans des conditions susceptibles de transmettre des vibrations.

Ne pas installer la pompe à chaleur sur un support risquant d'amplifier les vibrations de l'unité.

Ne pas installer la pompe à chaleur dans un endroit susceptible d'amplifier son niveau sonore ou dans un endroit où le bruit de l'unité risquerait de gêner le voisinage.

Ne pas utiliser d'adhésifs : ceux-ci ne sont pas considérés comme des moyens de fixation fiables.

Installer de préférence la pompe à chaleur sur une dalle béton plane et désolidarisée.

Monter la pompe à chaleur sur les silentblocs fournis (visserie et rondelles fournies).

Fixer l'appareil en respectant le serrage indiqué pour éviter tout risque d'accident ou dommage pour les matériels et les personnes.

Autre possibilité : installer la pompe à chaleur sur des supports sol en caoutchouc en utilisant la visserie adaptée (non fournie).

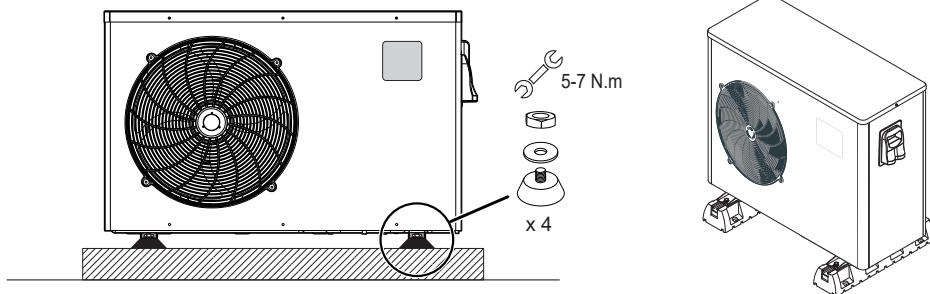

Distance maximale d'installation entre la pompe à chaleur et la piscine 15 mètres.

Longueur totale aller-retour des canalisations hydrauliques 30 mètres.

Isoler les canalisations hydrauliques de surface et enterrées.

La pompe à chaleur doit être installée à une distance minimum du bassin conformément à la NF C 15-100 (soit à 3,5 m du plan d'eau pour la France) ou conformément aux normes d'installation en vigueur dans les autres pays.

Ne pas installer la pompe à chaleur à proximité d'une source de chaleur.

En cas d'installation dans des régions neigeuses il est conseillé d'abriter la machine afin d'éviter une accumulation de neige sur l'évaporateur.

3. INSTALLATION ET RACCORDEMENT (suite)

3.3 Raccordement hydraulique

La pompe à chaleur est fournie avec deux raccords union diamètre 63 mm. Utiliser du tube PVC pour canalisation hydraulique Ø 63 mm. Raccorder l'entrée d'eau de la pompe à chaleur à la conduite venant du groupe de filtration puis raccorder la sortie d'eau de la pompe à chaleur à la conduite d'eau allant au bassin (cf schéma ci-dessous).

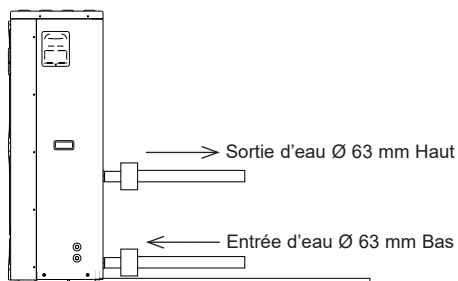

Installer une vanne dite "by-pass" entre l'entrée et la sortie de la pompe à chaleur.



Si un distributeur automatique ou un électrolyseur est utilisé, il doit impérativement être installé après la pompe à chaleur dans le but de protéger le condenseur Titane contre une concentration trop importante de produit chimique.



Veillez à bien installer la vanne by-pass et les raccords union fournis au niveau de l'entrée et de la sortie d'eau de l'unité, afin de simplifier la purge durant la période hivernale, d'en faciliter l'accès ou son démontage pour l'entretien.

3. INSTALLATION ET RACCORDEMENT (suite)

3.4 Raccordement électrique



L'installation électrique et le câblage de cet équipement doivent être conformes aux règles d'installation locales en vigueur.

F	NF C15-100	GB	BS7671:1992
D	DIN VDE 0100-702	EW	EVHS-HD 384-7-702
A	ÖVE 8001-4-702	H	MSZ 2364-702/1994/MSZ 10-553 1/1990
E	UNE 20460-7-702 1993, RECBT ITC-BT-31 2002	M	MSA HD 384-7-702.S2
IRL	Wiring Rules + IS HD 384-7-702	PL	PN-IEC 60364-7-702:1999
I	CEI 64-8/7	CZ	CSN 33 2000 7-702
LUX	384-7.702 S2	SK	STN 33 2000-7-702
NL	NEN 1010-7-702	SLO	SIST HD 384-7-702.S2
P	RSIUEE	TR	TS IEC 60364-7-702



Vérifiez que l'alimentation électrique disponible et la fréquence du réseau correspondent au courant de fonctionnement requis, en prenant en considération l'emplacement spécifique de l'appareil, et le courant nécessaire pour alimenter tout autre appareil connecté au même circuit.



ENP10TAS 400 V \sim +/- 10 % 50 Hz 3 Phases



Vérifier que l'équilibre des phases n'excède pas 2 %

Observez le schéma de câblage correspondant en annexe.

Le boîtier de raccordement se trouve du côté droit de l'unité. Trois connexions sont destinées à l'alimentation électrique, et deux à la commande de la pompe de filtration (Asservissement).

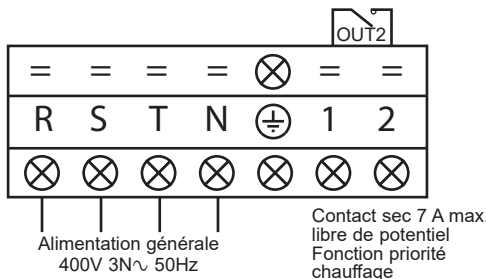

3. INSTALLATION ET RACCORDEMENT (suite)



Ne jamais utiliser de prise de courant pour l'alimentation.

La ligne d'alimentation électrique doit être dotée, de manière appropriée, d'un dispositif de protection omnipolaire de type disjoncteur courbe D ainsi que d'un disjoncteur différentiel de protection 30 mA (voir tableau après).

Modèle		ENP10TAS
Alimentation électrique	V/Ph/Hz	400V 3N~ 50Hz
Calibre fusible type aM	A	20 aM
Disjoncteur courbe D	A	20 D
Section de câble	mm ²	5G4 5 x 4



Utiliser un câble d'alimentation Type RO2V/R2V ou équivalent.



Les sections de câble sont données pour une longueur maximum de 25 m, elles doivent néanmoins être vérifiées et adaptées en fonction des conditions d'installation.



Prenez toujours garde d'arrêter l'alimentation principale avant d'ouvrir la boîte de commande électrique.

3.5 Premier démarrage

Procédure de démarrage - une fois l'installation terminée, suivez et respectez les étapes suivantes :

- 1) Faites pivoter les ventilateurs à la main afin de vérifier qu'il peut tourner librement, et que l'hélice est fixée correctement sur l'arbre du moteur.
- 2) Assurez-vous que l'unité est connectée correctement à l'alimentation principale (voir le schéma de câblage en annexe).
- 3) Activez la pompe de filtration.
- 4) Vérifiez que toutes les vannes d'eau sont ouvertes, et que l'eau s'écoule vers l'unité avant de passer en mode chauffage ou refroidissement.
- 5) Vérifiez que le tuyau de purge des condensats est fixé correctement, et ne présente aucune obstruction.
- 6) Activez l'alimentation électrique destinée à l'unité, puis appuyez sur le bouton Marche/Arrêt  sur le panneau de commande.
- 7) Assurez-vous qu'aucun code d'ALARME ne s'affiche lorsque l'unité est sur ON (voir guide de dépannage).

3. INSTALLATION ET RACCORDEMENT (suite)

- 8) Fixez le débit d'eau à l'aide de la vanne by-pass (voir § 3.6 et 2.1), tel que prévu respectivement pour chaque modèle, de manière à obtenir une différence de température Entrée/Sortie de 2°C.
- 9) Après un fonctionnement de quelques minutes, vérifiez que l'air sortant de l'unité s'est refroidi (entre 5 et 10°).
- 10) L'unité étant en service, désactivez la pompe de filtration. L'unité doit s'arrêter automatiquement et afficher le code d'erreur E03.
- 11) Faites fonctionner l'unité et la pompe de la piscine 24 heures sur 24, jusqu'à ce que la température de l'eau souhaitée soit atteinte. Quand la température d'entrée d'eau atteint la valeur de consigne, l'unité s'arrête. Elle redémarre alors automatiquement (tant que la pompe de la piscine est en service) si la température de la piscine est inférieure d'au moins 0.5°C à la température de consigne.

Contrôleur de débit - L'unité est dotée d'un contrôleur de débit qui active la pompe à chaleur lorsque la pompe de filtration de la piscine est en service, et la désactive lorsque la pompe de la filtration est hors service. Par manque d'eau, le code d'alarme E03 s'affiche sur le régulateur (Voir § 6.4).

Temporisation - l'unité intègre une temporisation de 3 minutes, afin de protéger les composants du circuit de commande, d'éliminer toute instabilité en terme de redémarrage et, toute interférence au niveau du contacteur. Grâce à cette temporisation, l'unité redémarre automatiquement 3 minutes environ après toute coupure du circuit de commande. Même une coupure de courant de courte durée active la temporisation de démarrage.

Contrôleur de phase - Les unités Triphasés intègre un contrôleur de phase pour garantir le bon sens de rotation du compresseur. Si l'unité ne démarre pas, vérifier l'état du contrôleur de phase situé dans le coffret électrique.

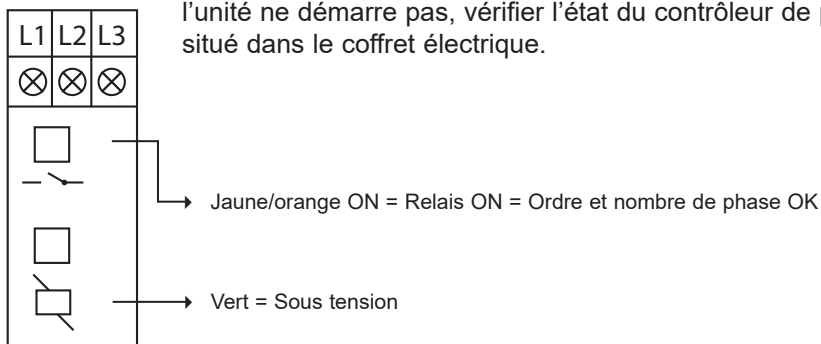

3. INSTALLATION ET RACCORDEMENT (suite)

3.6 Réglage du débit d'eau

Les vannes d'entrée et de sortie d'eau étant ouvertes, ajuster la vanne dite "by-pass" de façon à obtenir une différence de 2°C entre la température d'entrée et de sortie d'eau (voir schéma de principe § 3.1). Vous pouvez vérifier le réglage en visualisant les températures entrée/sortie directement sur le panneau de commande.

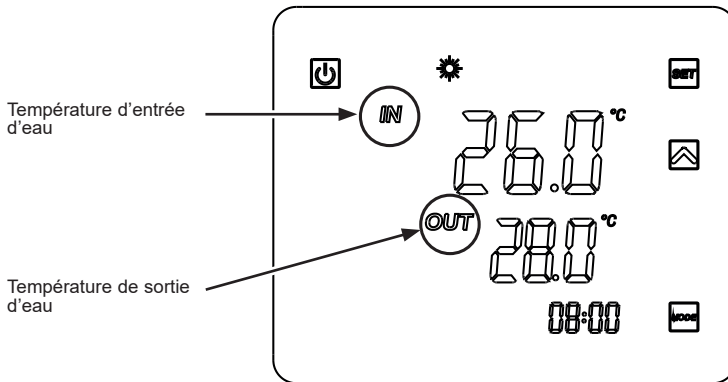

Note : L'ouverture de la vanne dite "by-pass" engendre un débit moins important d'où une augmentation du ΔT .
La fermeture de la vanne dite "by-pass" engendre un débit plus important d'où une diminution du ΔT .

4. INTERFACE UTILISATEUR

4.1 Présentation générale

La pompe à chaleur est équipée d'un panneau de commande digital à écran tactile, raccordé électriquement et pré-réglé en usine en mode chauffage.

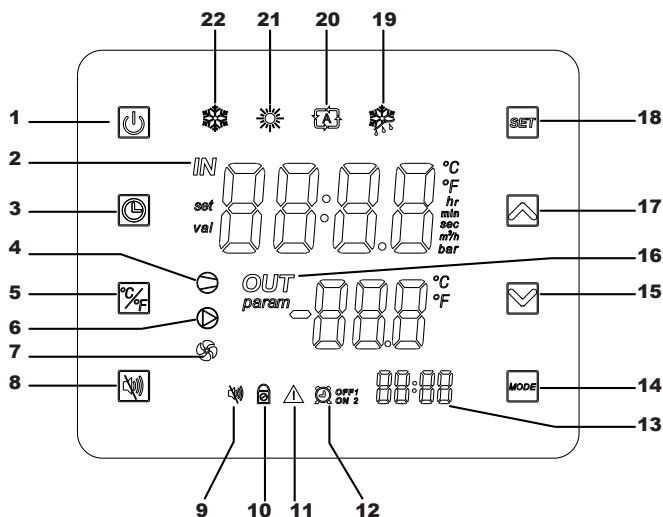

Légende

1		Marche / Arrêt	12		Timers 1 et 2
2		Entrée d'eau	13		Heure des Timers
3		Réglage heure et Timers	14		Sélection du mode
4		Compresseur ON	15		Défilement bas / Diminuer
5		Conversion °C/°F	16		Sortie d'eau
6		Contact sec OUT2	17		Défilement haut / Augmenter
7		Ventilateur ON	18		Sauvegarde / Réglages
8		Mode silence	19		Mode dégivrage
9		Témoin mode silence	20		Mode automatique
10		Écran verrouillé	21		Mode chauffage
11		Alarme	22		Mode refroidissement

4. INTERFACE UTILISATEUR (suite)

Mode OFF

Lorsque la pompe à chaleur est en veille (Mode OFF) l'inscription "OFF" est affichée sur l'écran du régulateur.

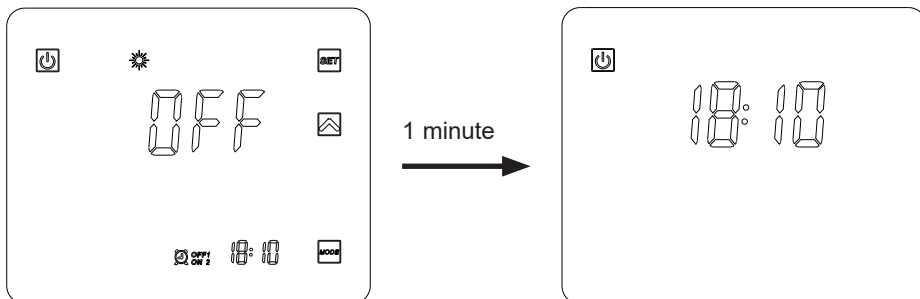

Mode ON

Lorsque la pompe à chaleur est en fonctionnement ou en régulation (Mode ON) les températures d'entrée et de sortie d'eau sont affichées sur l'écran du régulateur.

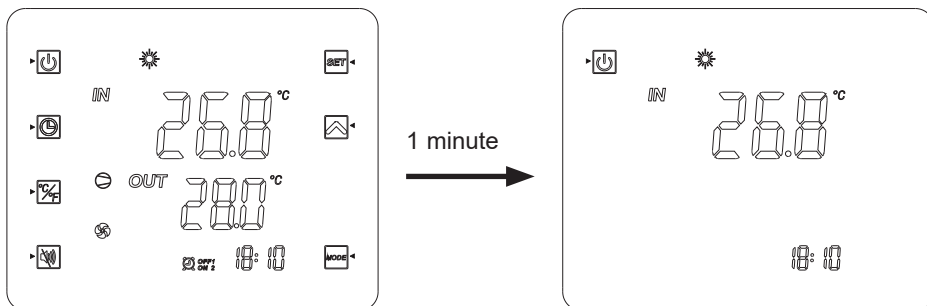









4. INTERFACE UTILISATEUR (suite)

A la fin des réglages, presser sur  pour valider.

L'enregistrement des réglages est automatique au bout de 20s sans action.

4.2 Réglage de l'horloge

Si l'afficheur est en mode veille, appuyer brièvement sur le bouton .









- 1) Presser sur  pour faire apparaître le symbole .
- 2) Presser sur , l'affichage de l'heure clignote. Régler les heures à l'aide des boutons  .
- 3) Presser sur  puis régler les minutes à l'aide des boutons  .
- 4) Valider en pressant sur .

4.3 Réglage de la fonction Timer











Le réglage de cette fonction est nécessaire dès lors que vous souhaitez faire fonctionner votre pompe à chaleur sur une plus courte période que celle définie par l'horloge de filtration. Ainsi vous pourrez programmer un départ différé et un arrêt anticipé ou simplement interdire une plage horaire de fonctionnement (par exemple la nuit).



Vous avez la possibilité de programmer 2 Timers Départ (ON1 et ON2) et 2 Timers Arrêt (OFF1 et OFF2).

Programmation du Timer 1 – Départ

- 1) Presser  pendant 2s, le Timer ON1  clignote (*).
- 2) Presser sur  pour régler les heures à l'aide des boutons  .
- 3) Presser sur  pour régler les minutes à l'aide des boutons  .
- 4) Valider en pressant sur .



Programmation du Timer 1 – Arrêt

- 1) Presser  pendant 2s, le Timer ON1  clignote (*).
Presser 1 fois sur , le Timer OFF1  clignote.
- 2) Presser sur  pour régler les heures à l'aide des boutons  .
- 3) Presser sur  pour régler les minutes à l'aide des boutons  .
- 4) Valider en pressant sur .



(*) Pour accéder directement au Timer ON2 , presser  pendant 2s, puis presser 2 fois sur .

4. INTERFACE UTILISATEUR (suite)













Programmation du Timer 2



Après les réglages du Timer 1, vous accédez directement aux réglages du Timer 2 :  et .

Procédez de la même façon que pour le Timer 1.

Nota: Pour accéder directement au Timer ON2 , presser  pendant 2s, puis presser 2 fois sur .

Suppression des Timers (Départ et Arrêt)

- 1) Presser  pendant 2s, le Timer  clignote.*)
- 2) Presser sur , l'affichage de l'heure clignote.
- 3) Presser sur  pour supprimer le Timer .
- 4) Presser  pour valider.
- 5) Presser  pendant 2s, le Timer  clignote.
Presser 1 fois sur , le Timer  clignote.*)
- 6) Presser sur , l'affichage de l'heure clignote.
- 7) Presser sur  pour supprimer le Timer .

(*) Pour accéder aux Timers 2  ou , suivre les étapes **1) à 4)** puis appuyer 2 fois sur . Procéder de la même façon que ci-dessus.

4.4 Choix du mode de fonctionnement

En Mode "OFF" ou "ON"

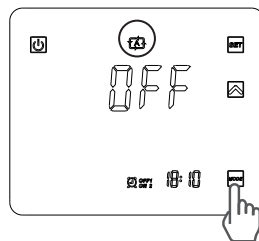
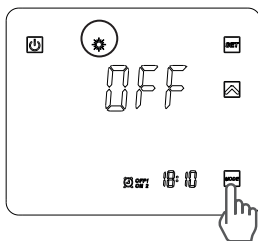
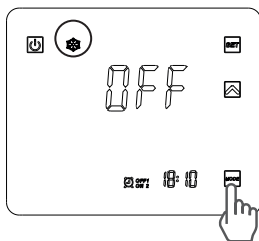

Presser le bouton  pour changer de mode : refroidissement, chauffage ou automatique.



Si la pompe à chaleur est réglée en mode Chaud Seul ou Froid Seul, le changement de mode n'est pas valide.



4. INTERFACE UTILISATEUR (suite)

4.5 Réglage et visualisation du point de consigne (Température d'eau souhaitée)

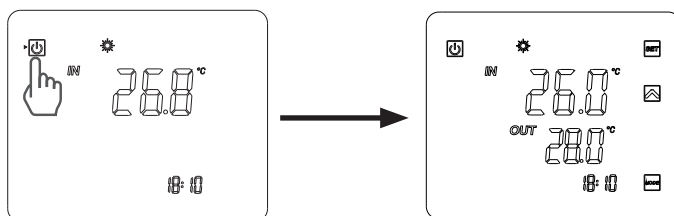
Si le bouton  n'est pas visible à l'écran, appuyer brièvement sur .
(En fonctionnement ou à l'arrêt, il suffit de presser le bouton  pour visualiser le point de consigne.)





En Mode “OFF” et Mode “ON”



Presser le bouton  pour afficher le point de consigne, puis presser sur  ou  pour définir le point de consigne souhaité.
Le réglage s'effectue avec une précision de 0,5 °C.



Il est recommandé de ne jamais dépasser la température de 30°C pour éviter l'altération des liners.

4.6 Verrouillage et déverrouillage de l'écran tactile

Presser le bouton  pendant 5s jusqu'à l'émission d'un bip et l'apparition du symbole .

Pour déverrouiller, presser  pendant 5s jusqu'à l'émission d'un bip et la disparition du symbole .

4. INTERFACE UTILISATEUR (suite)

4.7 Réglage du mode SILENCE

Cette fonction permet l'utilisation de la pompe à chaleur sous une vitesse de rotation des ventilateurs réduite à 600Tr/min pendant une durée de 8 heures maximum, ceci afin de limiter les nuisances sonores en période nocturne et ou diurne selon la localisation de la pompe à chaleur par rapport au voisinage et ou du bassin.



Cette fonction peut être Activée/Désactivée soit manuellement, soit à l'aide d'un Timer.

Activation manuelle

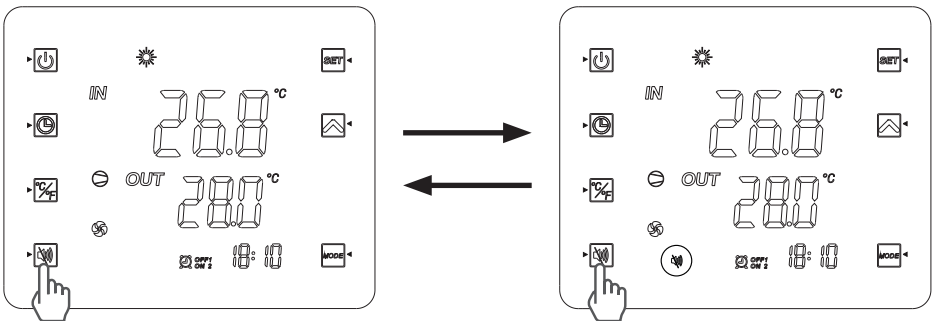
- 1) Appuyer sur le bouton .
- 2) L'affichage ci-dessous apparaît à l'écran, le mode Silence est activé pour les 8 prochaines heures.
- 3) Les ventilateurs réduisent progressivement leur vitesse de rotation pour une durée de 8 heures maximum.
- 4) Après 8 heures de fonctionnement la fonction sera automatiquement désactivée et les ventilateurs reprendront une vitesse de rotation en fonction de la température de l'air extérieure.





Désactivation manuelle

- 1) Appuyer sur le bouton .
- 2) Le témoin  disparaît de l'écran : le mode Silence est désactivé.
- 3) Les ventilateurs ajustent leur vitesse de rotation en fonction de la température de l'air extérieur.

4. INTERFACE UTILISATEUR (suite)



Programmation du mode SILENCE

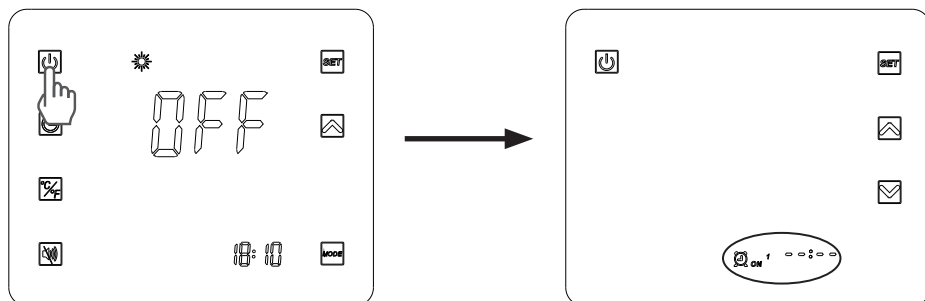

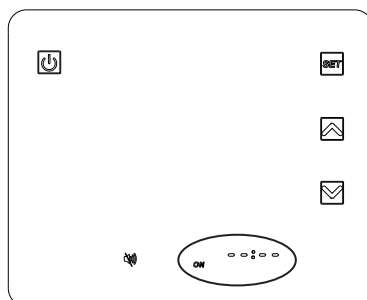

1) Presser  pendant 2s : le Timer ON1  clignote.



2) Presser 4 fois sur  jusqu'à l'écran ci-dessous.









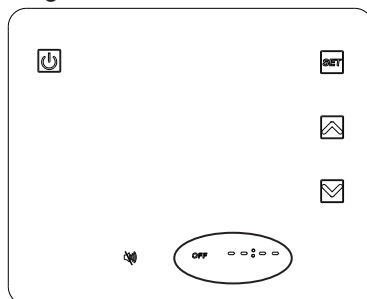

3) Presser sur , l'affichage des heures clignote. Utiliser les flèches   pour régler l'heure du début.

4) Presser sur , l'affichage des minutes clignote. Utiliser les flèches   pour régler les minutes du début. Valider en pressant sur .

5) Presser sur  pour régler l'heure de fin : l'indication **OFF** clignote.



4. INTERFACE UTILISATEUR (suite)

- 6) Presser sur  l'affichage des heures clignote. Utiliser les flèches   pour régler l'heure de fin.
- 7) Presser sur  l'affichage des minutes clignote. Utiliser les flèches   pour régler les minutes de fin. Valider en pressant sur .
- 8) Presser  pour revenir à l'écran précédent.
Les indications ON-OFF s'affichent comme ci-dessous.

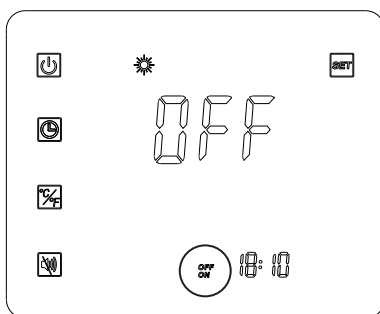

Nota : Le pas de réglage des minutes est de 10 en 10.

Une fois le réglage du mode SILENCE terminé, celui-ci est actif par défaut 7j/7j.

5. ENTRETIEN ET HIVERNAGE

5.1 Entretien

Ces opérations de maintenance doivent être réalisées 1 fois par an afin de garantir la longévité et le bon fonctionnement de la pompe à chaleur.

- L'entretien et les réparations de l'appareil doivent être effectués par un professionnel agréé conformément aux textes réglementaires et règles de l'art en vigueur dans le pays où l'appareil est installé (cf § 3.4). Pour toute intervention sur le circuit frigorifique, le professionnel doit être titulaire d'une attestation de capacité à la manipulation des fluides frigorigènes.
- Vérifier le câble d'alimentation. Si le câble d'alimentation est endommagé, il doit être remplacé par le fabricant, son service après vente ou par une personne qualifiée et habilitée.
- Vérifier le raccordement de l'appareil à la terre et sa continuité.
- Nettoyer l'évaporateur à l'aide d'une brosse souple ou d'un jet d'air ou d'eau. **Attention ne jamais utiliser un nettoyeur haute pression.**
- Vérifier le bon écoulement des condensats.
- Vérifier le serrage des raccords hydrauliques et électriques
- Vérifier l'étanchéité hydraulique du condenseur.
- Faire vérifier l'étanchéité du circuit frigorifique au détecteur de fuite **par un professionnel agréé.**



Avant toute opération de maintenance la pompe à chaleur doit être déconnectée de toute source de courant électrique. Les opérations de maintenance doivent être réalisées uniquement par un personnel qualifié et habilité à manipuler les fluides frigorigènes.

5.2 Hivernage

- Mettre la pompe à chaleur en Mode "OFF".
- Couper l'alimentation de la pompe à chaleur.
- Vider le condenseur à l'aide de la vidange pour éviter tout risque de dégradation (risque important de gel).
- Fermer la vanne "by-pass" et dévisser les raccords unions entrée/sortie.
- Chasser au maximum l'eau stagnante résiduelle du condenseur à l'aide d'un pistolet à air.
- Obturer l'entrée et la sortie d'eau sur la pompe à chaleur pour éviter l'intrusion de corps étranger.
- Couvrir la pompe à chaleur avec la housse d'hivernage prévue à cet effet.



Tout dommage occasionné par un mauvais hivernage entraîne l'annulation de la garantie.

6. ANNEXES

6.1 Schéma électrique

ENP10TAS

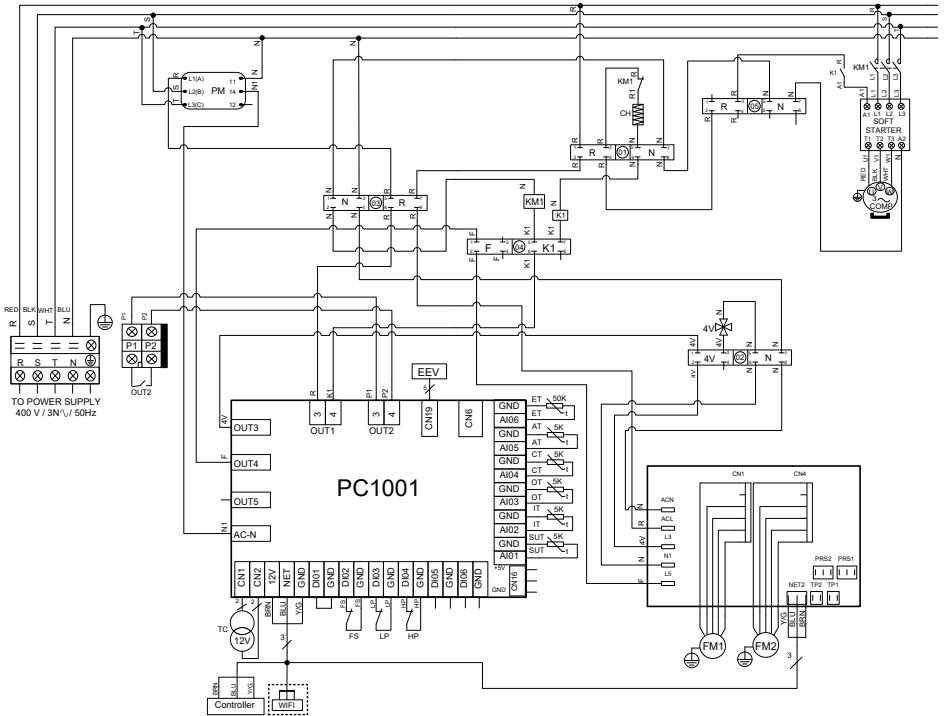

REMARQUES :

- AT : SONDE DE TEMPÉRATURE D'AIR
- COMP : COMPRESSEUR
- CT : SONDE TEMPÉRATURE ÉVAPORATEUR
- EEV : DÉTENDEUR ÉLECTRONIQUE
- FM1-2 : MOTEUR VENTILATEUR
- FS : DÉTECTEUR PRÉSENCE D'EAU
- HP : PRESSOSTAT HAUTE PRESSION
- IT : SONDE DE TEMPÉRATURE ENTRÉE D'EAU
- LP : PRESSOSTAT BASSE PRESSION

- OT : SONDE DE TEMPÉRATURE SORTIE D'EAU
- SUT : SONDE DE TEMPÉRATURE D'ASPIRATION
- TC : TRANSFORMATEUR 230V~/ 12V~
- 4V : VANNE 4 VOIES
- KM1 : CONTACTEUR DE PUISSANCE COMPRESSEUR
- PM : CONTRÔLEUR DE PHASE
- CH1 : RÉSISTANCE DE CARTER
- OUT2 : CONTACT SEC MAX. 7 A
- ET : SONDE TEMPÉRATURE REFOULEMENT
- [] : OPTION

6. ANNEXES (suite)

6.2 Raccordements priorité chauffage pompe triphasé

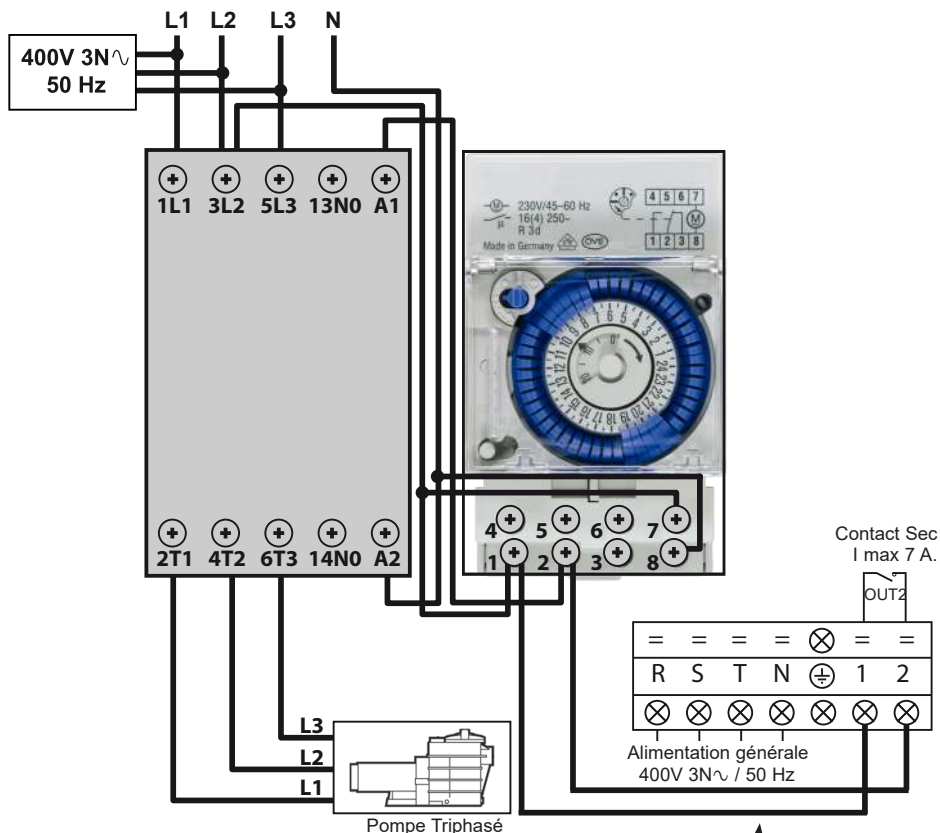

Les bornes 1-2 délivrent un contact sec libre de potentiel, sans polarité 230 V \sim / 50 Hz.
Câbler les bornes 1 et 2 en respectant le câblage indiqué ci-dessus afin d'asservir le fonctionnement de la pompe de filtration par cycle de 2 min. toutes les heures si la température du bassin est inférieure au point de consigne.

 Ne jamais raccorder l'alimentation de la pompe de filtration directement sur les bornes 1 et 2.



Page laissée blanche intentionnellement

6. ANNEXES (suite)

6.3 Vue éclatée et pièces détachées

ENP10TAS

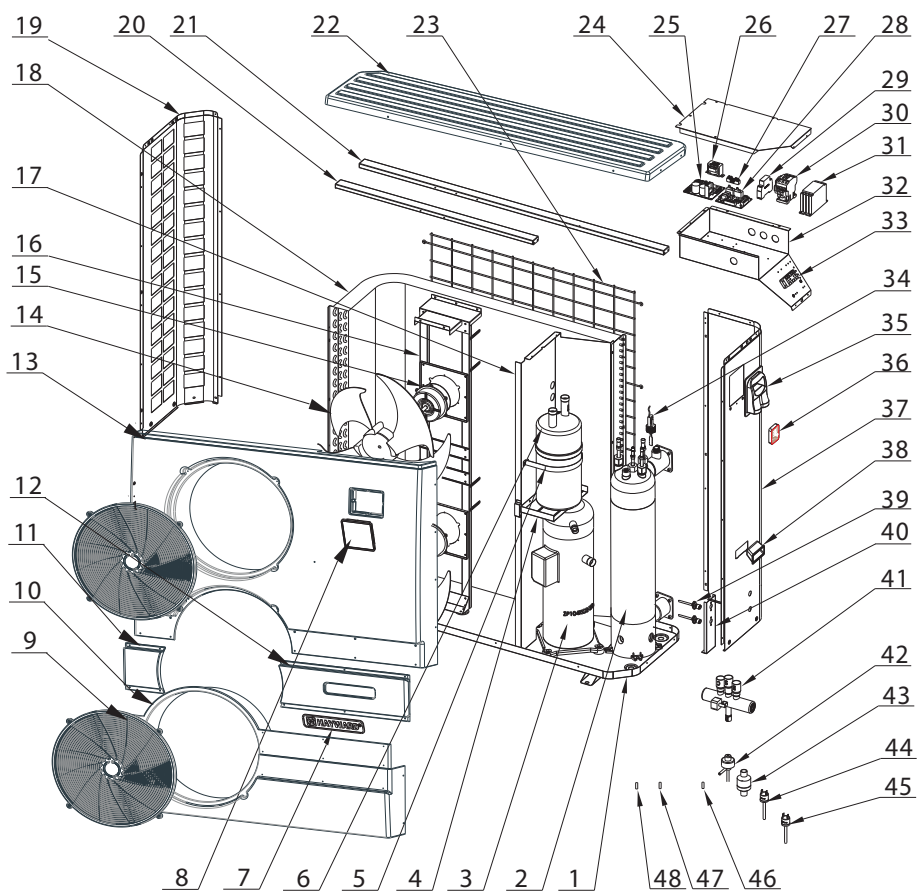

6. ANNEXES (suite)

ENP10TAS

Rep	Réf.	Désignation	Rep	Réf.	Désignation
1	HWX32005210049	Fond	27	HWX20003909	Bornier 2 connexions
2	HWX32005120009	Condenseur Titane/PVC	28	HWX950531014516	Carte électronique
3	HWX20000110153	Compresseur	29	HWX200036023	Contrôleur de phase
4	HWX32027210011	Support Réservoir liquide	30	HWX20000360209	Contacteur compresseur Tri
5	HWX32027210013	Collier serrage	31	HWX20000360092	Démarrateur électronique Tri
6	HWX35141402	Réservoir de liquide	32	HWX32005210054	Coffret électrique
7	HWX20000230596	Logo Hayward	33	HWX20000390180	Bornier 5 connexions Tri
8	HWX95005010018	Régulateur LED	34	HWX200036005	Détecteur de débit d'eau
9	HWX32020220001	Grille de protection ventilateur	35	HWX32009220032	Trappe d'accès électrique
10	HWX32005220002	Panneau avant inférieur	36	HWX95005010014	Module WiFi
11	HWX32005220005	Panneau décoratif gauche	37	HWX32005210060	Panneau droit
12	HWX32005220004	Panneau décoratif droit	38	HWX32008220037	Poignée
13	HWX32005220001	Panneau avant supérieur	39	HWX20000140353	Prise de pression HP/BP
14	HWX20000270025	Hélice ventilateur	40	HWX32019210038	Plaque support prises HP/BP
15	HWX20000330361	Moteur DC	41	HWX20011488	Vanne 4 voies
16	HWX32005210058	Support moteur	42	HWX20000140338	Détendeur électronique
17	HWX32005210065	Panneau de séparation	43	HWX20041455	Filtre
18	HWX32005120008	Evaporateur	44	HWX20003603	Pressostat basse pression
19	HWX32005210051	Panneau gauche	45	HWX20013605	Pressostat haute pression
20	HWX32005220055	Raidisseur court	46/47	HWX20003242	Sonde Temp Air/Eau/ Evaporateur
21	HWX32005210056	Raidisseur large	48	HWX20003223	Sonde compresseur 50 kΩ
22	HWX32005220003	Panneau supérieur	*49*	HWX20000240208	Couverture d'hivernage
23	HWX32005210063	Protection évaporateur	*50*	HWX200026009	Joint torique ID48-EP 5 mm
24	HWX32005210053	Panneau de protection électrique	*51*	HWX200026061	Joint torique ID43-EP 3,4 mm
25	HWX950531024107	Module DC Inverter	*52*	HWX20003214	Résistance de carter
26	HWX200037003	Transformateur 230V _~ - 12V _~	*53*	HWX20002625	Silent bloc

Nota : Les repères *xx* ne sont pas référencés sur la vue éclatée correspondante.

6. ANNEXES (suite)

6.4 Guide de dépannage



Certaines opérations doivent être réalisées par un technicien habilité.

En cas de défaut, les indications suivantes s'affichent à l'écran :

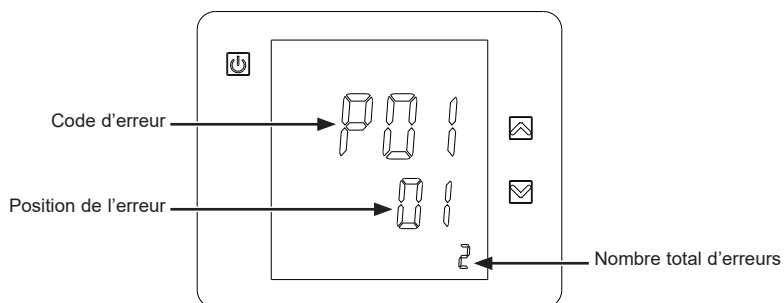

En cas d'erreur multiple, pressez sur  ou  pour faire défiler les codes d'erreur. Reportez vous au tableau ci-après.

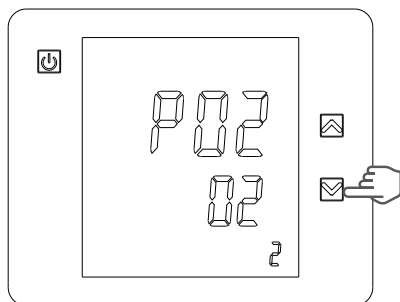

6. ANNEXES (suite)

Dysfonctionnement	Codes d'erreur	Description	Solution
Défaut sonde entrée d'eau	P01	Le capteur est ouvert ou présente un court-circuit.	Vérifier ou remplacer le capteur.
Défaut sonde sortie d'eau	P02	Le capteur est ouvert ou présente un court-circuit.	Vérifier ou remplacer le capteur.
Défaut sonde de dégivrage	P05	Le capteur est ouvert ou présente un court-circuit.	Vérifier ou remplacer le capteur.
Défaut sonde température extérieure	P04	Le capteur est ouvert ou présente un court-circuit.	Vérifier ou remplacer le capteur.
Défaut sonde compresseur	P07	Le capteur est ouvert ou présente un court-circuit.	Vérifier ou remplacer le capteur.
Différence de température trop grande entre l'eau en sortie et l'eau en entrée	E06	Débit d'eau en volume insuffisant, différence de pression d'eau trop faible / trop élevée.	Vérifier le débit d'eau, ou l'obstruction du système.
Protection Antigel Mode froid	E07	Quantité d'eau sortante trop faible.	Vérifier le débit d'eau, ou le capteur de température d'eau sortante.
Protection antigel de niveau 1	E19	Température ambiante, ou de l'eau entrante trop faible.	
Protection antigel de niveau 2	E29	Température ambiante, ou de l'eau entrante encore plus faible.	
Protection haute pression	E01	Pression du circuit frigorifique trop élevée, ou débit d'eau trop faible, ou évaporateur obstrué, ou débit d'air trop faible.	Vérifier le pressostat haute pression et la pression du circuit frigorifique. Vérifier le débit d'eau ou d'air. Vérifier le bon fonctionnement du contrôleur de débit. Vérifier l'ouverture des vannes entrée/sortie d'eau. Vérifier le réglage du by-pass.
Protection basse pression	E02	Pression du circuit frigorifique trop faible, ou débit d'air trop faible ou évaporateur obstrué.	Vérifiez le pressostat basse pression et la pression du circuit frigorifique pour évaluer s'il existe une fuite. Nettoyer la surface de l'évaporateur. Vérifier la vitesse de rotation du ventilateur. Vérifier la libre circulation de l'air à travers l'évaporateur.
Défaut détecteur de débit	E03	Débit d'eau insuffisant ou détecteur en court circuit ou défectueux	Vérifiez le débit d'eau, vérifiez la pompe de filtration et le détecteur de débit pour voir s'ils présentent d'éventuels dysfonctionnements.
Problème de communication	E08	Dysfonctionnement du contrôleur LED ou de la connexion PCB.	Vérifier la connexion des câbles NET et NET 1.
Le compresseur ne démarre pas	E08	Manque une phase ou ordre des phases incorrecte	Vérifier la présence des (3) phases Modifier l'ordre des phases au niveau du bornier de raccordement électrique de la pompe à chaleur.

6. ANNEXES (suite)

6.5 Garantie

CONDITIONS DE GARANTIE

Tous les produits HAYWARD sont garantis contre tous vices de fabrication ou de matière pendant une période de deux années à compter de la date d'achat. Toute demande de garantie devra être accompagnée d'une preuve d'achat justifiant sa date. Nous vous incitons donc à conserver votre facture.

La garantie HAYWARD est limitée à la réparation ou au remplacement, au choix d'HAYWARD, des produits défectueux pour autant qu'ils aient subi un emploi normal, en accord avec les prescriptions mentionnées dans leur manuel d'utilisation, que le produit n'ait été modifié d'aucune sorte et utilisé uniquement avec des composants et des pièces HAYWARD. Les dommages dûs au gel et aux attaques d'agents chimiques ne sont pas garantis.

Tous les autres frais (transport, main d'œuvre...) sont exclus de la garantie.

HAYWARD ne pourra être tenu pour responsable d'aucun dommage direct ou indirect provenant de l'installation, du raccordement ou du fonctionnement incorrect d'un produit.

Pour faire jouer une garantie et demander la réparation ou le remplacement d'un article, adressez vous à votre revendeur. Aucun retour de matériel à notre usine ne sera accepté sans notre accord écrit préalable.

Les pièces d'usure ne sont pas couvertes par la garantie.

6.6 Fin de vie de l'appareil



Le symbole de la poubelle barrée relatif au traitement et à la revalorisation des déchets électriques et électroniques signifie qu'en aucun cas les produits ne doivent être jetés avec les ordures ménagères, avec les encombrants ou dans une décharge.

En fin de vie, l'appareil doit faire l'objet d'une collecte sélective en vue de son recyclage ou de sa revalorisation. Un circuit spécifique de récupération pour ce type de produits est mis en place dans les pays de l'Union Européenne et en Norvège.

Contactez l'installateur ou le représentant local pour procéder à la collecte, au démantèlement et recyclage de cet appareil.

Le retraitement du liquide réfrigérant, de l'huile et des autres pièces doit être réalisé par un professionnel qualifié agréé conformément aux législations locales et nationales en vigueur.

Si le produit renferme des piles qui portent ce symbole, cela signifie que les piles peuvent contenir des substances nocives ou polluantes. Dans ce cas, déposez les piles dans un point de collecte de piles usagées.

ENERGYLINE PRO

SWIMMING POOL HEAT PUMP UNIT



ENP10TAS

Installation & Instruction Manual

CONTENTS

1. GENERAL INSTRUCTIONS - SAFETY	1
2. SPECIFICATIONS	4
2.1 Technical data for the swimming pool heat pump unit	4
2.2 Operating range	5
2.3 Dimensions	6
3. INSTALLATION AND CONNECTION	7
3.1 Functional Diagram	7
3.2 Heat pump	7
3.3 Hydraulic connection	9
3.4 Electrical connection	10
3.5 Initial start-up	11
3.6 Water flow setting	13
4. USER INTERFACE	14
4.1 General presentation	14
4.2 Clock settings	16
4.3 Timer function settings	16
4.4 Operation mode selection	17
4.5 Setting and visualisation of the set point	18
4.6 Locking and unlocking the touch screen	18
4.7 Silent function settings	19
5. MAINTENANCE AND WINTERISING	22
5.1 Maintenance	22
5.2 Winterising	22
6. APPENDIX	23
6.1 Electrical diagram	23
6.2 Heating priority wiring for three phases pump	24
6.3 Exploded view and spare parts	26
6.4 Troubleshooting guide	28
6.5 Warranty	30
6.6 End of life of the device	30

Please read attentively and save for future consultation.

This document must be given to the pool owner and should be kept in a safe place.

1. GENERAL INSTRUCTIONS - SAFETY

We thank you for purchasing this Hayward swimming pool heat pump unit. This product has been designed in compliance with strict manufacturing standards to meet the required quality levels. This manual includes all the information you need for installing, troubleshooting and maintenance. Read this manual carefully before opening the unit or performing any maintenance operations. The manufacturer of this product will in no way be held liable for any injuries to a user or damage to the unit resulting from incorrect installation, troubleshooting and repairs or poor maintenance. It is essential to follow the instructions given in this manual at all times.

After having read this manual, keep it for future usage.

Authorised personnel

- The installation, electrical connections, maintenance and repairs of the device must be carried out by an accredited professional in accordance with the regulatory texts and the rules of the art in effect in the country where the device is installed (see § 3.4).

For any intervention on the cooling circuit, the professional must hold a certificate of competence in handling refrigerants.

For France:

- Low-voltage electrical installation according to NF-C 15-100.
- Legislation on the handling of refrigerants: Decree 2007/737 and its implementation orders.

Installation and maintenance conditions

- Do not attempt to install this device by yourself.
- This product was designed exclusively for domestic use and installation outdoors. The air that escapes from the product must be able to flow freely and must not be used for other purposes such as heating or cooling a room or building.
- This swimming pool heat pump unit heats swimming pool water and maintains a constant temperature; it should not be used for any other purpose.
- Check the power cable. If the power cable is damaged, it has to be replaced by the manufacturer, its after-sales service or by a qualified and authorised person.
- Grounding connection of the device and its continuity are mandatory. The ground wire has to be longer than the other wires in order to prevent the risks of electric shock in the event the cable is pulled out. The electrical installation must be equipped with a differential protection of 30 mA (see § 3.4).
- Failure to comply with these recommendations will invalidate the warranty.

1. GENERAL INSTRUCTIONS - SAFETY (continued)

Instructions for servicing - maintenance

Maintenance operations must be carried out once per year in order to guarantee the longevity and the good working condition of the heat pump.

- Maintenance and the different operations must be carried out at the recommended times and frequencies as specified in this manual.
- Only use genuine spare parts.
- Check the power cable. If the power cable is damaged, it has to be replaced by the manufacturer, its after-sales service or by a qualified and authorised person.
- Verify the grounding connection of the device and its continuity.
- Clean the coil with the help of a soft brush or jet of air or water (**Warning, never use a high pressure cleaner**).
- Verify that the drains flow well.
- Verify the tightening of the hydraulic and electrical connections
- Verify the hydraulic sealing of the condenser.
- Have the leak-tightness of the cooling circuit to the leak detector checked by an **accredited professional**.



Before any maintenance operation, the heating pump must be disconnected from any electrical current source. The maintenance operations must only be carried out by personnel that is qualified and authorised to handle liquid refrigerants.

Instructions for winterising

- Put the heat pump in “OFF” mode.
- Cut the power supply to the heat pump.
- Empty the condenser with the help of the drain to avoid any risk of deterioration. (high risk of freezing).
- Close the by-pass valve and unscrew the entry/exit connection unions.
- Eliminate the maximum amount of residual stagnant water from the condenser with the help of an air gun.
- Close the water entry and exit areas of the heating pump to avoid introducing foreign bodies.
- Cover the heating pump with a dedicated winterising case.



Any damage caused by poor winterising maintenance will lead to cancellation of the warranty.

1. GENERAL INSTRUCTIONS - SAFETY (continued)

Conditions for use

This device can be used by children aged 8 years and over as well as by persons who have reduced, physical, sensory or mental capacities, or who lack experience or knowledge, if they are correctly monitored or if instructions pertaining to the use of the device in complete safety have been given to them and the risks incurred are understood.

Children must not play with the device.

Cleaning and maintenance by the user must not be carried out by children without surveillance.

This product contains refrigerant gas R410A

This product contains greenhouse effect fluorinated gases covered by the Kyoto protocol. Do not release these gases into the atmosphere.

GWP Value⁽¹⁾: 2088, Value based on the 4th GIEC report.

The quantity of refrigerant, based on the F-Gas regulation no. 517/2014, is stated on the unit's rating plate.

Any intervention on the cooling circuit must be carried out by an accredited professional as mentioned hereinabove.

Periodic inspections for refrigerant leakage can be required as a function of European or local legislation. Please contact your local distributor for additional information.

- Warning, refrigerants can be odourless.
- Do not pierce or heat the pipes, risk of explosion and serious burns.
- Do not use a method for accelerating the defrosting or cleaning process other than those recommended by the manufacturer.
- The device must be stored in a room that does not contain any source of ignition operating on a permanent basis (for example, open flames, gas device or electric radiator that is operating).

⁽¹⁾ Global warming potential

2. SPECIFICATIONS

2.1 Technical data for the swimming pool heat pump unit



Model	ENERGYLINE PRO	ENP10TAS
Heating capacity*	kW	36,9
Absorbed electrical power *	kW	6,87
Running current*	A	14,8
Power supply	V / Ph / Hz	400 V / 3N~ / 50Hz
aM type fuse calibre	A	20
Curve D circuit breaker	A	20
Compressor quantity	/	1
Type of compressor	/	Scroll
Fan quantity	/	2
Fan power	W	50 - 225
Fan rotation speed	RPM	600 - 1050
Ventilation	/	Horizontal
Sound pressure level (at 10 m) LpA	dB(A)	41
Hydraulic connection	mm	63
Nominal water flow*	m ³ /h	13
Water pressure drop (max)	kPa	13,8
Unit net dimensions (L/I/h)	mm	1482 / 485 / 1480
Net weight per unit	kg	182

* Performance in accordance with test standard NF EN 14511 detailed in the NF-414 repository. Dry air 15°C - Relative humidity 71% - Incoming water temperature 26°C.

2. SPECIFICATIONS (continued)

2.2 Operating range

Use the swimming pool heat pump unit within the following ranges of temperature and humidity to ensure safe and efficient operation.

	Heating mode 	Cooling mode 
Outside temperature	-12°C ~ +35°C	+7°C ~ +43°C
Water temperature	+12°C ~ +40°C	+8°C ~ +40°C
Relative humidity	< 80%	< 80%
Setting range from the set point	+15°C ~ +32°C	+8°C ~ +32°C



If the temperature or humidity does not correspond to these conditions, the security measures could be activated and the swimming pool heat pump unit may no longer work.



The maximum heating temperature is set at 32°C to prevent damage to the liners. Hayward cannot be held responsible if used at a temperature above +32°C.

2. SPECIFICATIONS (continued)

2.3 Dimensions

Model: ENP10TAS

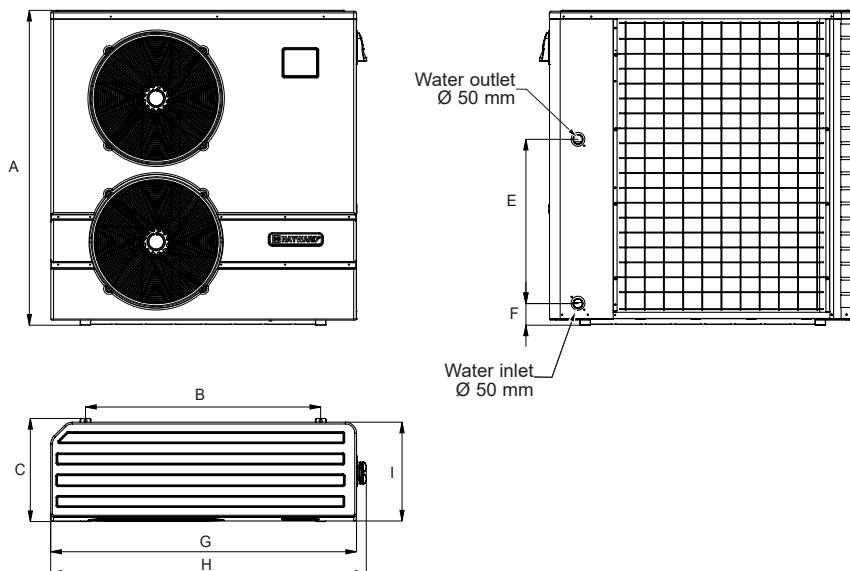

Unit: mm

Mark \ Model	Model	ENP10TAS
A		1480
B		1105
C		485
D		/
E		771.5
F		101.5
G		1437
H		1483
I		464

3. INSTALLATION AND CONNECTION

3.1 Functional Diagram

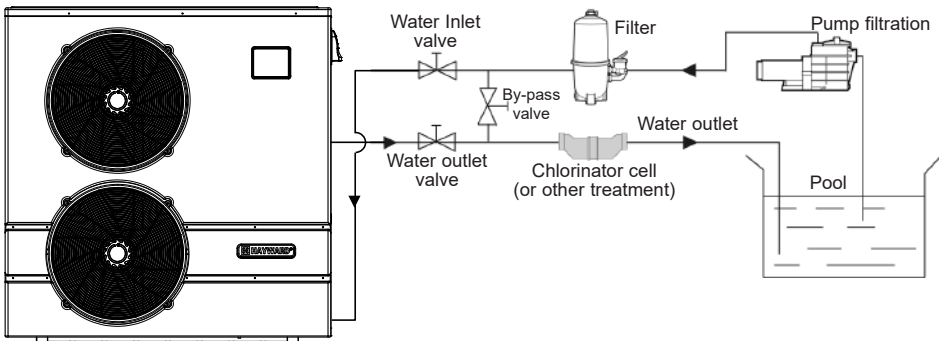

Note: The swimming pool heat pump unit is sold without any treatment or filtration equipment. The components shown on the diagram are parts to be supplied by the installation engineer.

3.2 Heat pump



Place the heat pump outdoors and away from any enclosed technical space.

Choose a location that is preferably sunlit and sheltered from dominant winds.

The device must be perfectly accessible for later installation and maintenance work.

Placed under a shelter, the minimum required distances mentioned below must be respected in order to avoid any risk of air recirculation and a deficiency in the unit's overall performance.

Unit: mm

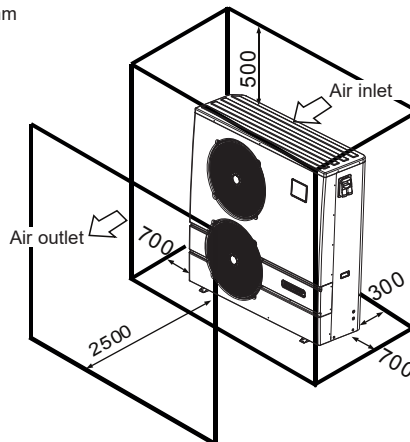

3. INSTALLATION AND CONNECTION (continued)



Do not position the device directly on the floor because this could cause problems.

Favour positioning on the ground on anti-vibration studs.

A wall bracket must not be used in conditions that can transmit vibrations.

Do not install the heat pump on a support that risks intensifying the unit's vibrations.

Do not install the heat pump anywhere liable to amplify its noise level or anywhere where its noise could disturb neighbours.

Do not use adhesives: the latter are not considered to be a reliable means of fastening.

Preferably, install the heat pump on a flat and dissociated cement block. Set up the unit on the supplied rubber bushing (fastenings and washers supplied).

Fasten the device, in compliance with the tightening indicated to avoid any risk of accident or damage to equipment and persons.

Another possibility: install the heat pump on rubber floor supports using suitable fastenings (not supplied).

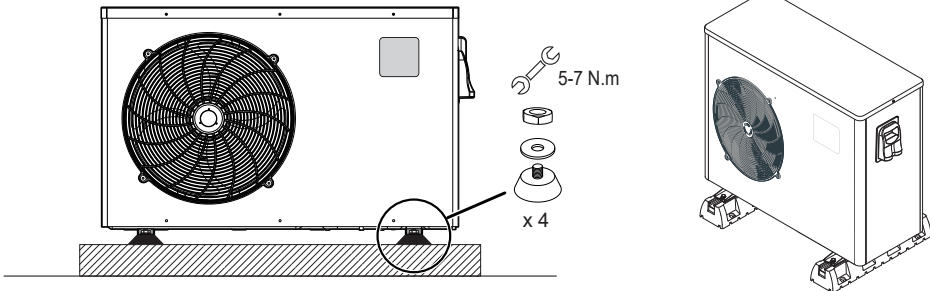

The maximum installation distance between the unit and the swimming pool is 15 metres.

The total length of the piping to and from the unit is 30 metres.

Insulate both the above ground and buried hydraulic piping.

The heat pump must be installed at a minimum distance from the pool in compliance with NF C 15-100 (3.5 m from the water for France) or in compliance with installation standards applicable in other countries.

Do not install the heat pump close to a heat source.

For installation in snowy regions we recommend sheltering the machine to avoid snow accumulating on the evaporator.

3. INSTALLATION AND CONNECTION (continued)

3.3 Hydraulic connection

The unit is supplied with two 50 mm Ø union connections. Connect the water inlet to the heat pump coming from the filtration group then connect the water outlet to the heat pump at the water conduit going to the pool (see diagram below).

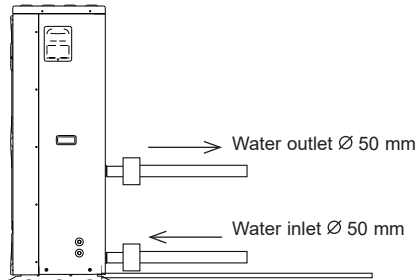

Install a by-pass valve between the heat pump entrance and exit.



If an automatic distributor or an electrolyser is used, it should be installed imperatively after the heat pump with the goal of protecting the titanium condenser against an elevated concentration of chemicals.



Be sure to install the by-pass valve and the supplied union connections at the water inlet and outlet level in order to simplify purging during the winter period and to facilitate access when disassembling for maintenance.

3. INSTALLATION AND CONNECTION (continued)

3.4 Electrical connection



Electrical installation and wiring for this equipment must be in conformity with local installation standards.

F	NF C15-100	GB	BS7671:1992
D	DIN VDE 0100-702	EW	EVHS-HD 384-7-702
A	ÖVE 8001-4-702	H	MSZ 2364-702/1994/MSZ 10-553 1/1990
E	UNE 20460-7-702 1993, RECBT ITC-BT-31 2002	M	MSA HD 384-7-702.S2
IRL	Wiring Rules + IS HD 384-7-702	PL	PN-IEC 60364-7-702:1999
I	CEI 64-8/7	CZ	CSN 33 2000 7-702
LUX	384-7.702 S2	SK	STN 33 2000-7-702
NL	NEN 1010-7-702	SLO	SIST HD 384-7-702.S2
P	RSIUEE	TR	TS IEC 60364-7-702



Verify that the available electrical power supply and the network frequency correspond to the required operating current taking into account the appliance's specific location, and the current required to supply any other appliance connected to the same circuit.

ENP10TAS 400 V \sim +/- 10 % 50 Hz 3 Phases **Check that the phases balance does not exceed 2%**

See the corresponding wiring diagram in the appendix. The connection box is located on the right side of the unit. Three connections are designed for the power supply and two are for controlling the filter pump (Enslavement).

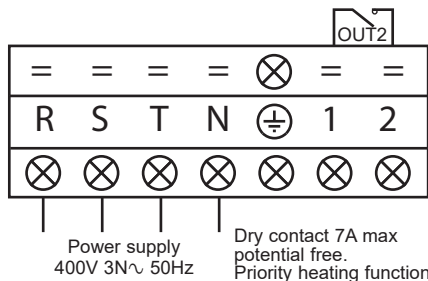

3. INSTALLATION AND CONNECTION (continued)



Never use an electrical plug for the power supply.

The electrical power supply must have, in a suitable manner, an omnipolar protection device of the D-curve circuit breaker type as well as a 30mA protection differential circuit breaker (see following table).

Model		ENP10TAS
Power supply	V/Ph/Hz	400V 3N~ 50Hz
aM type fuse calibre	A	20 aM
Curve D circuit breaker	A	20 D
Cable section	mm ²	5G4 5 x 4



Use an RO 2V/R 2V or equivalent power cord.



The cables sections are given for a maximum length of 25 m. They must however be checked and adjusted according to the installation conditions.



Always shut down the main power supply before opening the electrical control box.

3.5 Initial start-up

Start-up procedure - After installation is complete, follow these steps:

- 1) Rotate the fans by hand to verify that they can turn freely by hand, and that the turbine is correctly affixed to the motor shaft.
- 2) Ensure that the unit is connected correctly to the main power supply (see the wiring diagram in the appendix).
- 3) Activate the filtration pump.
- 4) Verify that all water valves are open and that the water flows toward the unit before switching on the heating or cooling mode.
- 5) Verify that the drainage hose is correctly affixed and that it causes no obstructions.
- 6) Activate the unit power supply, then press the On/Off button  on the control panel.
- 7) Ensure that no ALARM code is displayed when the unit is ON (see troubleshooting guide).

3. INSTALLATION AND CONNECTION (continued)

- 8) Set the water flow using the by-pass valve (see § 3.6 and 2.1), as provided for by each model, to obtain an Entry/Exit temperature of 2°C.
- 9) After running for several minutes, verify that the air exiting the unit is cool (between 5 and 10°).
- 10) With the unit operating, turn off the filter pump. The unit should automatically turn off and display error code E03.
- 11) Allow the unit and the pool pump to run 24 hours per day until the desired water temperature has been reached. When the set water inlet temperature is reached, the unit will turn off. It will automatically restart (as long as the pool pump is running) if the pool temperature is at least 0.5°C below the set temperature.

Water flow switch - The unit is equipped with a flow switch that turns on the heat pump when the pool filtration pump is running, and deactivates it when the filtration pump is out of order. If the water is low, the E03 alarm code will appear on the regulator (See § 6.4).

Time delay - The unit is equipped with a time delay of 3 minutes in order to protect the control circuit components, to eliminate restart cycling and contactor chatter. Thanks to this time delay, the unit automatically restarts approximately 3 minutes after each control circuit interruption. Even a brief power interruption will activate the restart time delay.

Phase switch - The Triphasic units include a phase switch to ensure that the compressor is rotating in the correct direction. If the unit does not start, check the condition of the phase switch located in the electrical box.

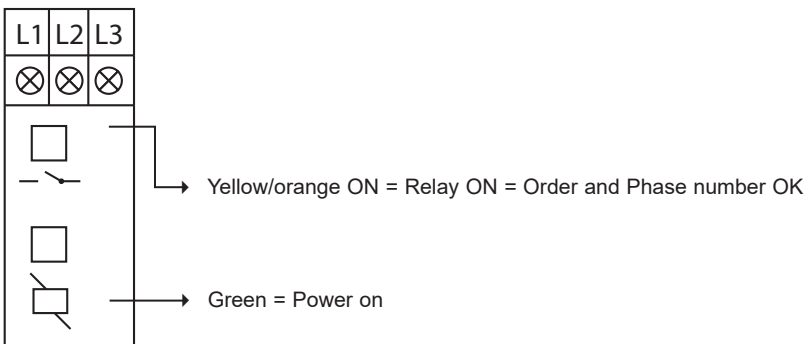

3. INSTALLATION AND CONNECTION (continued)

3.6 Water flow setting

With the water entry and exit valves being open, adjust the by-pass valve in order to obtain a difference of 2°C between the inflow and outflow temperature (see principle diagram § 3.1). You can verify the switch by seeing the entry/exit temperatures directly on the control panel.

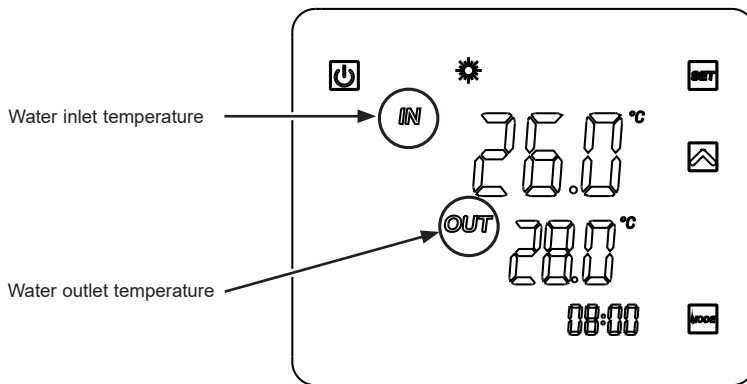

Note: Opening the by-pass valve creates a weaker flow, which leads to an increase in ΔT .

Closing the by-pass valve creates a stronger flow, which leads to a decrease in ΔT .

4. USER INTERFACE

4.1 General presentation

The heat pump is equipped with a digital control panel with a touch screen, electronically connected and pre-set at the factory in heating mode.

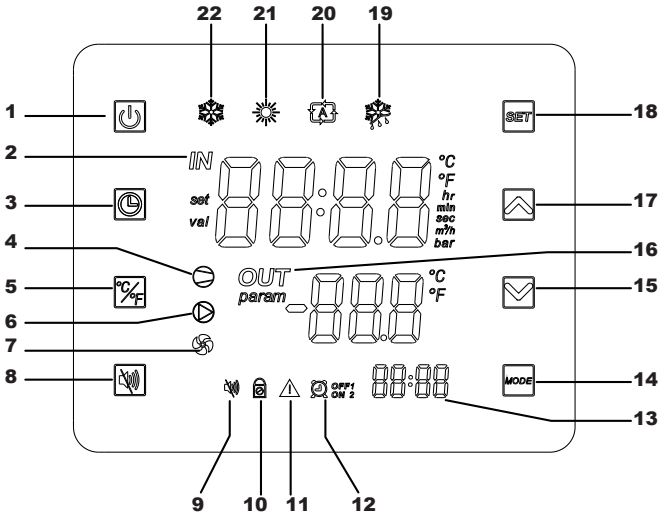

Legend

1		On/Off
2		Water inlet
3		Clock and timer settings
4		Compressor ON
5		Conversion °C/°F
6		Dry contact OUT2
7		Fan ON
8		Silent mode
9		Silent mode indicator
10		Locked screen
11		Alarm

12		Timers 1 and 2
13		Timers' time
14		Mode selection
15		Scroll down / Decrease
16		Water outlet
17		Scroll up / Increase
18		Save / settings
19		Defrost mode
20		Automatic mode
21		Heating mode
22		Cooling mode

4. USER INTERFACE (continued)

OFF Mode

When the heating pump is in sleep mode (OFF Mode) "OFF" is displayed on the command screen.

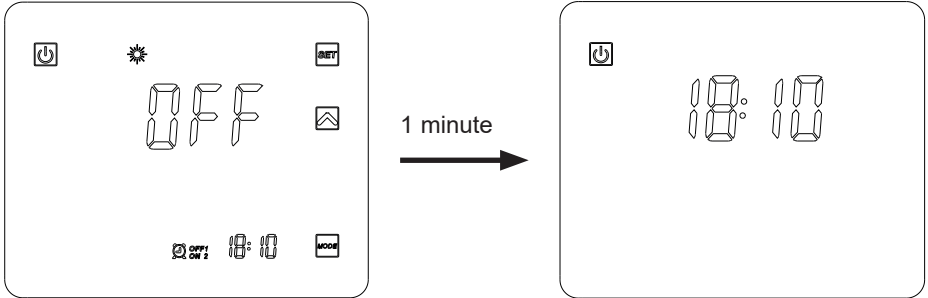

ON Mode

When the heating pump is running or regulating (ON Mode), the inlet and outlet water temperatures are displayed on the command screen.

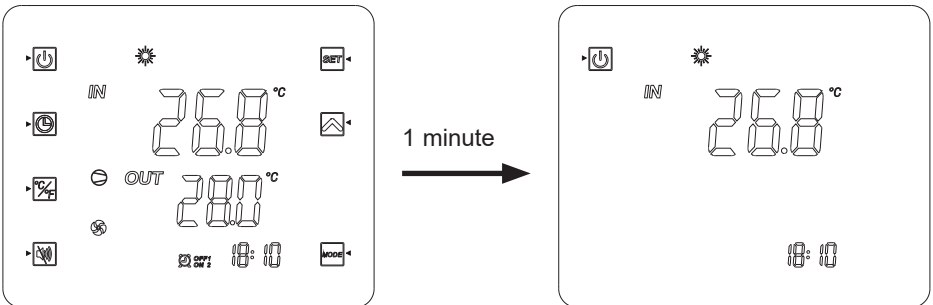











4. USER INTERFACE (continued)

At the end of a setting, press  to validate.

The settings will be automatically saved if no button is pressed during 20s.

4.2 Clock settings

If the display is in standby mode, press  briefly on .









- 1) Press  to bring up the symbol .
- 2) Press  to make the time display flash. Set the hour using the buttons  .
- 3) Press  then set the minutes with the buttons  .
- 4) Press  to validate.

4.3 Timer function settings











Setting this function is necessary if you would like to run the heat pump for a shorter period than what is defined by the filtration clock. Therefore, you can program a deferred start and an anticipated stop or simply stop a certain timeframe from running (at night, for example).

It is possible to set 2 Start Timers (ON1 et ON2) and 2 Stop Timers (OFF1 et OFF2).

Timer 1 setting – Start

- 1) Press  for 2s, Timer ON1  flashes (*).
- 2) Press  to set the hours with the buttons  .
- 3) Press  to set the minutes with the buttons  .
- 4) Press  to validate.

Timer 1 setting – Stop

- 1) Press  for 2s, Timer ON1  flashes (*).
Press  once, Timer OFF1  flashes.
- 2) Press  to set the hours with the buttons  .
- 3) Press  to set the minutes with the buttons  .
- 4) Press  to validate.

(*) To access Timer ON2  directly, press  for 2s, then press  twice.



4. USER INTERFACE (continued)

Timer 2 settings

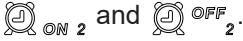















After the Timer 1 settings, you will access directly the settings for Timer 2:



Proceed in the same manner as for Timer 1.

Nota: To access directly Timer ON2 , press  for 2s, then press twice on .

Timers suppression (Start and Stop)

- 1) Press  for 2s, Timer ON1  flashes.(*)
 - 2) Press  to make the time display flash.
 - 3) Press  to suppress the Timer .
 - 4) Press  to validate.
 - 5) Press  for 2s, the Timer  flashes.
Press once , the Timer  flashes.(*)
 - 6) Press  to make the time display flash.
 - 7) Press  to suppress the Timer .
- (*) To access Timers 2  or , follow steps 1) or 4) then press twice . Proceed in the same manner as above.

4.4 Operation mode selection

In Mode “OFF” or “ON”

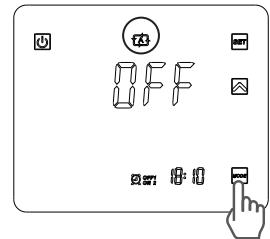
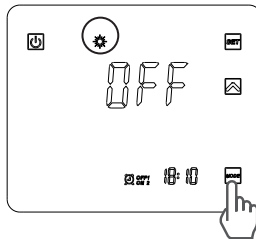
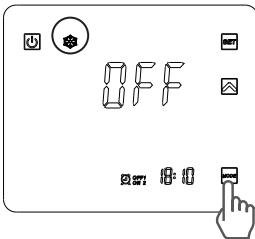

Press the button  to change mode: cooling, heating or automatic.



If the heat pump is set in heating only or cooling only, changing mode is not possible.



4. USER INTERFACE (continued)

4.5 Setting and visualisation of the set point (desired water temperature)

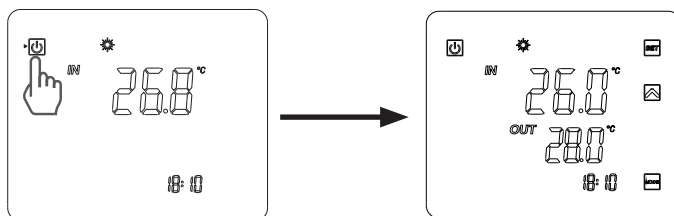
If the button  is not visible on the screen, press  briefly.
(While operating or stopped, simply press the button  to view the set point)



In Mode “OFF” or Mode “ON”



Press the button  to display the set point, then press  or  to set the set point you wish.



The setting is made with a precision of 0.5 °C.



It is recommended to never exceed 30°C to avoid alteration of the liners.

4.6 Locking and unlocking the touch screen

Press the button  for 5 s until it beeps and this symbol appears .

To unlock, press  for 5 s until it beeps and this symbol disappears .

4. USER INTERFACE (continued)

4.7 Silent function settings

This function allows the heat pump to be used at a fan rotation speed reduced to 600 rpm for a maximum of 8 hours, in order to limit noise problems during the night or day depending on the location of the heat pump in relation to neighbours and/or the pool.



This function can be Activated/Deactivated manually or using a Timer.

Manual activation

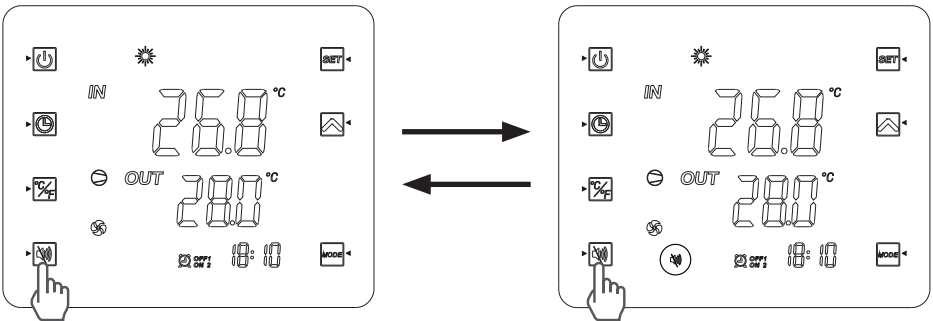
- 1) Press on .
- 2) The display below appears on the screen. The SILENT mode is activated for the next 8 hours.
- 3) The fans gradually reduce their rotation speed for a maximum duration of 8 h.
- 4) After operating for 8 h the function will automatically be deactivated and the fans will return to a rotation speed that varies according to the temperature of the outside air.



Manual deactivation

- 1) Press on .
- 2) The symbol  disappears from the screen: Silent mode is deactivated.
- 3) The fans adjust their rotation speed according to the outdoor air temperature.

4. USER INTERFACE (continued)



Programming the SILENT mode

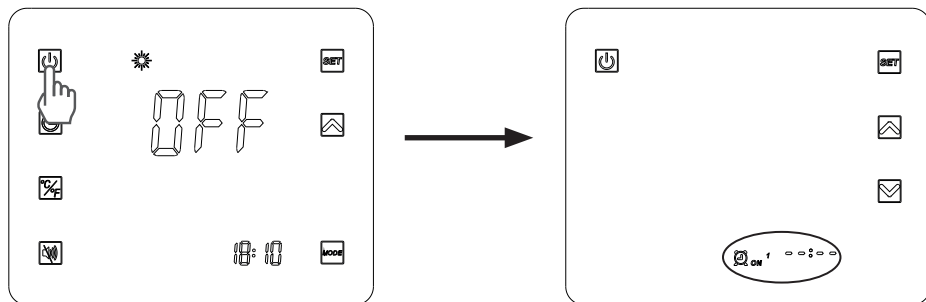

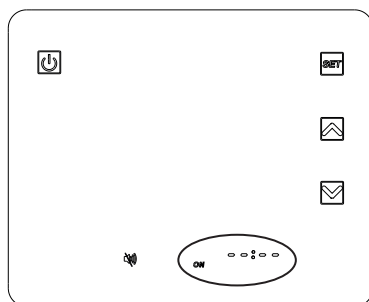

1) Press  for 2s : the Timer ON1  ON 1 flashes.



2) Press 4 times on  until the screen below is displayed.









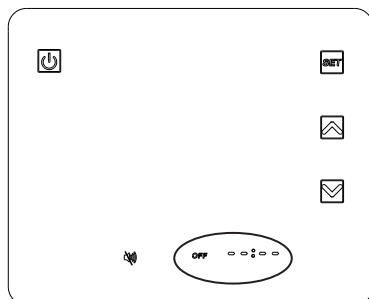

3) Press  to make the hour display flash. Use the arrows   to set the start time.

4) Press  to make the minutes display flash. Use the arrows   to set the start time. Press  to validate.

5) Press  to set the end time: the OFF sign will flash.



4. USER INTERFACE (continued)

- 6) Press  to make the hour display flash. Use the arrows   to set the end time.
- 7) Press  to make the minutes display flash. Use the arrows   to set the end time. Press  to validate.
- 8) Press  to return to the previous screen.
The **ON-OFF** signs are displayed as below.

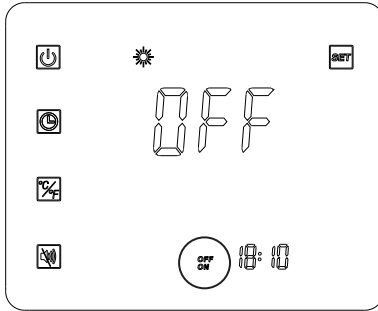

Nota : The minutes are set in 10-minute increments.

Once the SILENT mode has been set, it will be active by default 7 days a week.

5. MAINTENANCE AND WINTERISING

5.1 Maintenance

These maintenance operations must be carried out once per year in order to guarantee the longevity and the good working condition of the heat pump.

- The maintenance and repairs of the device must be carried out by an accredited professional in accordance with the regulatory texts and the rules of the art in effect in the country where the device is installed (see § 3.4).
For any intervention on the cooling circuit, the professional must hold a certificate of competence in handling refrigerants.
- Check the power cable. If the power cable is damaged, it has to be replaced by the manufacturer, its after-sales service or by a qualified and authorised person.
- Verify the grounding connection of the device and its continuity.
- Clean the coil with the help of a soft brush or jet of air or water (**Warning, never use a high pressure cleaner**).
- Verify that the drains flow well.
- Verify the tightening of the hydraulic and electrical connections
- Verify the hydraulic sealing of the condenser.
- Have the leak-tightness of the cooling circuit to the leak detector checked by an **accredited professional**.



Before any maintenance operation, the heating pump must be disconnected from any electrical current source. The maintenance operations must only be carried out by personnel that is qualified and authorised to handle liquid refrigerants.

5.2 Winterising

- Put the heat pump in “OFF” mode.
- Cut the power supply to the heat pump.
- Empty the condenser with the help of the drain to avoid any risk of deterioration (high risk of freezing).
- Close the by-pass valve and unscrew the entry/exit connection unions.
- Eliminate the maximum amount of residual stagnant water from the condenser with the help of an air gun.
- Close the water entry and exit areas of the heating pump to avoid introducing foreign bodies.
- Cover the heating pump with a dedicated winterising case.



Any damage caused by poor winterising maintenance will lead to cancellation of the warranty.

6. APPENDIX

6.1 Electrical diagram

ENP10TAS

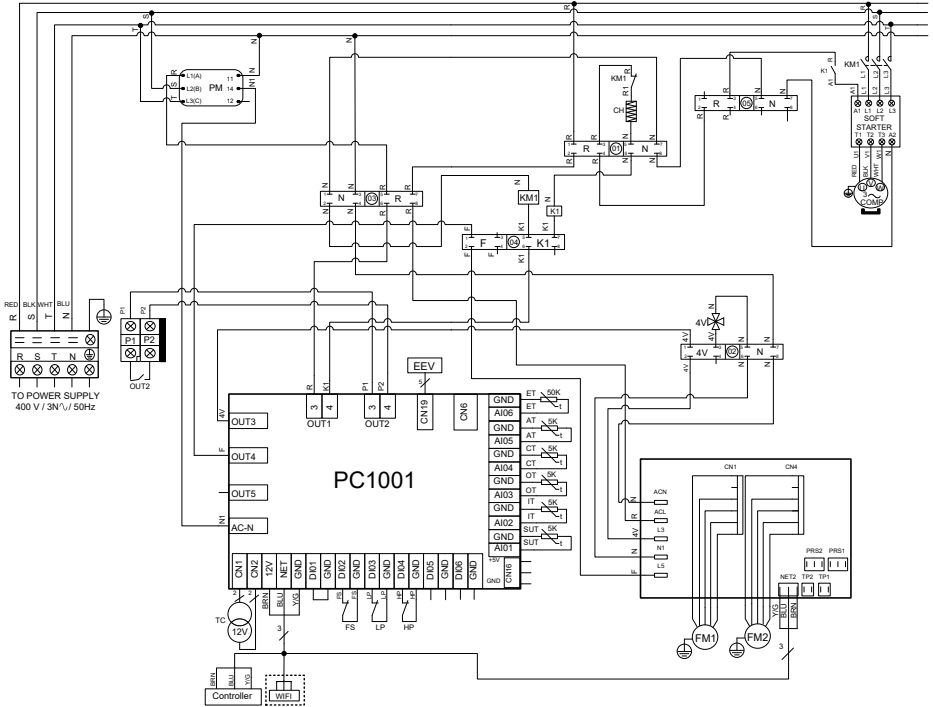

REMARKS:

- AT: AIR TEMPERATURE SENSOR
- COMP: COMPRESSOR
- CT: EVAPORATOR TEMPERATURE SENSOR
- EEV: ELECTRONIC EXPANSION VALVE
- FM1-2: FAN MOTOR
- FS: WATER PRESENCE DETECTOR
- HP: HIGH PRESSURE SWITCH
- IT: WATER INLET TEMPERATURE SENSOR
- LP: LOW PRESSURE SWITCH

- OT: OUTLET WATER TEMPERATURE SENSOR
- SUT: ASPIRATION TEMPERATURE SENSOR
- TC: TRANSFORMER 230V~ / 12V~
- 4V: 4 WAYS VALVE
- KM1: COMPRESSOR POWER CONTACTOR
- PM: PHASE SWITCH
- CH1: SUMP HEATER
- ET: DISCHARGE TEMPERATURE SENSOR
- OUT2: DRY CONTACT 7 A MAX
- : OPTION

6. APPENDIX (continued)

6.2 Heating priority wiring for three phases pump

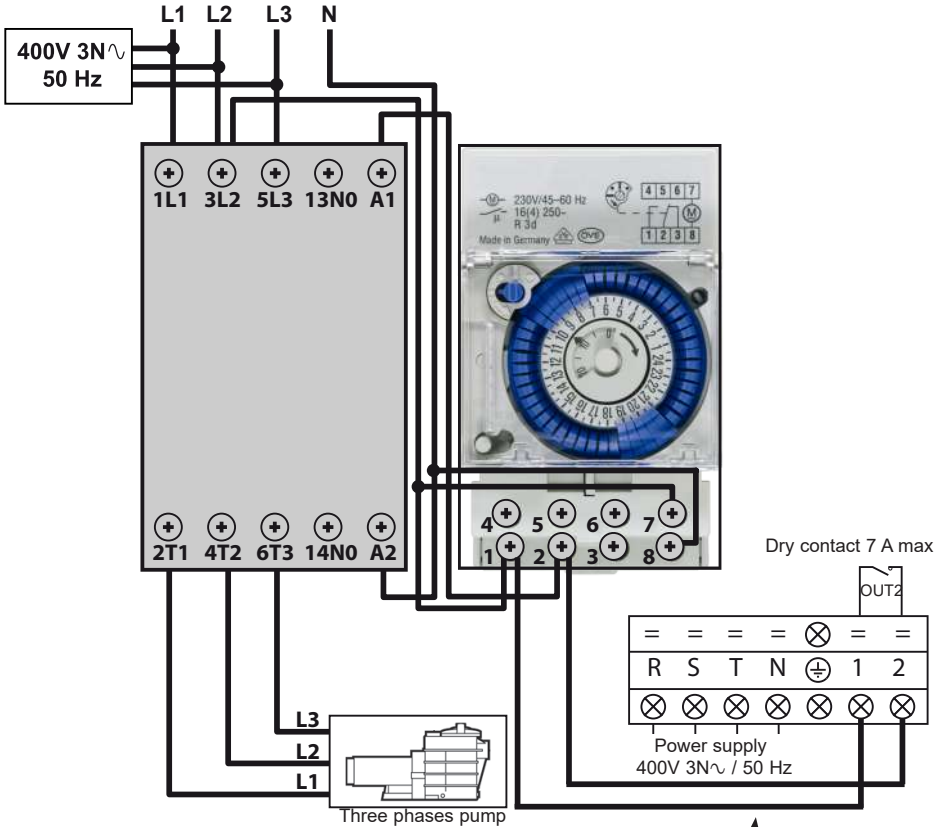

Terminals 1 and 2 deliver a potential-free dry contact, 230 V~ / 50 Hz, no polarity.

Wire terminals 1 and 2 as indicated in the diagram above, to activate the operation of the filtration pump in 2-minute cycles each hour if the temperature of the pool is lower than the set point.

 Never connect the power supply of the filtration pump directly to terminals 1 and 2.



Page left intentionally blank

6. APPENDIX (continued)

6.3 Exploded view and spare parts

ENP10TAS

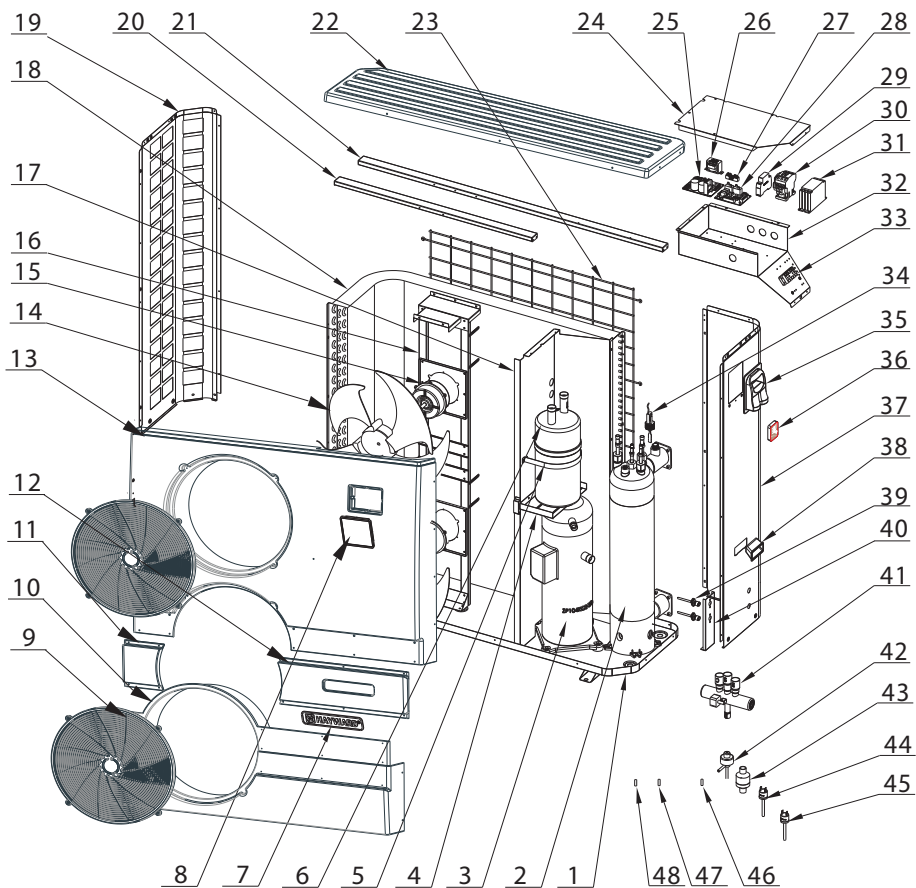

6. APPENDIX (continued)

ENP10TAS

Mark	Ref.	Description	Mark	Ref.	Description
1	HWX32005210049	Bottom panel	27	HWX20003909	2-point terminal block
2	HWX32005120009	Titanium/PVC condenser	28	HWX950531014516	PCB Board
3	HWX20000110153	Compressor	29	HWX200036023	Phase controller
4	HWX32027210011	Liquid tank support	30	HWX20000360209	Compressor switch Tri
5	HWX32027210013	Hose clamp	31	HWX20000360092	Smart Starter Tri
6	HWX35141402	Liquid tank	32	HWX32005210054	Electrical box
7	HWX20000230596	Hayward logo	33	HWX20000390180	Terminal block 5 connections Tri
8	HWX95005010018	LED Controller	34	HWX200036005	Flow switch
9	HWX32020220001	Fan protection grille	35	HWX32009220032	Access hatch
10	HWX32005220002	Lower front panel	36	HWX95005010014	WiFi module
11	HWX32005220005	Left decorative panel	37	HWX32005210060	Right panel
12	HWX32005220004	Right decorative panel	38	HWX32008220037	Handle
13	HWX32005220001	Upper front panel	39	HWX20000140353	HP&LP pressure gauge
14	HWX20000270025	Fan blade	40	HWX32019210038	HP/LP terminal support plate
15	HWX20000330361	DC Motor	41	HWX20011488	4 ways valve
16	HWX32005210058	Motor bracket	42	HWX20000140338	Electronic expansion valve
17	HWX32005210065	Centre wall	43	HWX20041455	Filter
18	HWX32005120008	Coil	44	HWX20003603	Low pressure switch
19	HWX32005210051	Left panel	45	HWX20013605	High pressure switch
20	HWX32005220055	Short stiffening plate	46/47	HWX20003242	Coil/air/water temp sensor
21	HWX32005210056	Large stiffening plate	48	HWX20003223	Compressor sensor 50 kΩ
22	HWX32005220003	Top cover	*49*	HWX20000240208	Wintering cover
23	HWX32005210063	Coil protection	*50*	HWX200026009	O Ring ID 48-Ep 5 mm
24	HWX32005210053	Electrical box cover	*51*	HWX200026061	O Ring ID 43-Ep 3,4 mm
25	HWX950531024107	Fan DC Inverter Module	*52*	HWX20003214	Crankcase heater
26	HWX200037003	230V~ - 12V~ transformer	*53*	HWX20002625	Silent bloc

Note: The *xx* markers are not indicated on the corresponding exploded view.

6. APPENDIX (continued)

6.4 Troubleshooting guide



Certain operations must be carried out by an authorized technician.

In case of a fault, the following signs are displayed on the screen:

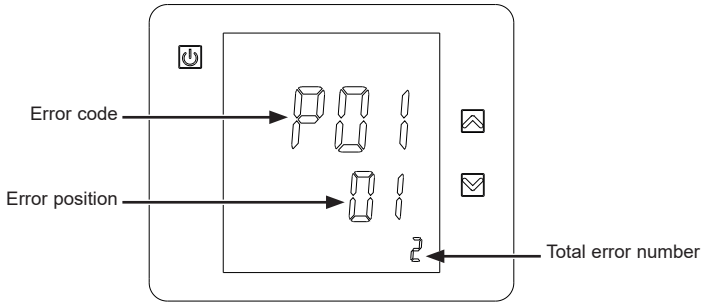

In the case of multiple errors, press on  or  to scroll through the error codes. Refer to following table.

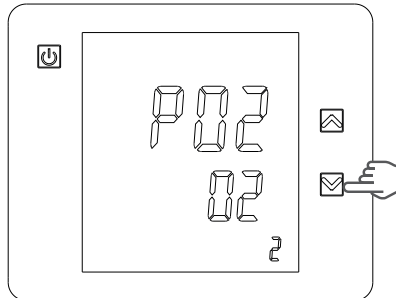

6. APPENDIX (continued)

Problem	Error codes	Description	Solution
Water inlet sensor defect.	P01	The sensor is open or presents a short-circuit.	Verify or replace the sensor.
Water outlet sensor defect.	P02	The sensor is open or presents a short-circuit.	Verify or replace the sensor.
De-icing sensor defect.	P05	The sensor is open or presents a short-circuit.	Verify or replace the sensor.
Exterior temperature sensor defect.	P04	The sensor is open or presents a short-circuit.	Verify or replace the sensor.
Compressor aspiration sensor defect	P07	The sensor is open or presents a short-circuit.	Verify or replace the sensor.
The inlet and outlet difference in water temperature is too high.	E06	Water flow volume is insufficient, water pressure difference is too low/ too high.	Verify the water flow, or system obstruction.
Antifreeze Protection Cold mode	E07	Water outlet quantity is too weak.	Verify the water flow, or the outlet water temperature sensor.
Level 1 antifreeze protection	E19	Air temperature or water inlet temperature is too weak.	
Level 2 antifreeze protection	E29	Air temperature or water inlet temperature is still too weak.	
High pressure protection	E01	Pressure of the refrigeration circuit is too high, or the water flow is too low, or the coil is obstructed or the air flow is too weak.	Verify the high pressure switch and the refrigeration circuit pressure. Verify the water or air flow. Verify that the flow switch is working correctly. Verify the water inlet/outlet valve openings. Verify the by-pass setting.
Low pressure protection	E02	Refrigeration circuit pressure is too weak, or air flow is too weak or the coil is obstructed.	Verify the low pressure switch and the refrigeration circuit pressure to determine if there is a leak. Clean the coil surface. Verify the fan rotation speed. Verify that there is free air flow to the coil.
Flow detector defect	E03	Water flow is insufficient or the detector is in short-circuit or defective.	Verify the water flow, verify the filtration pump and the flow detector to see if they have any possible problems.
Communication problem	E08	Problem with the LED controller or the PCB connection.	Check the connection of the NET and NET 1 cables.
The compressor will not start	E08	Phase missing or phase order incorrect	check that the 3 phases are present modify the phase order at the heat pump's electrical connection terminal block

6. APPENDIX (continued)

6.5 Warranty

WARRANTY CONDITIONS

All HAYWARD products are guaranteed to be free from manufacturing or material faults for a period of two years as from the date of purchase. Any claim made under the terms of the warranty must be accompanied by a dated proof of purchase. We therefore recommend that you keep your invoice.

The HAYWARD warranty is limited to the repair or replacement, at HAYWARD's discretion, of faulty products, provided they have been used under normal conditions, as described in their user guide, and that the product has not been modified in any way and has been used only with HAYWARD components and parts. Frost and chemical damage are not covered.

No other costs (transportation, labour, etc.) are covered by the warranty.

HAYWARD cannot be held liable for any direct or indirect damage caused by the incorrect installation, connection or operation of a product.

Please contact your retailer if you want to make a claim under the terms of the warranty and request the repair or replacement of an item. No equipment returned to our factory will be accepted without our prior written agreement.

Worn parts are not covered by the warranty.

6.6 End of life of the device



The symbol of the crossed-out dustbin concerning the treatment and the reclamation of electrical and electronic waste means that the products must not be disposed of with household waste, bulky items or in a landfill under no circumstances.

 At the end of life, the device must undergo selective collection so that it can be recycled or reclaimed. A specific circuit for recovering this type of products is set up in the countries of the European Union and in Norway.

Contact the installer or the local representative to have this device collected, dismantled and recycled.

Retreating the refrigerant, oil and other parts has to be carried out by a qualified accredited professional in accordance with current local and national legislation.

If the product contains batteries that bear this symbol, this means that the batteries can contain harmful or polluting substances. In this case, take the batteries to a used battery collection point.

ENERGYLINE PRO

UNIDAD DE BOMBA DE CALOR PARA PISCINAS



ENP10TAS

Manual de Instalación e Instrucciones

ÍNDICE

1. INSTRUCCIONES GENERALES - SEGURIDAD	1
2. CARACTERÍSTICAS TÉCNICAS	4
2.1 Datos técnicos de la bomba de calor	4
2.2 Margen de funcionamiento	5
2.3 Dimensiones	6
3. INSTALACIÓN Y CONEXIÓN	7
3.1 Esquema eléctrico	7
3.2 Bomba de calor	7
3.3 Conexión hidráulica	9
3.4 Conexión eléctrica	10
3.5 Primer arranque	11
3.6 Ajuste del caudal de agua	13
4. INTERFAZ USUARIO	14
4.1 Presentación general	14
4.2 Ajuste del reloj	16
4.3 Ajuste de la función Timer	16
4.4 Elección del modo de funcionamiento	17
4.5 Ajuste y visualización del punto de referencia	18
4.6 Apertura y bloqueo automático de la pantalla táctil	18
4.7 Ajuste del modo silencioso	19
5. MANTENIMIENTO E HIBERNACIÓN	22
5.1 Mantenimiento	22
5.2 Invierno	22
6. ANEXOS	23
6.1 Esquemas eléctricos	23
6.2 Conexiones con prioridad al calentador de bomba trifásico	24
6.3 Despiece y piezas de recambio	26
6.4 Guía de reparación	28
6.5 Garantía	30
6.6 Final de vida del aparato	30

Leer atentamente y conservar para consultar con posterioridad.

Este documento debe suministrarse al propietario de la piscina y debe ser conservado por éste en un lugar seguro.

1. INSTRUCCIONES GENERALES - SEGURIDAD

Le agradecemos que haya comprado esta bomba de calor para piscinas Hayward. Este producto se ha diseñado conforme a normas de fabricación estrictas para satisfacer los niveles de calidad más exigentes. Este manual incluye toda la información necesaria para la instalación, la resolución de fallos de funcionamiento y el mantenimiento. Lea este manual atentamente antes de abrir la unidad o realizar cualquier operación de mantenimiento en la misma. El fabricante de este producto declina toda responsabilidad en caso de lesiones del usuario o deterioro de la unidad debidos a posibles errores en la instalación, la resolución de fallos o el mantenimiento.

Es esencial seguir en todo momento las instrucciones detalladas en este manual. Una vez leído el manual, guárdelo en un lugar accesible para futuras consultas.

Personal habilitado

- La instalación, las conexiones eléctricas, el mantenimiento y las reparaciones del aparato deben ser efectuadas por un profesional calificado en conformidad con los textos reglamentarios y las reglas del arte vigentes en el país de instalación del aparato (cf § 3.4)
Para cualquier intervención en el circuito frigorífico, el profesional debe ser titular de un certificado de aptitud para la manipulación de fluidos frigorígenos.
Para Francia:
 - Instalación eléctrica de baja tensión según la NF-C 15-100.
 - Legislación sobre el manejo de fluidos frigorígenos Decreto 2007/737 y sus disposiciones de aplicación.

Condiciones de instalación

- No intente instalar por sí mismo este aparato.
- Este producto ha sido diseñado exclusivamente para su uso doméstico y su instalación en exterior. El aire que se escapa del producto debe poder fluir libremente, no debiendo ser empleado a otros fines, como el calentamiento o el enfriamiento de una estancia o un edificio.
- Esta bomba de calor calienta el agua de la piscina y mantiene una temperatura constante, no utilizarla para otros fines.
- Comprobar el cable de alimentación. Si el cable de alimentación está dañado, deberá ser sustituido por el fabricante, su servicio técnico o por una persona cualificada y autorizada.

1. INSTRUCCIONES - SEGURIDAD (continuación)

- La puesta a tierra y la unión del aparato son obligatorias. El hilo a tierra debe ser más largo que los otros hilos para prevenir riesgos de electrización en caso de arrancamiento del cable. La instalación eléctrica debe contar obligatoriamente con una protección diferencial de 30 mA (cf § 3.4).
- El no seguir cualquiera de estas recomendaciones supone la anulación de la garantía.

Consignas para la conservación y el mantenimiento

Las operaciones de mantenimiento deben realizarse 1 vez al año con el fin de garantizar la longevidad y el buen funcionamiento de la bomba de calor.

- El mantenimiento y las diferentes operaciones deben ser realizadas con la frecuencia y en los momentos recomendados que se especifican en el presente manual.
- Utilice solamente piezas de repuesto originales.
- Comprobar el cable de alimentación. Si el cable de alimentación está dañado, deberá ser sustituido por el fabricante, su servicio técnico o por una persona cualificada y autorizada.
- Verificar la conexión a tierra del aparato y su continuidad.
- Limpie el evaporador con un cepillo flexible o de un chorro de aire o agua (**Atención no utilizar jamás un limpiador de alta presión**).
- Verifique el buen flujo de los condensados.
- Compruebe la fijación de las conexiones hidráulicas y eléctricas
- Compruebe la estanqueidad hidráulica del condensador.
- **Un profesional autorizado** deberá comprobar la estanqueidad del circuito frigorífico con un detector de fugas.



Antes de realizar cualquier operación de mantenimiento, la bomba de calor debe estar desconectada de cualquier fuente de corriente eléctrica. Las operaciones de mantenimiento deben ser realizadas únicamente por personal cualificado y capacitado para manipular fluidos frigorígenos.

Consignas para el invierno

- Poner la bomba de calor en Modo "OFF".
- Cortar la alimentación de la bomba de calor.
- Vaciar el condensador a través del desagüe para evitar cualquier riesgo de degradación. (riesgo importante de congelación).
- Cerrar la válvula "by-pass" y desatornillar las conexiones de unión entrada/salida.

1. INSTRUCCIONES - SEGURIDAD (continuación)

- Expulse toda el agua estancada residual del condensador ayudándose con una pistola de aire.
- Obture la entrada y la salida de agua a la bomba de calor para evitar la intrusión de cuerpos extraños.
- Cubrir la bomba de calor con una funda de protección para el invierno.



Cualquier daño ocasionado por un mal mantenimiento invernal conlleva la anulación de la garantía.

Condiciones de uso

Este aparato puede ser utilizado por la infancia a partir de 8 años, así como por personas con capacidades físicas, sensoriales o mentales reducidas, o desprovistos de experiencia y conocimiento, si están correctamente vigiladas o si han recibido las instrucciones sobre el uso seguro del dispositivo y conocen los riesgos a los que se exponen. La infancia no debe jugar con el aparato. La limpieza y el mantenimiento por parte del usuario no deberán ser efectuados por la infancia sin vigilancia.

Este producto contiene gas refrigerante R410A

Este producto contiene gases de efecto invernadero enmarcados dentro del protocolo de Kyoto. No libere estos gases a la atmósfera.

Valor GWP(1) : 2088, Valor basado en el 4.º informe del GIEC.

La cantidad de refrigerante basada en el reglamento n.º 517/2014 (F-Gas) se indica en la placa de características de la unidad.

Cualquier intervención en el circuito frigorífico deberá ser efectuado por un profesional calificado, como indicado anteriormente.

Las inspecciones periódicas de fugas de refrigerante pueden ser requeridas por la legislación europea o local. Póngase en contacto con su distribuidor local para obtener más información.

- Cuidado, los fluidos frigorígenos pueden ser inodoros.
- No perforar ni calentar la tubería, pues existe un riesgo de explosión y de graves quemaduras.
- No emplear ningún medio de aceleración del proceso de deshielo o de limpieza distinto a los recomendados por el fabricante.
- El aparato debe almacenarse en un local libre de fuentes de inflamación que funcionen en continuo (por ejemplo, fuegos abiertos, aparatos de gas o radiador eléctrico en funcionamiento).

(1) Potencia global de calentamiento

2. CARACTERÍSTICAS TÉCNICAS

2.1 Datos técnicos de la bomba de calor



Modelo	ENERGYLINE PRO	ENP10TAS
Capacidad calorífica *	kW	36,9
Potencia eléctrica absorbida *	kW	6,87
Corriente de funcionamiento *	A	14,8
Tensión de alimentación	V / Ph / Hz	400 V / 3N~ / 50Hz
Calibre de fusible tipo aM	A	20
Disyuntor curva D	A	20
Número de compresores	/	1
Tipo de compresor	/	Scroll
Número de ventiladores	/	2
Potencia del ventilador	W	50 - 225
Velocidad de rotación de los ventiladores	RPM	600 - 1050
Ventilación	/	Horizontal
Nivel de presión acústica (a 10 m) LpA	dB(A)	41
Conexión hidráulica	mm	63
Caudal nominal de agua*	m ³ /h	13
Pérdida de carga sobre el agua (max)	kPa	13,8
Dimensiones netas de la unidad (L/a/a)	mm	1482 / 485 / 1480
Peso neto de la unidad	kg	182

* Rendimiento según la norma de ensayo NF EN 14511 retomada en el referencial NF-414.
Aire seco 15 °C - Humedad relativa 71 % - Temperatura de entrada del agua 26 °C.

2. CARACTERÍSTICAS TÉCNICAS (continuación)

2.2 Margen de funcionamiento

Utilizar la bomba de calor dentro de los siguientes márgenes de temperatura y de humedad para garantizar un funcionamiento seguro y eficaz.

	Modo calentamiento 	Modo enfriamiento 
Temperatura exterior	-12°C ~ +35°C	+7°C ~ +43°C
Temperatura del agua	+12°C ~ +40°C	+8°C ~ +40°C
Humedad relativa	< 80%	< 80%
Margen de reglaje del punto de referencia	+15°C ~ +32°C	+8°C ~ +32°C



Si la temperatura o la humedad no corresponden a estas condiciones, los dispositivos de seguridad pueden activarse y la bomba de calor puede no funcionar.



La temperatura máxima de calentamiento está limitada a 32°C para evitar el deterioro de los revestimientos. Hayward no se hace responsable en el caso de un uso por encima de +32°C.

2. CARACTERÍSTICAS TÉCNICAS (continuación)

2.3 Dimensiones

Modelo: ENP10TAS

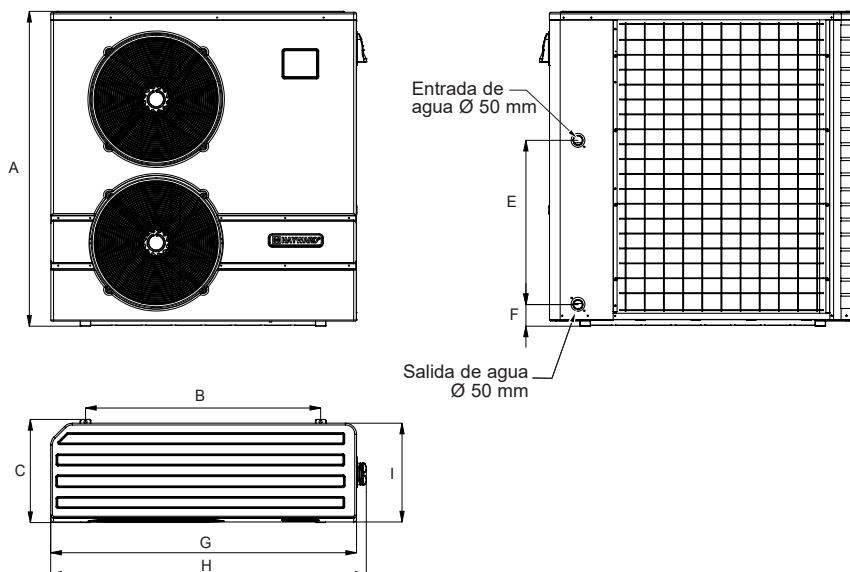

Unidad : mm

Modelo	ENP10TAS
Referencia	
A	1480
B	1105
C	485
D	/
E	771,5
F	101,5
G	1437
H	1483
I	464

3. INSTALACIÓN Y CONEXIÓN

3.1 Esquema eléctrico

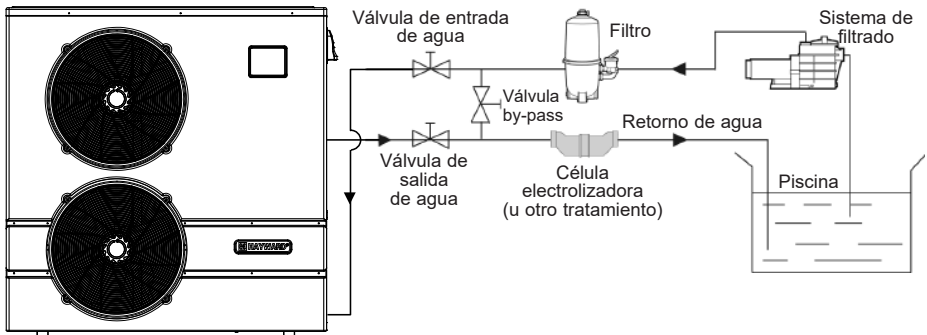

Nota: La bomba de calor se suministra sin ningún equipo de tratamiento o filtración. Los elementos que aparecen en el esquema son las piezas que deberá proporcionar el instalador.

3.2 Bomba de calor



Colocar la bomba de calor en el exterior y fuera de cualquier sala técnica cerrado.

Elegir una ubicación preferentemente soleada y protegida de los vientos dominantes.

El aparato debe ser perfectamente accesible para los trabajos de instalación y de mantenimiento ulteriores.

Colocar en una zona resguarda, las distancias mínimas que a continuación se prescriben deben ser respetadas a fin de evitar cualquier riesgo de recirculación del aire y de una degradación del rendimiento global de la bomba de calor.

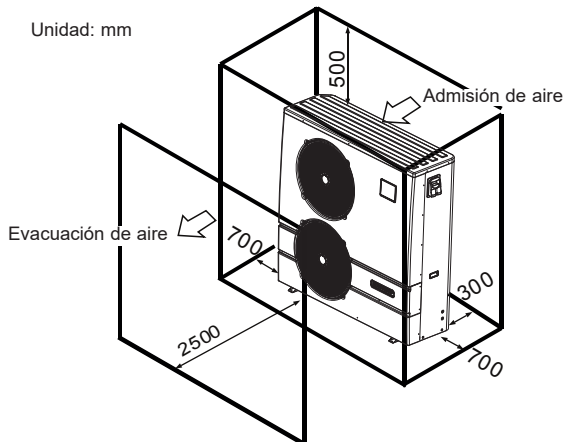

3. INSTALACIÓN Y CONEXIÓN (continuación)



No colocar el aparato directamente en el suelo pues podría provocar perturbaciones.

Deberá privilegiarse una colocación en el suelo sobre bloques antivibraciones.

No deberá emplearse un soporte mural en condiciones capaces de transmitir las vibraciones.

No instalar la bomba de calor sobre un soporte que pueda amplificar las vibraciones de la unidad.

No instalar la bomba de calor en un lugar que pueda amplificar su nivel sonoro o en un lugar donde el ruido de la unidad pueda molestar a los vecinos.

No emplear adhesivos: estos no son considerados medios de fijación fiables.

Preferiblemente instale la bomba de calor sobre una superficie de hormigón plana y aislada o una silla de fijación prevista a tal fin y monte la bomba de calor sobre los silentblocs suministrados (los tornillos y arandelas se suministran).

Fijar el aparato respetando el apriete indicado para evitar cualquier riesgo de accidente o daño a los materiales y las personas.

Otra posibilidad: instalar la bomba de calor sobre pies de caucho utilizando la tornillería adaptada (no suministrada).

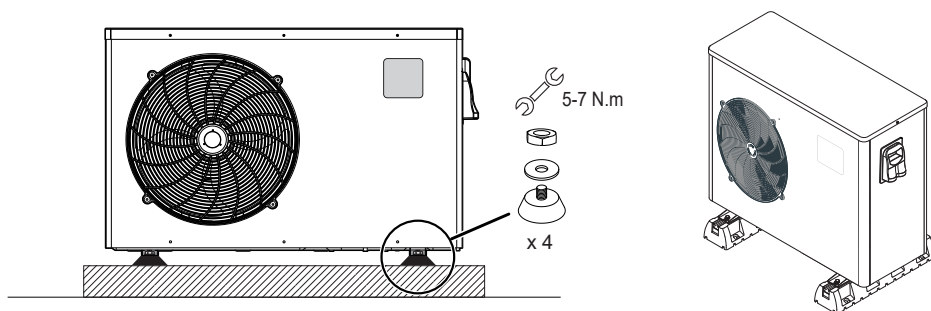

Distancia máxima de instalación entre la bomba de calor y la piscina 15 metros.

Longitud total de ida-vuelta de las canalizaciones hidráulicas 30 metros.

Aislar las canalizaciones hidráulicas de superficie y enterradas.

La bomba de calor debe instalarse a una distancia mínima de la piscina en cumplimiento de la NF C 15-100 (es decir a 3,5 m de la piscina para Francia) o según las normas de instalación vigentes en el resto de países.

No instalar la bomba de calor cerca de una fuente de calor.

En caso de instalación en regiones nevosas, se recomienda poner la máquina a resguardo para evitar una acumulación de nieve sobre el evaporador.

3. INSTALACIÓN Y CONEXIÓN (continuación)

3.3 Conexión hidráulica

La bomba de calor se suministra con dos conexiones de unión de 50 mm de diámetro. Utilice un tubo de PVC para la canalización hidráulica Ø 50 mm. Conecte la entrada de agua de la bomba de calor al conducto proveniente del grupo de filtración, tras esto conecte la salida de agua de la bomba de calor al conducto de agua que va a la piscina (cf esquema de abajo).

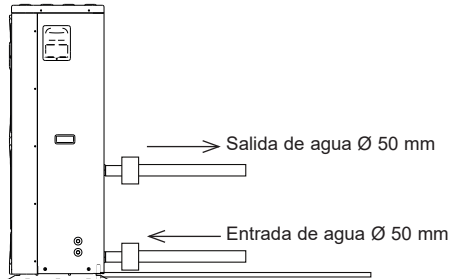

Instale una válvula "by-pass" entre la entrada y la salida de la bomba de calor.



Si se utiliza un distribuidor automático o un electrolizador, se debe instalar obligatoriamente después de la bomba de calor con el fin de proteger el condensador de titanio de una concentración demasiado grande de producto químico.



Se ruega instale la válvula by-pass y las conexiones de unión suministradas al nivel de la entrada y la salida de agua de la unidad, con el fin de simplificar la purga durante el periodo invernal y de facilitar el acceso o el desmontaje para el mantenimiento.

3. INSTALACIÓN Y CONEXIÓN (continuación)

3.4 Conexión eléctrica



La instalación eléctrica y el cableado de este equipo debe cumplir con la normativa de instalación local en vigor.

F	NF C15-100	GB	BS7671:1992
D	DIN VDE 0100-702	EW	EVHS-HD 384-7-702
A	ÖVE 8001-4-702	H	MSZ 2364-702/1994/MSZ 10-553 1/1990
E	UNE 20460-7-702 1993, RECBT ITC-BT-31 2002	M	MSA HD 384-7-702.S2
IRL	Wiring Rules + IS HD 384-7-702	PL	PN-IEC 60364-7-702:1999
I	CEI 64-8/7	CZ	CSN 33 2000 7-702
LUX	384-7.702 S2	SK	STN 33 2000-7-702
NL	NEN 1010-7-702	SLO	SIST HD 384-7-702.S2
P	RSIUEE	TR	TS IEC 60364-7-702



Compruebe que la alimentación eléctrica disponible y la frecuencia de la red corresponden con la corriente de funcionamiento requerida, teniendo en consideración el emplazamiento específico del aparato y la corriente necesaria para alimentar cualquier otro aparato que esté conectado al mismo circuito.

ENP10TAS 400 V \sim +/- 10 % 50 Hz 3 fases

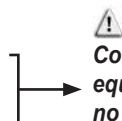

Compruebe que el equilibrio de las fases no supera el 2 %

Observe el esquema de cableado correspondiente en el anexo. La caja de conexiones se encuentra en el lado derecho de la unidad. Hay tres conexiones destinadas a la alimentación eléctrica y dos para el control del sistema de filtrado (servomecanismo).

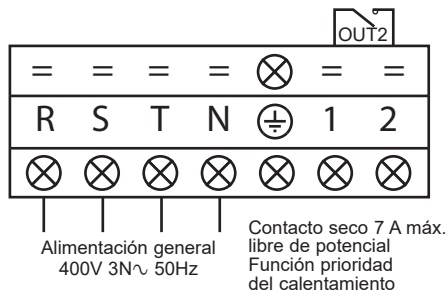

3. INSTALACIÓN Y CONEXIÓN (continuación)



No utilizar nunca una toma de corriente para la alimentación. La línea de alimentación eléctrica debe estar dotada, de manera apropiada, de un dispositivo de protección omnipolar de tipo disyuntor curva D, así como de un disyuntor diferencial de protección 30 mA (ver tabla a continuación).

Modelo		ENP10TAS
Alimentación eléctrica	V/Ph/Hz	400V 3N~ 50Hz
Calibre de fusible tipo aM	A	20 aM
Disyuntor curva D	A	20 D
Sección de cable	mm ²	5G4 5 x 4



Use un cable de alimentación de tipo RO2V/R2V o equivalente.



Las secciones de cable indicadas se corresponden a una longitud máxima de 25 m. Sin embargo, deben comprobarse y adaptarse en función de las condiciones de instalación.



Tenga siempre cuidado de detener la alimentación principal antes de abrir la caja de control eléctrico.

3.5 Primer arranque

Procedimiento de arranque - una vez que se ha terminado la instalación, siga y respete las siguientes etapas:

- 1) Gire los ventiladores con la mano para comprobar que pueden girar libremente y que la hélice está correctamente fijada al árbol del motor.
- 2) Asegúrese de que la unidad está conectada correctamente a la alimentación principal (ver el esquema de cableado en el anexo).
- 3) Active el sistema de filtrado.
- 4) Verifique que todas las válvulas de agua están abiertas y que el agua circula hacia la unidad antes de pasar al modo de calentamiento o enfriamiento.
- 5) Verifique que la acometida de purga de condensados está fijada correctamente y no presenta ninguna obstrucción.
- 6) Activar la alimentación eléctrica destinada a la unidad, después presione el botón de Marcha/Parada  sobre el panel de control.

3. INSTALACIÓN Y CONEXIÓN (continuación)

- 7) Asegúrese de que ningún código de ALARMA se activa cuando la unidad está en ON (ver guía de reparación).
- 8) Fije el caudal de agua con la ayuda de la válvula by-pass (ver § 3.6 y 2.1), tal y como se prevee respectivamente para cada modelo de manera que obtenga una diferencia de temperatura Entrada/ Salida de 2°C.
- 9) Tras estar funcionando unos cuantos minutos, verifique que el aire sale de la unidad y se enfría (entre 5 y 10°).
- 10) Estando la unidad en servicio, desactive el sistema de filtrado. La unidad debe pararse automáticamente y mostrar el código de error E03.
- 11) Haga funcionar la unidad y la bomba de la piscina durante 24 horas seguidas, hasta que se alcance la temperatura del agua deseada. Cuando la temperatura de entrada del agua alcance el valor de referencia, la unidad se para. Se pone en funcionamiento de nuevo automáticamente (siempre que la bomba de la piscina esté en servicio) si la temperatura desciende menos de 0,5°C por debajo de la temperatura de referencia.

Controlador del caudal - La unidad está dotada de un controlador de caudal que activa la bomba de calor mientras el sistema de filtrado de la piscina está en servicio y la desactiva cuando el sistema de filtrado está fuera de servicio. Por falta de agua, el código de alarma E03 aparece en el regulador (Ver § 6.4).

Temporización - la unidad integra una temporización de 3 minutos, que tiene por objeto proteger los componentes del circuito de control, eliminar cualquier inestabilidad en el arranque y cualquier interferencia del contactor. Por medio de esta temporización, la unidad arranca de nuevo automáticamente unos 3 minutos después de que se produzca un corte del circuito de control. Incluso un corte de corriente de corta duración activa la temporización de arranque.

Controlador de fase - Las unidades trifásicas integran un controlador de fase para garantizar que la rotación del compresor se realiza en el sentido correcto.

Si la unidad no arranca, compruebe el estado del controlador de fase situado en la caja eléctrica.

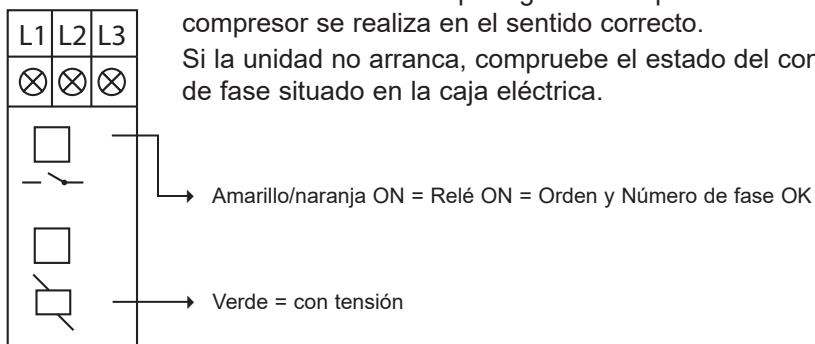

3. INSTALACIÓN Y CONEXIÓN (continuación)

3.6 Ajuste del caudal de agua

Con las válvulas de entrada y salida de agua abiertas, ajustar la válvula "by-pass" de forma que se obtenga una diferencia de 2°C entre la temperatura de entrada y de la salida del agua (ver el esquema eléctrico § 3.1). Puede verificar el ajuste visualizando las temperaturas de entrada/salida directamente sobre el panel de control.

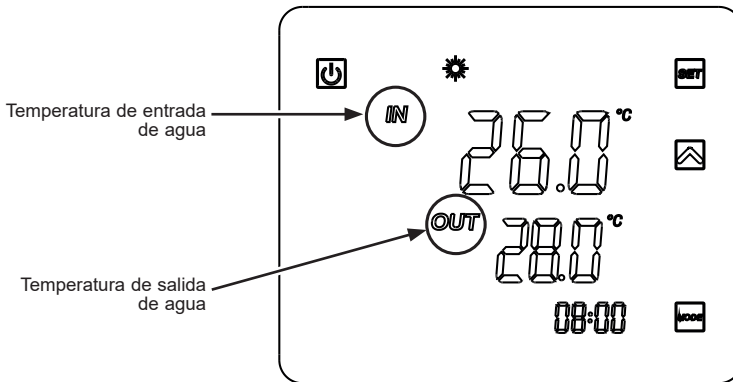

Nota: La apertura de la válvula "by-pass" genera un caudal menor, lo cual conlleva un aumento de ΔT .

El cierre de la válvula "by-pass" genera un caudal mayor, lo cual conlleva una disminución de ΔT .

4. INTERFAZ USUARIO

4.1 Presentación general

La bomba de calor está equipada con un panel de control digital con pantalla táctil, el cual ha sido previamente conectado eléctricamente y programado en fábrica para funcionar en modo calentamiento.

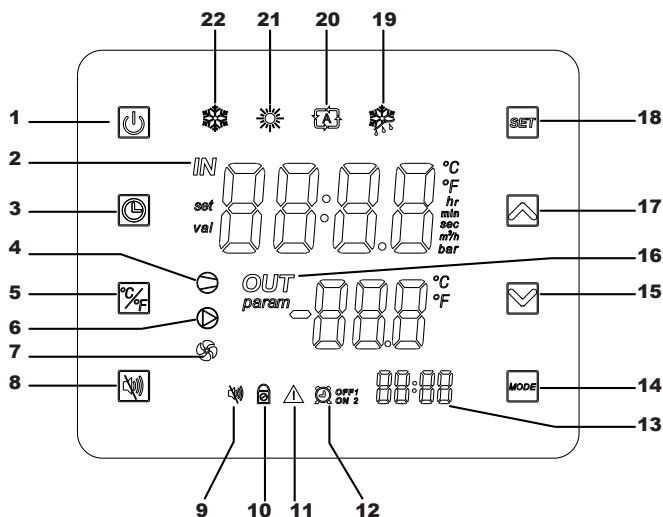

Leyenda

1		Marcha/ Parada	12		Timers 1 y 2 (temporizadores)
2		Entrada de agua	13		Hora de los Timers
3		Ajuste hora y Timers	14		Selección del modo
4		Compresor ON	15		Desfilado abajo / Reducir
5		Conversión °C/°F	16		Salida de agua
6		Contacto seco OUT2	17		Desfilado arriba / Aumentar
7		Ventilador ON	18		Validar / Ajustar
8		Modo silencioso	19		Modo deshielo
9		Testigo modo silencioso	20		Modo automático
10		Pantalla bloqueada	21		Modo calentamiento
11		Alarma	22		Modo enfriamiento

4. INTERFAZ USUARIO (continuación)

Modo OFF

Cuando la bomba de calor está en espera (Modo OFF) aparece "OFF" en la pantalla del regulador.

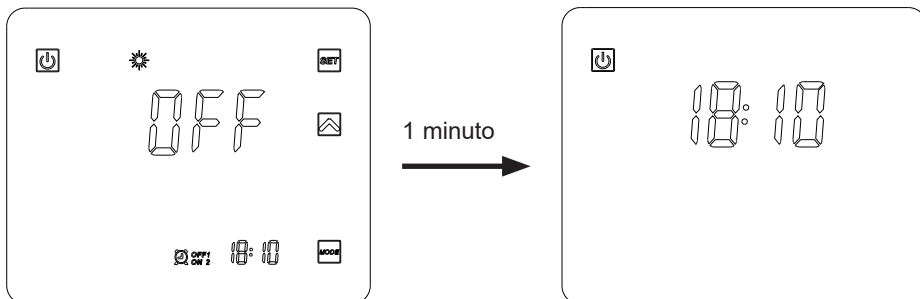

Modo ON

Cuando la bomba de calor está en funcionamiento o en regulación (Modo ON) las temperaturas de entrada y salida del agua aparecen en la pantalla del regulador.

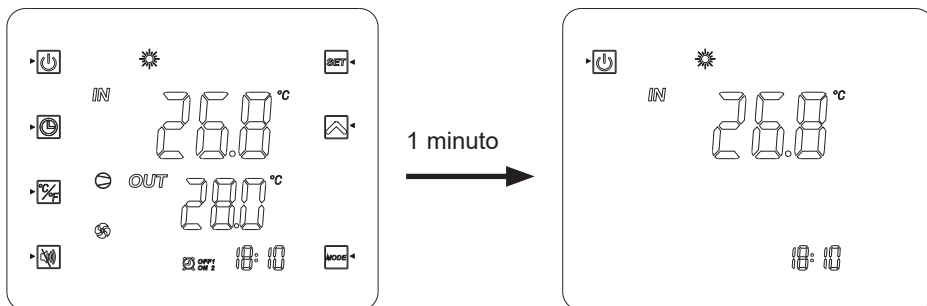









4. INTERFAZ USUARIO (continuación)

Al final de la configuración, presione  para validar.

El registro es automático si no se presiona ningún botón en 20 s.

4.2 Ajuste del reloj

Si el visualizador está en modo de espera, se debe pulsar brevemente .









- 1) Presione  para que aparezca el símbolo .
- 2) Presione , la visualización de la hora parpadea. Ajustar las horas con los botones  .
- 3) Presione  y después ajustar los minutos con los botones  .
- 4) Validar pulsando .

4.3 Ajuste de la función Timer











El ajuste de esta función será necesario cuando usted desee hacer funcionar su bomba de calor durante un periodo de tiempo más corto que el determinado por el reloj de filtración. De esta forma podrá programar un arranque retardado y una parada anticipada o simplemente prohibir un periodo horario de funcionamiento (por ejemplo la noche).



Tiene la posibilidad de programar 2 Timers de Marcha (ON1 y ON2) y 2 Timers de Parada (OFF1 y OFF2)..

Programación del Timer 1 – Marcha

- 1) Presione  durante 2 s, el Timer ON1  ¹ parpadea (*).
- 2) Presione  para ajustar las horas con los botones  .
- 3) Presione  para ajustar los minutos con los botones  .
- 4) Validar pulsando .

Programación del Timer 1 – Parada

- 1) Presione  durante 2 s, el Timer ON1  ¹ parpadea (*).
Presione 1 una vez , el Timer OFF1  ^{OFF1} parpadea.
- 2) Presione  para ajustar las horas con los botones  .
- 3) Presione  para ajustar los minutos con los botones  .
- 4) Validar pulsando .

(*) Para acceder directamente al Timer ON2 , pulsar  durante 2 s, y después pulsar 2 veces .



4. INTERFAZ USUARIO (continuación)

Programación del Timer 2

















Después de los ajustes del Timer 1, se accede directamente a los ajustes del

Timer 2:  y .

Proceder de la misma manera que para el Timer 1.

Nota: Para acceder directamente al Timer ON2 , pulsar  durante 2 s, y después pulsar 2 veces .

Supresión de los Timers (Marcha y Parada)

- 1) Presione  durante 2 s, el Timer ON1  parpadea.(*)
 - 2) Presione , la visualización de la hora parpadea.
 - 3) Presione  para cancelar el Timer .
 - 4) Presione  para confirmar.
 - 5) Presione  durante 2 s, el Timer ON1  parpadea.
Presione una vez , el Timer  parpadea.(*)
 - 6) Presione , la visualización de la hora parpadea.
 - 7) Presione  para cancelar el Timer .
- (*) Para acceder a los Timers 2  o , siga las etapas 1)- 4) y después pulse 2 veces . Proceder de la misma manera que anteriormente.

4.4 Elección del modo de funcionamiento

En Modo "OFF" o "ON"

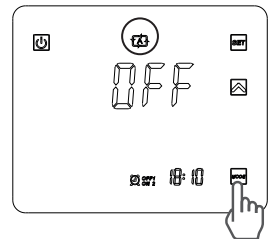
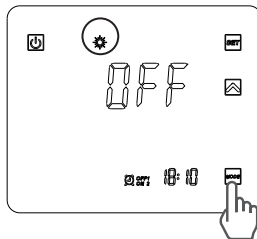
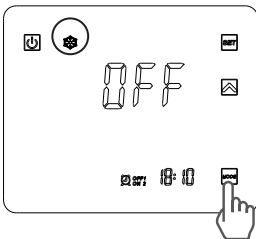

Presione el botón  para cambiar del modo : enfriamiento, calentamiento o automático.



Si la bomba de calor se encuentra en sólo calefacción o refrigeración sólo en el modo, el cambio de modo no es posible.



4. INTERFAZ USUARIO (continuación)

4.5 Ajuste y visualización del punto de referencia (Temperatura del agua deseada)

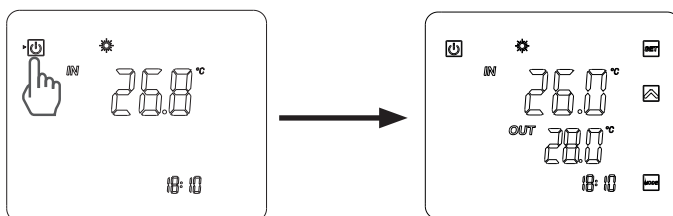
Si el botón  no está visible en la pantalla, se debe pulsar brevemente .
(En funcionamiento o en parada, basta con pulsar el botón  para visualizar el punto de consigna.)



En Modo “OFF” y Modo “ON”



Presione  para visualizar el punto de consigna, y después pulsar  o  para definir el punto de consigna deseado.



El ajuste se efectúa con una precisión de 0,5 °C.



Se recomienda no sobrepasar jamás la temperatura de 30°C para evitar la alteración de los liners.

4.6 Apertura y bloqueo automático de la pantalla táctil

Presione el botón  durante 5 s hasta que emita un bip y aparezca el símbolo .

Para el desbloqueo automático, presione  durante 5s hasta que emita un bip y desaparezca el símbolo .

4. INTERFAZ USUARIO (continuación)

4.7 Ajuste del modo silencioso

Esta función permite el uso de la bomba de calor con una velocidad de rotación de los ventiladores reducida a 600 rpm durante un tiempo de 8 horas como máximo, con el objetivo de limitar el ruido durante la noche o el día según la ubicación de la bomba de calor con relación al vecindario y/o la piscina.



Esta función se puede Activar / Desactivar manualmente o con un temporizador.

Activación manual

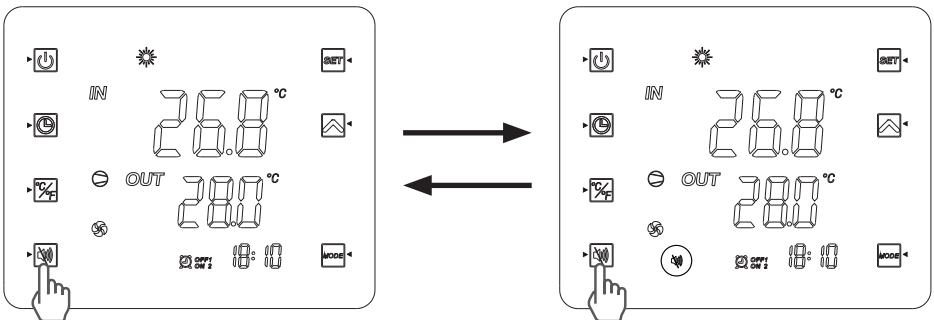
- 1) Pulsar el botón .
- 2) La visualización siguiente aparece en la pantalla, el modo Silencio se activa durante las siguientes 8 horas.
- 3) Los ventiladores reducen progresivamente su velocidad de rotación durante un tiempo máximo de 8 horas.
- 4) Tras 8 horas de funcionamiento, la función se desactivará automáticamente y la velocidad de rotación de los ventiladores dependerá de la temperatura del aire exterior.





Desactivación manual

- 1) Pulsar el botón .
- 2) El testigo  desaparece de la pantalla: el modo Silencio se desactiva.
- 3) Los ventiladores ajustan su velocidad de rotación en función de la temperatura del aire exterior.

4. INTERFAZ USUARIO (continuación)



Programación del modo SILENCIO

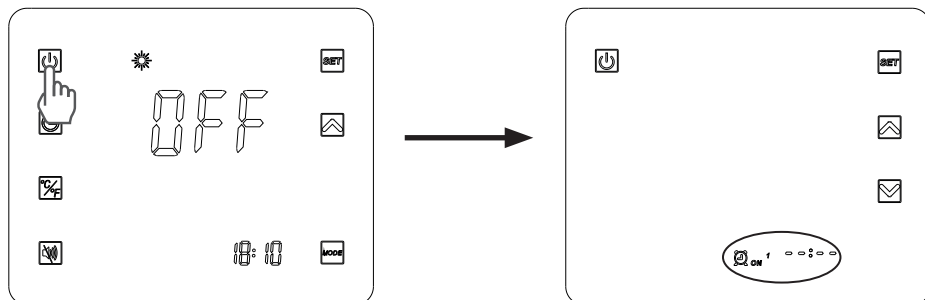

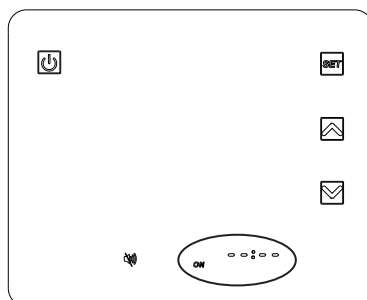

1) Presione  durante 2s : el Timer ON1  ON 1 parpadea.



2) Pulsar 4 veces  hasta la pantalla siguiente.









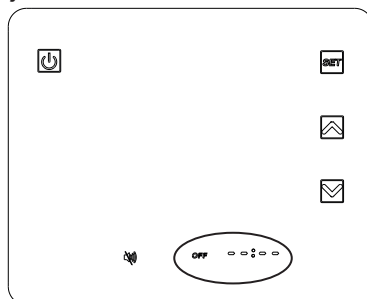

3) Presione , las horas parpadean. Usar las flechas   para ajustar la hora de inicio.

4) Presione , los minutos parpadean. Usar las flechas   para ajustar los minutos de inicio. Validar pulsando .

5) Presione  para ajustar la hora de fin: la indicación OFF parpadea.



4. INTERFAZ USUARIO (continuación)

- 6) Presione , las horas parpadean. Usar las flechas   para ajustar la hora de finalización.
- 7) Presione , los minutos parpadean. Usar las flechas   para ajustar los minutos de finalización. Validar pulsando .
- 8) Presione  para confirmar y volver a la pantalla anterior. Las indicaciones ON-OFF se visualizan como a continuación.

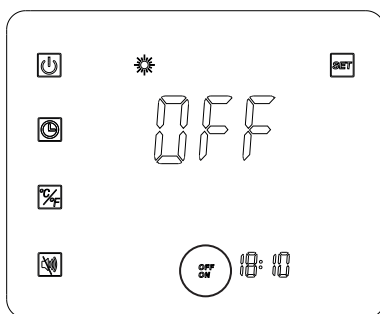

Nota : Los minutos se ajustan de 10 en 10.

Una vez finalizado el ajuste del modo SILENCIOSO, por defecto, permanece activo los 7 días de la semana.

5. MANTENIMIENTO E HIBERNACIÓN

5.1 Mantenimiento

Estas operaciones de mantenimiento deben realizarse 1 vez al año con el fin de garantizar la longevidad y el buen funcionamiento de la bomba de calor.

- El mantenimiento y las reparaciones del aparato deben ser efectuadas por un profesional calificado en conformidad con los textos reglamentarios y las reglas del arte vigentes en el país de instalación del aparato (cf § 3.4) Para cualquier intervención en el circuito frigorífico, el profesional debe ser titular de un certificado de aptitud para la manipulación de fluidos frigorígenos.
- Comprobar el cable de alimentación. Si el cable de alimentación está dañado, deberá ser sustituido por el fabricante, su servicio técnico o por una persona cualificada y autorizada.
- Verificar la conexión a tierra del aparato y su continuidad.
- Limpie el evaporador con un cepillo flexible o de un chorro de aire o agua (**Atención no utilizar jamás un limpiador de alta presión**).
- Verifique el buen flujo de los condensados.
- Compruebe la fijación de las conexiones hidráulicas y eléctricas
- Compruebe la estanqueidad hidráulica del condensador.
- **Un profesional autorizado** deberá comprobar la estanqueidad del circuito frigorífico con un detector de fugas.



Antes de realizar cualquier operación de mantenimiento, la bomba de calor debe estar desconectada de cualquier fuente de corriente eléctrica. Las operaciones de mantenimiento deben ser realizadas únicamente por personal cualificado y capacitado para manipular fluidos frigorígenos.

5.2 Invierno

- Poner la bomba de calor en Modo "OFF".
- Cortar la alimentación de la bomba de calor.
- Vaciar el condensador a través del desagüe para evitar cualquier riesgo de degradación. (riesgo importante de congelación).
- Cerrar la válvula "by-pass" y desatornillar las conexiones de unión entrada/salida.
- Expulse toda el agua estancada residual del condensador ayudándose con una pistola de aire.
- Obture la entrada y la salida de agua a la bomba de calor para evitar la intrusión de cuerpos extraños.
- Cubrir la bomba de calor con una funda de protección para el invierno.



Cualquier daño ocasionado por un mal mantenimiento invernal conlleva la anulación de la garantía.

6. ANEXOS

6.1 Esquemas eléctricos

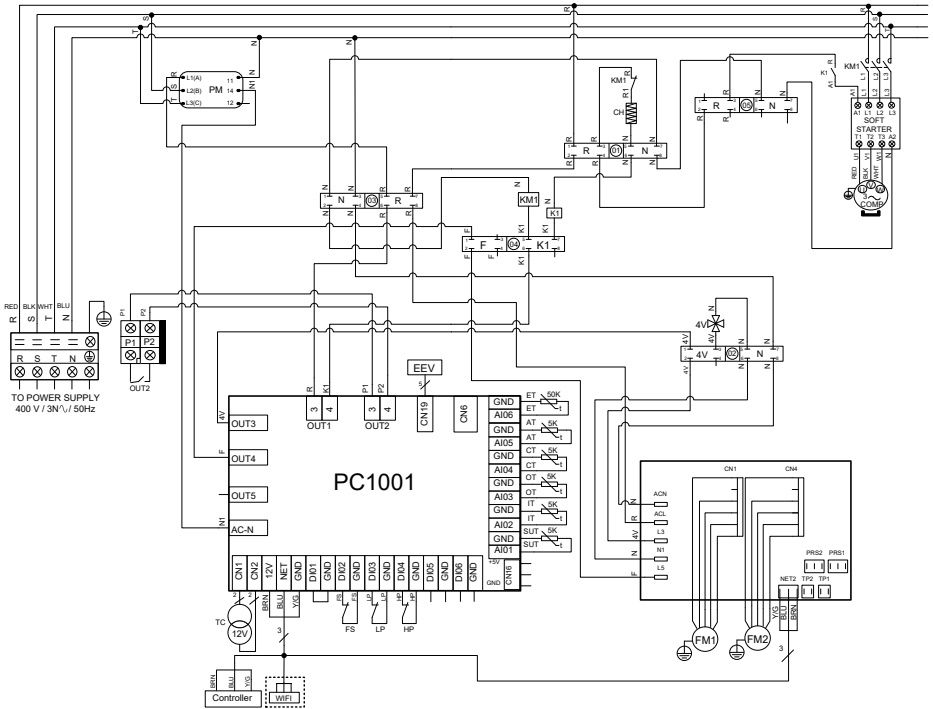

OBSERVACIONES:

- AT : SONDA DE TEMPERATURA DE AIRE
- COMP : COMPRESOR
- CT : SONDA DE TEMPERATURA EVAPORADOR
- EEV : DESCOMPRESOR ELECTRÓNICO
- FM1-2 : MOTOR VENTILADOR
- FS : DETECTOR DE PRESENCIA DE AGUA
- HP : PRESOSTATO ALTA PRESIÓN
- IT : SONDA DE TEMPERATURA DE ENTRADA DE AGUA
- LP : PRESOSTATO BAJA PRESIÓN

- OT : SONDA DE TEMPERATURA DE ENTRADA DE AGUA
- SUT : SONDA DE TEMPERATURA DE ASPIRACIÓN
- TC : TRANSFORMADOR 230V~/ 12V~
- 4V : VÁLVULA 4 VÍAS
- KM1 : CONTACTOR DE POTENCIA COMPRESOR
- PM : CONTROLADOR DE FASE
- CH1 : RESISTENCIA CARTER
- ET : SONDA DE TEMPERATURA DE DESCARGA
- OUT2 : CONTACTO SECO LIBRE DE 7 A MÁX. DE POTENCIAL
- : OPTION

6. ANEXOS (continuación)

6.2 Conexiones con prioridad al calentador de bomba trifásico

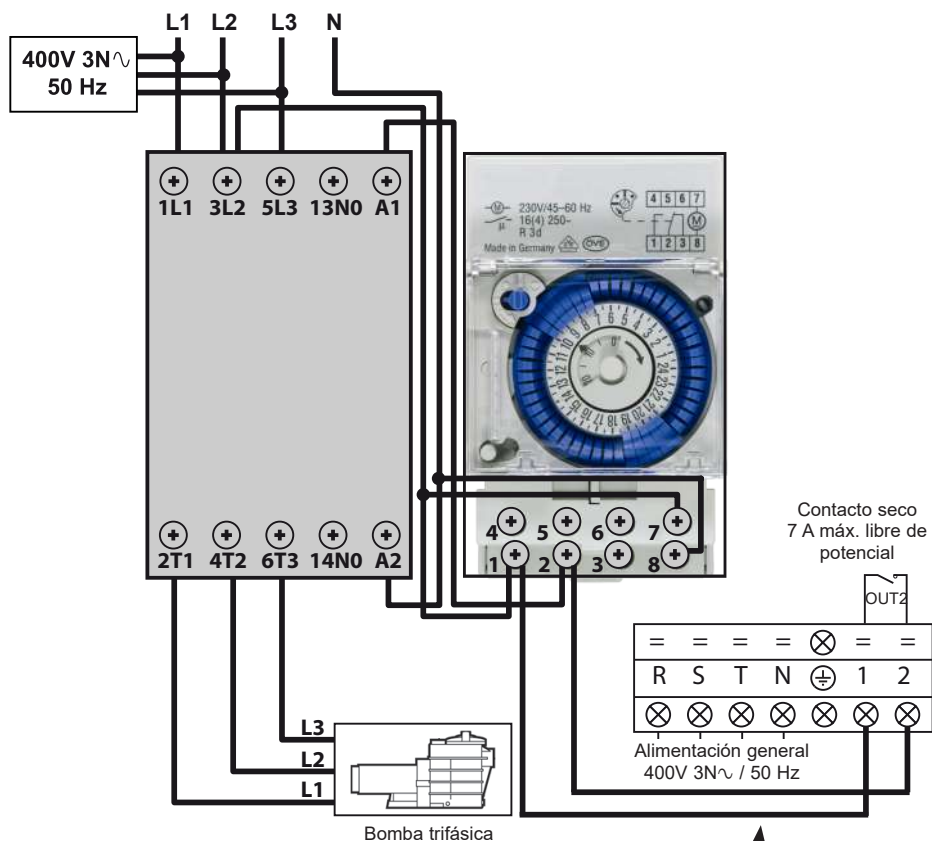

Los bornes 1 et 2 suministran un contacto seco (libre de potencial), sin polaridad de 230 V \sim / 50 Hz.

Conecte los cables a los bornes 1 y 2 respetando el esquema de cableado que se indica a continuación para que la bomba de filtración funcione por ciclos de 2 min cada hora en caso de que la temperatura de la piscina sea inferior al punto de consigna.

! No conecte nunca la alimentación de la bomba de filtración directamente a los bornes 1 y 2.



Página en blanco intencionalmente

6. ANEXOS (continuación)

6.3 Despiece y piezas de recambio

ENP10TAS

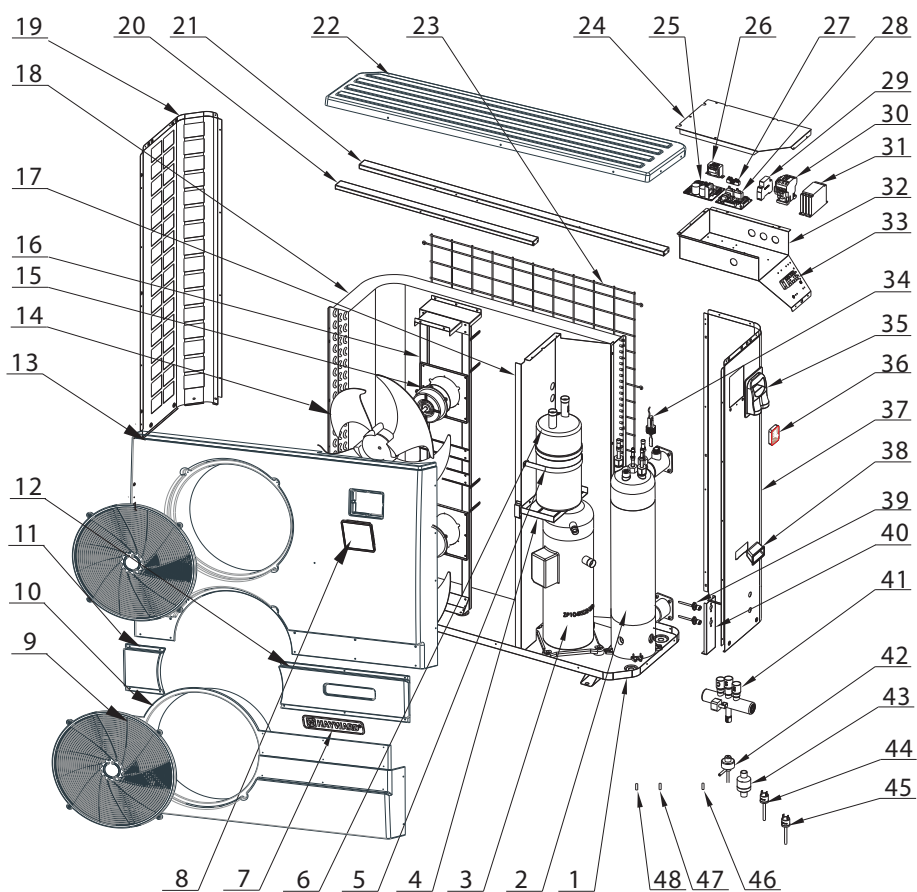

6. ANEXOS (continuación)

ENP10TAS

Rep	Ref.	Designación	Rep	Ref.	Designación
1	HWX32005210049	Fondo	27	HWX20003909	Regleta de terminales de 2 conexiones
2	HWX32005120009	Condensador de titanio/ PVC	28	HWX950531014516	Tarjeta electrónica
3	HWX20000110153	Compresor	29	HWX200036023	Controlador de fase
4	HWX32027210011	Soporte depósito líquido	30	HWX20000360209	Contactador del compresor Tri
5	HWX32027210013	Abrazadera de apriete	31	HWX20000360092	Arrancador electrónico tri
6	HWX35141402	Depósito de líquido	32	HWX32005210054	Caja eléctrica
7	HWX20000230596	Logo Hayward	33	HWX20000390180	Borna de 5 conexiones tri
8	HWX95005010018	Regulador LED	34	HWX200036005	Detector del caudal de agua
9	HWX32020220001	Rejilla de protección del ventilador	35	HWX32009220032	Trampilla de acceso eléctrico
10	HWX32005220002	Panel delantero inferior	36	HWX95005010014	Módulo WiFi
11	HWX32005220005	Panel decorativo izquierdo	37	HWX32005210060	Panel derecho
12	HWX32005220004	Panel decorativo derecho	38	HWX32008220037	Mango
13	HWX32005220001	Panel delantero superior	39	HWX20000140353	Toma de presión AP&BP
14	HWX20000270025	Hélice ventilador	40	HWX32019210038	Placa soporte tomas AP/BP
15	HWX20000330361	Motor de CC	41	HWX20011488	Válvula 4 vías
16	HWX32005210058	Soporte del motor	42	HWX20000140338	Descompresor electrónico
17	HWX32005210065	Panel de separación	43	HWX20041455	Filtro
18	HWX32005120008	Evaporador	44	HWX20003603	Presostato baja presión
19	HWX32005210051	Panel de la izquierda	45	HWX20013605	Presostato de alta presión
20	HWX32005220055	Rigidizador corto	46/47	HWX20003242	Sonda de temperatura evaporador/aire/agua
21	HWX32005210056	Rigidizador largo	48	HWX20003223	Sonda compresor 50 kΩ
22	HWX32005220003	Panel superior	*49*	HWX20000240208	Cubierta de protección
23	HWX32005210063	Protección evaporador	*50*	HWX200026009	Junta tórica ID 48-Ep 5 mm
24	HWX32005210053	Panel de protección eléctrica	*51*	HWX200026061	Junta tórica ID 43-Ep 3,4 mm
25	HWX950531024107	Módulo convertidor de CC	*52*	HWX20003214	Resistencia del cárter
26	HWX200037003	Transformador 230V _~ - 12V _~	*53*	HWX20002625	Silentblock

Nota: Las marcas *xx* no están referenciadas en la vista detallada correspondiente.

6. ANEXOS (continuación)



6.4 Guía de reparación

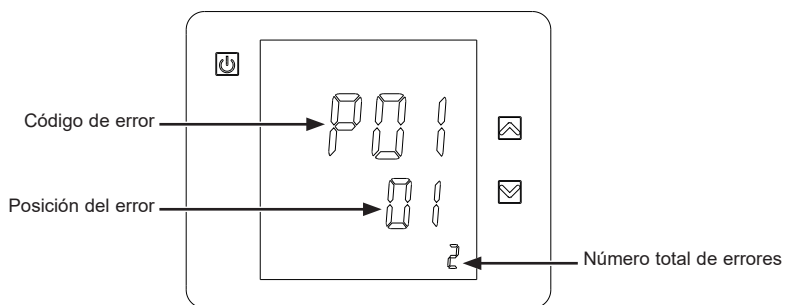

Algunas operaciones deben ser realizadas por un técnico habilitado..

En caso de fallo, las indicaciones siguientes aparecen en la pantalla:



En caso de errores múltiples, pulse  o  para hacer desfilar los códigos de error. Consulte la tabla siguiente.

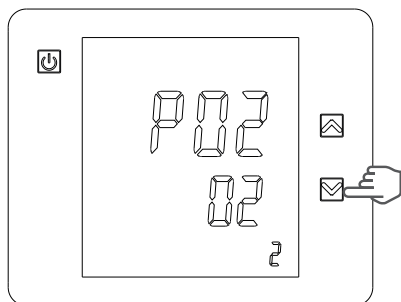

6. ANEXOS (continuación)

Fallo	Códigos de error	Descripción	Solución
Fallo de la sonda de entrada de agua	P01	El sensor está abierto o presenta un cortocircuito.	Comprobar o reemplazar el sensor.
Fallo de la sonda de salida de agua	P02	El sensor está abierto o presenta un cortocircuito.	Comprobar o reemplazar el sensor.
Fallo de la sonda de descongelación	P05	El sensor está abierto o presenta un cortocircuito.	Comprobar o reemplazar el sensor.
Fallo de la sonda de temperatura exterior	P04	El sensor está abierto o presenta un cortocircuito.	Comprobar o reemplazar el sensor.
Fallo de la sonda de aspiración del compresor	P07	El sensor está abierto o presenta un cortocircuito.	Comprobar o reemplazar el sensor.
Diferencia de temperatura demasiado grande entre el agua de salida y el agua de entrada	E06	Caudal de agua con un volumen insuficiente, diferencia de presión de agua demasiado débil/ demasiado elevada.	Comprobar el caudal de agua o la obstrucción del sistema.
Protección anticongelante Modo frío	E07	Cantidad de agua saliente demasiado débil.	Comprobar el caudal de agua o el sensor de temperatura de agua saliente.
Protección anticongelante de nivel 1	E19	Temperatura ambiente o del agua entrante demasiado débil.	
Protección anticongelante de nivel 2	E29	Temperatura ambiente o del agua entrante todavía más débil.	
Protección alta presión	E01	Presión del circuito frigorífico demasiado elevada, o el caudal de agua es demasiado débil, o el evaporador está obstruido, o el caudal de aire es demasiado débil.	Comprobar el presostato de alta presión y la presión del circuito frigorífico. Comprobar el caudal de agua o de aire. Comprobar el buen funcionamiento del controlador de caudal. Comprobar la apertura de las válvulas de entrada/salida de agua. Comprobar el ajuste del by-pass.
Protección baja presión	E02	Presión del circuito frigorífico demasiado débil, o el caudal de aire es demasiado débil o el evaporador está obstruido.	Comprobar el presostato de baja presión y la presión del circuito frigorífico para valorar si existe una fuga. Limpiar la superficie del evaporador. Comprobar la velocidad de rotación del ventilador. Comprobar la libre circulación del aire a través del evaporador.
Fallo del detector de caudal	E03	Caudal de agua insuficiente o detector en cortocircuito o defectuoso.	Comprobar el caudal de agua, el sistema de filtrado y el detector de caudal para ver si presentan otros fallos.
Problema de comunicación	E08	Fallo del controlador LED o de la conexión PCB.	Compruebe la conexión de los cables NET y NET 1.
El compresor no arranca	E08	Falta una fase u orden de las fases incorrectos	Compruebe la presencia de las 3 fases modifique el orden de las fases en la caja de bornes de la conexión eléctrica de la bomba de calor

6. ANEXOS (continuación)

6.5 Garantía

CONDICIONES DE GARANTÍA

Todos los productos HAYWARD están garantizados contra defectos de fabricación y material durante dos años a partir de la fecha de compra. Toda reclamación de garantía debe ir acompañada de una prueba de compra que justifique la fecha. A tal efecto, asegúrese de conservar su factura.

La garantía de HAYWARD se limita a la reparación o sustitución, a elección de HAYWARD, de los productos defectuosos, siempre que se hayan usado en condiciones normales, conforme a las recomendaciones e instrucciones del manual de uso, que no hayan sido objeto de modificación alguna y se hayan utilizado únicamente con componentes y piezas de HAYWARD. Los daños provocados por congelación y agentes químicos no están cubiertos por la garantía.

Todos los demás gastos (transporte, mano de obra, etc.) quedan excluidos de la garantía.

HAYWARD declina toda responsabilidad derivada de daños directos o indirectos causados por una instalación, una conexión o un uso incorrecto del producto.

Para usar la garantía y solicitar la reparación o sustitución de un artículo, póngase en contacto con su distribuidor. No se aceptarán envíos de material a nuestra fábrica sin nuestra aceptación previa por escrito.

Las piezas de desgaste no están cubiertas por la garantía.

6.6 Final de vida del aparato



El símbolo del contenedor tachado relativo al tratamiento y la revalorización de los residuos eléctricos y electrónicos significa que, en ningún caso, estos productos deberán ser desechados en la basura doméstica, con los residuos voluminosos ni en un vertedero.

Al final de su vida, el aparato deberá ser objeto de una recogida selectiva con vistas a su reciclaje o revalorización. En los países de la Unión Europea y en Noruega se ha implementado un circuito específico de recuperación para este tipo de productos.

Contactar con el instalador o el representante local para proceder a la recogida, el desmantelamiento y el reciclaje de este aparato.

El procesamiento de residuos del líquido refrigerante, del aceite y de otras piezas deberá ser efectuado por un profesional cualificado y calificado en conformidad con las legislaciones locales y nacionales vigentes.

Si el producto contiene pilas que portan este símbolo, esto significa que las pilas pueden contener sustancias nocivas o contaminantes. En este caso, deposite las pilas en un punto de recogida de pilas usadas.

ENERGYLINE PRO

BOMBA DE AQUECIMENTO PARA PISCINAS



ENP10TAS

Manual de instalação e de instruções

RESUMO

1. INSTRUÇÕES GERAIS - SEGURANÇA	1
2. CARACTERÍSTICAS TÉCNICAS	4
2.1 Dados técnicos da bomba de aquecimento	4
2.2 Período de funcionamento	5
2.3 Dimensões	6
3. INSTALAÇÃO E LIGAÇÃO	7
3.1 Esquema de princípio	7
3.2 Bomba de aquecimento	7
3.3 Ligação hidráulica	9
3.4 Ligação eléctrica	10
3.5 Primeira colocação em serviço	11
3.6 Ajuste do débito de água	13
4. INTERFACE DO UTILIZADOR	14
4.1 Apresentação geral	14
4.2 Ajuste do relógio	16
4.3 Ajuste da função Timer (temporizador)	16
4.4 Escolha do modo de funcionamento	17
4.5 Ajuste e visualização do ponto de ajuste	18
4.6 Bloqueio e libertação do ecrã táctil	18
4.7 Ajustamento do modo silêncio	19
5. MANUTENÇÃO E PREPARAÇÃO PARA O INVERNO	22
5.1 Manutenção	22
5.2 Preparação para o Inverno	22
6. ANEXOS	23
6.1 Esquema eléctrico	23
6.2 Ligações prioridade aquecimento bomba trifásica	24
6.3 Vistas explodidas e peças sobressalentes	26
6.4 Guia de resolução de avarias	28
6.5 Garantia	30
6.6 Fim de vida do aparelho	30

Ler atentamente e conservar para consulta posterior.

Este documento deve ser entregue ao proprietário da piscina e deve ser conservado por este em local seguro.

1. INSTRUÇÕES GERAIS - SEGURANÇA

Estamos gratos por ter adquirido esta bomba de aquecimento para piscina da Hayward.

Este produto foi concebido segundo rigorosas normas de fabrico para satisfazer os níveis de qualidade exigidos. O presente Manual inclui todas as informações necessárias relativas à instalação, à eliminação de anomalias e à manutenção. Leia atentamente este Manual antes de abrir o aparelho, ou de realizar qualquer operação de manutenção ao mesmo. O fabricante deste produto não poderá, em circunstância alguma, ser responsabilizado por lesões corporais ou danos materiais na sequência de eventuais erros de instalação, eliminação de anomalias ou intervenção de manutenção sem fundamento. Em qualquer situação, é essencial cumprir as instruções constantes do presente Manual.

Depois de ter lido o presente Manual, guarde-o, com vista a futura utilização.

Pessoal habilitado

- A instalação, as ligações elétricas, a manutenção e as reparações do aparelho devem ser efetuadas por um profissional autorizado conforme os textos regulamentares e as regras da arte em vigor no país onde o aparelho é instalado (cf § 3.4). Para qualquer intervenção no circuito frigorífico, o profissional deve ser titular de um atestado de capacidade para o manuseamento de fluidos refrigerantes..

Para França:

- Instalação elétrica de baixa tensão conforme a NF-C 15-100.
- Legislação sobre o manuseamento dos fluidos refrigerantes: Decreto 2007/737 e suas portarias de aplicação.

Condições de instalação

- Não tente instalar si mesmo este aparelho.
- Este produto foi exclusivamente concebido para um uso doméstico e uma instalação no exterior. O ar que escapa do produto deve poder escoar-se livremente e não deve ser utilizado para outros fins como o aquecimento ou o arrefecimento de uma sala ou de um edifício.
- Esta bomba de aquecimento aquece a água da piscina e mantém uma temperatura constante, e não deve ser utilizada para outros fins.
- Verificar o cabo de alimentação. Se o cabo de alimentação estiver danificado, deve ser substituído pelo fabricante, pelo seu serviço pós-venda ou por uma pessoa qualificada e habilitada.

1. INSTRUÇÕES GERAIS - SEGURANÇA (continuação)

- A ligação do aparelho à terra e a sua continuidade são obrigatórias. O fio de terra deve ser mais longo do que os outros fios para evitar riscos de choque elétrico em caso de arrancamento do cabo. A instalação elétrica deve obrigatoriamente estar equipada com uma proteção diferencial de 30 mA (cf § 3.4).
- Qualquer recomendação não cumprida anula a garantia.

Instruções para a conservação - manutenção

As operações de manutenção devem ser realizadas 1 vez por ano a fim de garantir a longevidade e o bom funcionamento da bomba de aquecimento.

- A manutenção e as diferentes operações devem ser realizadas com a frequência e nos momentos recomendados, como especificado no presente manual.
- Utilize apenas peças sobressalentes de origem.
- Verificar o cabo de alimentação. Se o cabo de alimentação estiver danificado, deve ser substituído pelo fabricante, pelo seu serviço pós-venda ou por uma pessoa qualificada e habilitada.
- Verificar a ligação do aparelho à terra e a sua continuidade.
- Limpar o evaporador com a ajuda de uma escova macia ou jacto de ar ou água (**Atenção, nunca utilizar um aspersor de alta pressão**).
- Verificar o bom escoamento dos condensados.
- Verificar o aperto das ligações hidráulicas e eléctricas
- Verificar a estanqueidade hidráulica do condensador.
- **Solicitar a um profissional** com formação que verifique a impermeabilidade do circuito frigorífico através do detetor de fugas.



Antes de qualquer operação de manutenção a bomba de aquecimento deve ser desligada de qualquer fonte de corrente eléctrica. As operações de manutenção devem ser realizadas unicamente por pessoal qualificado e habilitado para manipular fluidos de refrigeração..

Instruções para o Inverno

- Colocar a bomba de aquecimento em Modo “OFF”.
- Cortar a alimentação da bomba de aquecimento.
- Esvaziar o condensador com a ajuda do dreno para evitar qualquer risco de degradação. (risco importante de congelação).
- Fechar a válvula de “by-pass” e desapertar as uniões de entrada/saída.
- Expulsar ao máximo a água residual do condensador com a ajuda de uma pistola de ar.

1. INSTRUÇÕES GERAIS - SEGURANÇA (continuação)

- Obturar a entrada e a saída de água na bomba de aquecimento para evitar a entrada de corpos estranhos.
- Cobrir a bomba de aquecimento com a capa de Inverno prevista para este efeito.



Qualquer dano ocasionado por deficiente preparação para o Inverno implica a anulação da garantia..

Condições de utilização

Este aparelho pode ser utilizado por crianças com pelo menos 8 anos de idade assim como por pessoas com capacidades físicas, sensoriais ou mentais reduzidas, ou sem experiência ou conhecimentos, se forem corretamente supervisionadas ou se tiverem recebido instruções relativas à utilização do aparelho com toda a segurança e os riscos incorridos tiverem sido compreendidos.

As crianças não devem brincar com o aparelho.

A limpeza e a conservação pelo utilizador não devem ser efetuadas por crianças sem vigilância.

Este produto contém gás refrigerante R410A

Este produto contém gases com efeito de estufa fluorados que estão enquadrados pelo protocolo de Quioto.

Não libertar estes gases na atmosfera.

Valor GWP(1) : 2088, valor baseado no 4.º relatório do GIEC

A quantidade de refrigerante baseada na regulamentação F-Gás n.º 517/2014 está indicada na placa de identificação da unidade.

Toda a intervenção sobre o circuito frigorífico deve ser efetuada por um profissional autorizado como especificado anteriormente.

Podem ser requeridas inspeções periódicas em função da legislação europeia ou local. Queira contactar o seu distribuidor local para mais informações.

- Atenção, os fluidos refrigerantes podem ser inodoros.
- Não perfurar ou aquecer a tubagem, risco de explosão e de queimaduras graves.
- Não utilizar meios de aceleração do processo de degelo ou de limpeza que não sejam os recomendados pelo fabricante.
- O aparelho deve ser armazenado num local que não contenha fontes de inflamação funcionando em permanência (por exemplo: chamas abertas, aparelho de gás ou radiador elétrico em funcionamento).

(1) Potencial de aquecimento global

2. CARACTERÍSTICAS TÉCNICAS

2.1 Dados técnicos da bomba de aquecimento



Modelo	ENERGYLINE PRO	ENP10TAS
Capacidad calorífica *	kW	36,9
Potencia eléctrica absorbida *	kW	6,87
Corriente de funcionamiento *	A	14,8
Tensión de alimentación	V / Ph / Hz	400 V / 3N~ / 50Hz
Calibre de fusible tipo aM	A	20
Disyuntor curva D	A	20
Número de compresores	/	1
Tipo de compresor	/	Scroll
Número de ventiladores	/	2
Potencia del ventilador	W	50 - 225
Velocidad de rotación de los ventiladores	RPM	600 - 1050
Ventilación	/	Horizontal
Nivel de presión acústica (a 10 m) LpA	dB(A)	41
Conexión hidráulica	mm	63
Caudal nominal de agua*	m ³ /h	13
Pérdida de carga sobre el agua (max)	kPa	13,8
Dimensiones netas de la unidad (L/a/a)	mm	1482 / 485 / 1480
Peso neto de la unidad	kg	182

* Desempenho em conformidade com a norma de teste NF EN 14511 incluída no referencial NF-414.
Ar seco 15°C - Humidade relativa 71% - Temperatura de entrada de água 26°C.

2. CARACTERÍSTICAS TÉCNICAS (continuação)

2.2 Período de funcionamento

Utilizar a bomba de aquecimento nos seguintes intervalos de temperatura e humidade para assegurar um funcionamento seguro e eficaz.

	Modo de aquecimento 	Modo de Refrigeração 
Temperatura exterior	-12°C ~ +35°C	+7°C ~ +43°C
Temperatura da água	+12°C ~ +40°C	+8°C ~ +40°C
Humidade relativa	< 80%	< 80%
Intervalo de Ajuste do ponto de afinação	+15°C ~ +32°C	+8°C ~ +32°C



Se a temperatura e a humidade não corresponderem a estas condições, podem disparar os dispositivos de segurança e a bomba de aquecimento pode deixar de funcionar.



A temperatura máxima de aquecimento é limitada à 32°C a fim de evitar a deterioração dos liners. Hayward declina qualquer responsabilidades em caso de utilização que ultrapassa os +32°C.

2. CARACTERÍSTICAS TÉCNICAS (continuação)

2.3 Dimensões

Modelo: ENP10TAS

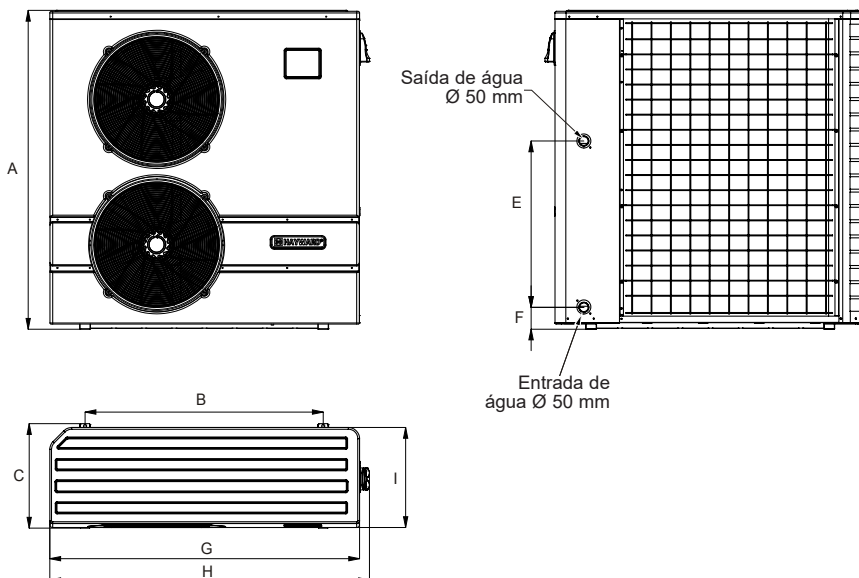

Unidade : mm

Modelo	ENP10TAS
Referência	
A	1480
B	1105
C	485
D	/
E	771,5
F	101,5
G	1437
H	1483
I	464

3. INSTALAÇÃO E LIGAÇÃO

3.1 Esquema de princípio

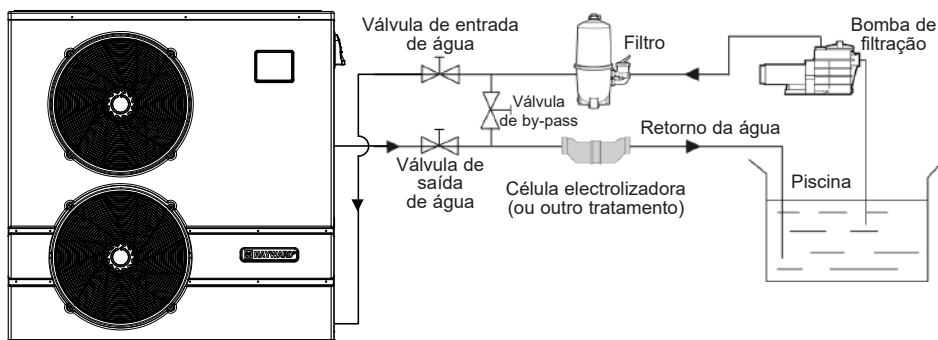

Nota: A bomba de aquecimento é fornecida sem qualquer equipamento de tratamento ou filtração. Os elementos presentes no esquema são peças a fornecer pelo instalador.

3.2 Bomba de aquecimento



Colocar a bomba de aquecimento no exterior e fora de qualquer local técnico fechado.

Escolher uma localização de preferência ensolarada e ao abrigo de ventos dominantes.

O aparelho deve estar perfeitamente acessível para os trabalhos de instalação e de manutenção ulteriores.

Colocada sob abrigo, devem ser respeitadas as distâncias mínimas prescritas abaixo a fim de evitar qualquer risco de recirculação de ar e de degradação dos desempenhos globais da bomba de aquecimento.

Unidad : mm

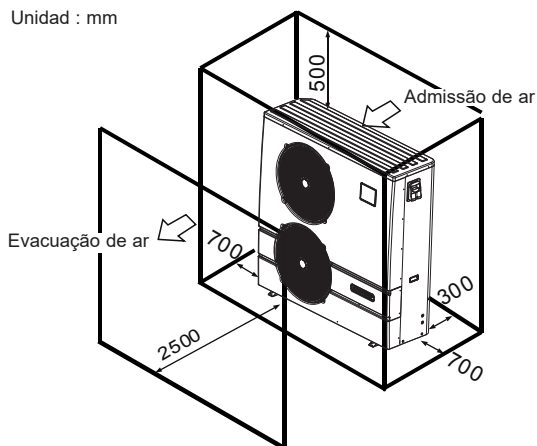

3. INSTALAÇÃO E LIGAÇÃO (continuação)



Não colocar o aparelho diretamente no solo porque isto pode provocar perturbações.

A posição no solo sobre blocos anti-vibrações deve ser privilegiada. Um suporte de parede não deve ser utilizado em condições suscetíveis de transmitir vibrações.

Não instalar a bomba de calor sobre um suporte suscetível de amplificar as vibrações da unidade.

Não instalar a bomba de calor num lugar suscetível de amplificar o seu nível sonoro ou num lugar onde o ruído da unidade possa incomodar a vizinhança.

Não utilizar adesivos: estes não são considerados como meios de fixação fiáveis.

Instalar de preferência a bomba de calor sobre uma laje de betão plana e dessolidarizada ou uma caixa de fixação prevista para este efeito e montar a bomba de aquecimento sobre os blocos amortecedores fornecidos (parafusos e anilhas fornecidos).

Fixar o aparelho respeitando o aperto indicado para evitar qualquer risco de acidente ou danos para os materiais e as pessoas.

Outra possibilidade: instalar a bomba de calor no solo sobre suportes em borracha, utilizando um conjunto de parafusos adaptado (não fornecido).

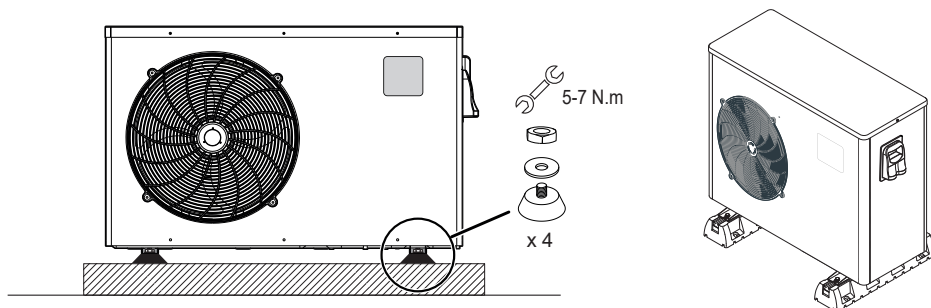

Distância máxima de instalação entre a bomba de aquecimento e a piscina 15 metros.

Comprimento total ida e volta das canalizações hidráulicas 30 metros. Isolar as canalizações hidráulicas de superfície e enterradas.

A bomba de calor deve ser instalada a uma distância mínima da piscina de acordo com a norma NF C 15-100 (ou seja, a 3,5 m da massa de água, em França) ou com as normas de instalação em vigor noutros países.

Não instalar a bomba de calor junto a fontes de calor.

Em caso de instalação em regiões com ocorrência de neve, recomenda-se manter a máquina abrigada para evitar a acumulação de neve no evaporador.

3. INSTALAÇÃO E LIGAÇÃO (continuação)

3.3 Ligação hidráulica

A bomba de aquecimento é fornecida com duas uniões de 50 mm de diâmetro. Utilizar tubo PVC para canalização hidráulica Ø 50 mm. Ligar a entrada de água da bomba de aquecimento à conduta proveniente do grupo de filtração e, em seguida, ligar a saída de água da bomba de aquecimento à conduta de água que segue para a bacia (consultar esquema abaixo).

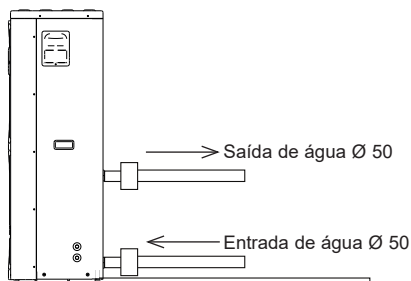

Instalar uma válvula dita de “by-pass” entre a entrada e a saída da bomba de aquecimento.



Se for utilizado um distribuidor automático, deve obrigatoriamente ser instalado após a bomba de aquecimento a fim de proteger o condensador Titane contra uma concentração demasiado elevada de produto químico.



Tenha o cuidado de instalar a bomba de by-pass e as uniões fornecidas ao nível de entrada e saída de água da unidade, a fim de simplificar a purga durante o período de Inverno, facilitar o acesso ou a respectiva desmontagem para manutenção.

3. INSTALAÇÃO E LIGAÇÃO (continuação)

3.4 Ligação eléctrica



A instalação eléctrica e a cablagem deste equipamento devem estar em conformidade com a regras de instalação locais em vigor.

F	NF C15-100	GB	BS7671:1992
D	DIN VDE 0100-702	EW	EVHS-HD 384-7-702
A	ÖVE 8001-4-702	H	MSZ 2364-702/1994/MSZ 10-553 1/1990
E	UNE 20460-7-702 1993, RECBT ITC-BT-31 2002	M	MSA HD 384-7-702.S2
IRL	Regras de cablagem + IS HD 384-7-702	PL	PN-IEC 60364-7-702:1999
I	CEI 64-8/7	CZ	CSN 33 2000 7-702
LUX	384-7.702 S2	SK	STN 33 2000-7-702
NL	NEN 1010-7-702	SLO	SIST HD 384-7-702.S2
P	RSIUEE	TR	TS IEC 60364-7-702



Verifique que a alimentação eléctrica disponível e a frequência da rede correspondem à corrente de funcionamento requerida, tendo em conta a localização específica do equipamento, e a corrente necessária para alimentar qualquer outro aparelho ligado ao mesmo circuito.

ENP10TAS 400 V \sim +/- 10 % 50 Hz 3 fases



Verificar que o equilíbrio das fases não excede os 2%

Observe o esquema de cablagem correspondente em anexo.

A caixa de ligações encontra-se do lado direito da unidade. Três ligações destinam-se à alimentação eléctrica, e duas ao comando da bomba de filtração (Servocomando).

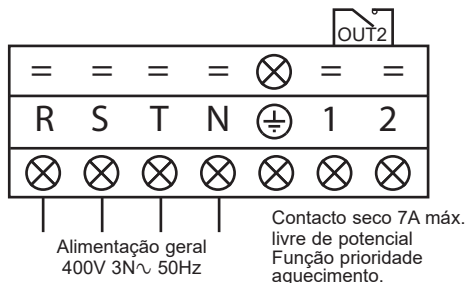

3. INSTALAÇÃO E LIGAÇÃO (continuação)



Nunca utilizar uma tomada de corrente para a alimentação.
A linha de alimentação eléctrica deve ser dotada, de maneira apropriada, de um dispositivo de proteção omnipolar do tipo disjuntor curva D, assim como de um disjuntor diferencial de proteção 30 mA (ver tabela abaixo).

Modelo		ENP10TAS
Alimentação eléctrica	V/Ph/Hz	400V 3N~ 50Hz
Calibre fusível tipo aM	A	20 aM
Disjuntor curvo D	A	20 D
Secção de cabo	mm ²	5G4 5 x 4



Utilizar o cabo de alimentação do tipo RO 2V / R 2V ou equivalente.



As secções de cabo são fornecidas para um comprimento máximo de 25 m. Devem no entanto ser verificadas e adaptadas em função das condições de instalação.



Tenha sempre o cuidado de interromper a alimentação principal antes de abrir a caixa de comando eléctrico.

3.5 Primeira colocação em serviço

Procedimento de arranque - uma vez a instalação terminada, seguir e respeitar as etapas seguintes:

- 1) Faça girar os ventiladores com a mão a fim de verificar que ele pode girar livremente com a mão, e que a hélice está fixada correctamente sobre o eixo do motor.
- 2) Assegure-se que a unidade está correctamente ligada à alimentação principal (ver esquema de cablagem em anexo).
- 3) Active a bomba de filtração.
- 4) Verifique que todas as válvulas de água estão abertas, e que a água flui para a unidade antes de passar ao modo de aquecimento ou refrigeração.
- 5) Verifique que o tubo de purga de condensados está correctamente fixado e não apresenta nenhuma obstrução.
- 6) Active a alimentação eléctrica destinada à unidade, depois prima a tecla Marche/Arrêt (Marcha/Paragem)  no painel de comando.

3. INSTALAÇÃO E LIGAÇÃO (continuação)

- 7) Verifique que não aparece nenhum código de ALARME quando a unidade está ON (Ligado) (ver guia de resolução de avarias).
- 8) Fixe o débito de água com a ajuda da válvula de by-pass (ver § 3.6 e 2.1), conforme previsto respectivamente para cada modelo, de modo a obter uma diferença de temperatura Entrada/Sáida de 2°C.
- 9) Após um funcionamento de alguns minutos, verifique que o ar que sai da unidade é refrigerado (entre 5 e 10°).
- 10) Com a unidade em serviço, desactive a bomba de filtração. A unidade deve parar automaticamente e apresentar o código de erro E03.
- 11) Faça funcionar a unidade e a bomba da piscina 24 horas sobre 24, até que seja atingida a temperatura da água pretendida. Quando a temperatura de entrada de água atingir o valor de afinação, a unidade pára. Volta então a arrancar automaticamente (desde que a bomba da piscina esteja em serviço) se a temperatura da piscina for inferior em pelo menos 0,5°C à temperatura regulada.

Controlador de débito - A unidade é dotada de um controlador de débito que activa a bomba de calor quando a bomba de filtração da piscina está em serviço, e desactiva-a quando a bomba de filtração está fora de serviço. Por falta de água, aparece no regulador o código de alarme E03 (Ver § 6.4).

Temporização - a unidade integra uma temporização de 3 minutos, a fim de proteger os componentes do circuito de comando, eliminar qualquer instabilidade em termos de re-arranque e qualquer interferência ao nível do contactor. Graças a esta temporização, a unidade voltar a arrancar automaticamente cerca de 3 minutos após qualquer corte do circuito de comando. Mesmo um corte de corrente de curta duração activa a temporização de arranque.

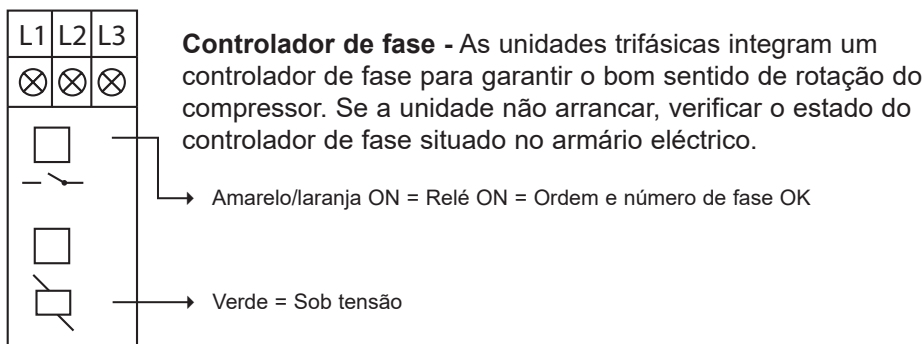

3. INSTALAÇÃO E LIGAÇÃO (continuação)

3.6 Ajuste do débito de água

Com as válvulas de entrada e saída de água abertas, ajustar a válvula de “by-pass” de modo a obter uma diferença de 2°C entre a temperatura de entrada e saída de água (ver esquema de princípio § 3.1). Pode verificar a Ajuste visualizando as temperaturas de entrada/saída directamente no painel de comando.

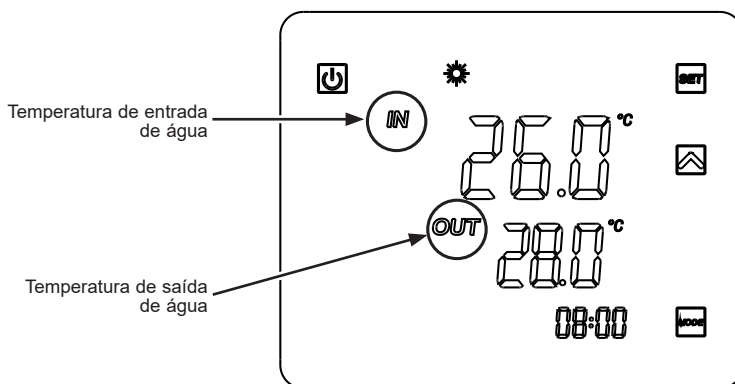

Nota: A abertura da válvula de “by-pass” provoca um débito menor, logo um aumento da ΔT .

O fecho da válvula de “by-pass” provoca um débito maior, logo uma diminuição da ΔT .

4. INTERFACE DO UTILIZADOR

4.1 Apresentação geral

A bomba de aquecimento está equipada com um painel de comando digital com ecrã táctil, ligado electricamente e pré-regulado de fábrica em modo de aquecimento.

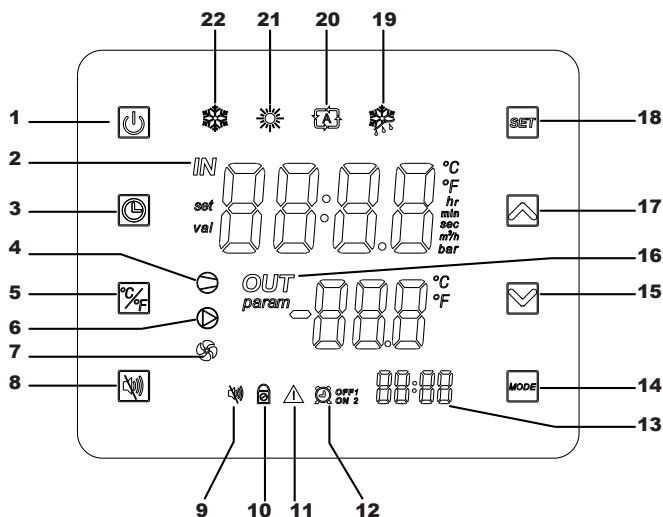

Legenda

1		Marcha/Paragem
2		Entrada de água
3		Ajuste da hora e Timers
4		Compressor ON
5		Conversão °C/°F
6		Contacto seco OUT2
7		Ventilador ON
8		Modo silêncio
9		Indicador do modo silêncio
10		Ecrã bloqueado
11		Alarme

12		Timers 1 e 2 (temporizadores)
13		Hora dos Timers
14		Seleção do modo
15		Deslocamento para baixo/ Diminuir
16		OUT Saída de água
17		Deslocamento para cima/ Aumentar
18		Registar / Ajustar
19		Modo degelo
20		Modo automático
21		Modo aquecimento
22		Mode arrefecimento

4. INTERFACE DO UTILIZADOR (continuação)

Modo OFF (desligado)

Quando a bomba de aquecimento está em espera (Modo OFF) aparece no ecrã do regulador a inscrição “OFF”.

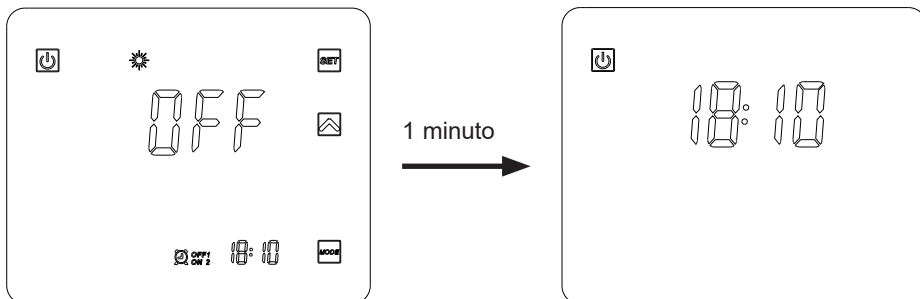

Modo ON (ligado)

Quando a bomba de aquecimento está em funcionamento ou em Ajuste (Modo ON) as temperaturas de entrada e de saída de água são apresentadas no ecrã do regulador.

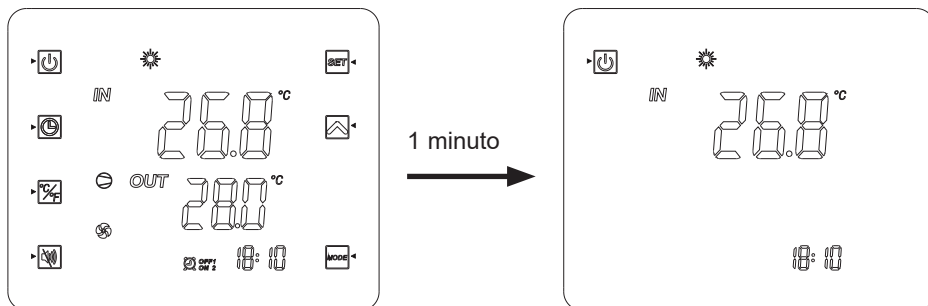











4. INTERFACE DO UTILIZADOR (continuação)

No final dos ajustes, pressione  para confirmar.

Os ajustes estão automaticamente registados após 20 anos sem ação.

4.2 Ajuste do relógio

Se o mostrador estiver em modo de espera, premir o botão  durante alguns segundos.









- 1) Premir  para que o símbolo  apareça.
- 2) Premir , a indicação da hora pisca. Ajustar as horas com os botões  .
- 3) Premir  e ajustar os minutos com os botões  .
- 4) Premir  para registar.

4.3 Ajuste da função Timer (temporizador)











O ajuste desta função é necessária caso pretenda fazer funcionar a bomba de aquecimento por um período mais curto que o definido pelo relógio de filtração. Pode assim programar um arranque diferido e um arranque antecipado ou simplesmente impedir um intervalo horário de funcionamento (por exemplo a noite).

É possível programar 2 Timers de Arranque (ON1 e ON2) e 2 Timers de Paragem (OFF1 e OFF2).

Programação do Timer 1 – Arranque

- 1) Premir  durante 2 seg., o Timer ON1  pisca (*).
- 2) Premir  para ajustar as horas com os botões  .
- 3) Premir  para ajustar os minutos com os botões  .
- 4) Premir  para registar.

Programação do Timer 1 – Paragem

- 1) Premir  durante 2 seg., o Timer ON1  pisca (*).
Premir uma vez , o Timer OFF1  pisca.
- 2) Premir  para ajustar as horas com os botões  .
- 3) Premir  para ajustar os minutos com os botões  .
- 4) Premir  para registar.

(*) Para aceder diretamente ao Timer ON2 , premir  durante 2 seg., pois premir 2 vezes .



4. INTERFACE DO UTILIZADOR (continuação)

Programação do Timer 2



Após os ajustes do Timer 1, é possível aceder diretamente aos ajustes do

Timer 2 :  e .



Proceda da mesma maneira que para o Timer 1.

Nota: Para aceder diretamente ao Timer ON2 , premir  durante 2 seg., pois premir 2 vezes .



Supressão dos Timers (Départ et Arrêt)

1) Premir  durante 2 seg., o Timer ON1  pisca (*).

2) Premir , a indicação da hora pisca.



3) Premir  para cancelar o Timer .



4) Premir  para validar.

5) Premir  durante 2 seg., o Timer ON1  pisca.

Premir uma vez , o Timer  pisca. (*)

6) Premir , a indicação da hora pisca.

7) Premir  para cancelar o Timer .

(*) Para aceder aos Timers 2  ou , seguir as etapas 1)- 4), depois premir 2 vezes . Proceda da mesma maneira do que acima.

4.4 Escolha do modo de funcionamento

Em Modo “OFF” ou “ON”

Premir  para mudar o modo: arrefecimento, aquecimento ou automático.

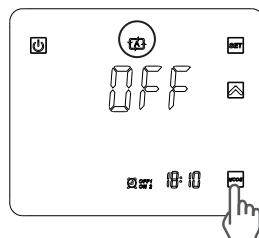
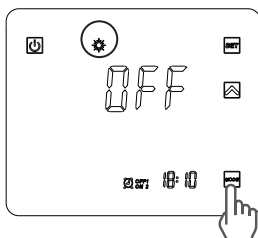
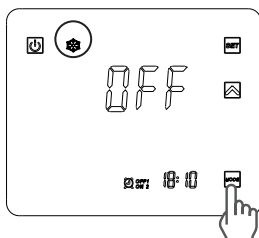



Se a bomba de aquecimento é definida em apenas aquecimento ou arrefecimento modo só, a mudança do modo não é possível.

4. INTERFACE DO UTILIZADOR (continuação)

4.5 Ajuste e visualização do ponto de ajuste



(Temperatura da água pretendida)

Se o botão  não estiver visível no ecrã, premir brevemente .

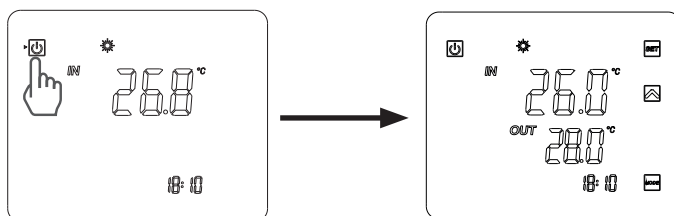
(Em funcionamento ou parado, basta premir o botão  para visualizar o ponto de ajuste.)



Em Modo “OFF” ou Modo “ON”



Premir  para visualizar o ponto de ajuste ; depois premir  ou  para definir o ponto de ajuste pretendido.



O ajuste efectua-se com uma precisão de 0,5 °C.



É recomendável nunca ultrapassar a temperatura de 30°C para evitar a alteração das juntas.

4.6 Bloqueio e libertação do ecrã táctil

Premir o botão  durante 5 seg. até a emissão de um bipe e o aparecimento do símbolo .

Para desbloquear, premir  durante 5 seg. até a emissão de um bipe e o desaparecimento do símbolo .

4. INTERFACE DO UTILIZADOR (continuação)

4.7 Ajustamento do modo silêncio



Esta função permite a utilização da bomba de calor com uma velocidade de rotação dos ventiladores reduzida à 600Tr/min durante 8 horas no máximo, a fim de limitar os danos sonoros em período nocturno e/ou diurno de acordo com a localização da bomba de calor em relação à vizinhança e/ou a bacia. Esta função pode ser Activada/Desactivada manualmente ou usando um temporizador.

Activação manual

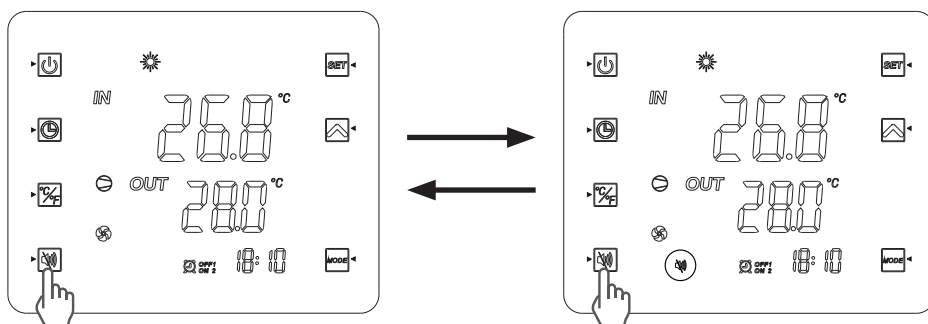
- 1) Premir o botão .
- 2) A indicação abaixo aparece no ecrã : o modo Silêncio está activado paras as 8 horas seguintes.
- 3) Os ventiladores reduzem progressivamente a velocidade de rotação para uma duração de 8 horas no máximo.
- 4) Após 8 horas de funcionamento a função será automaticamente desactivada e os ventiladores retomarão uma velocidade de rotação em função da temperatura do ar exterior.





Desactivação manual

- 1) Premir o botão .
- 2) O indicador  desaparece do ecrã: o modo Silêncio está desactivado.
- 3) Os ventiladores ajustam a velocidade de rotação em função da temperatura exterior do ar.

4. INTERFACE DO UTILIZADOR (continuação)



Programação do modo SILÊNCIO

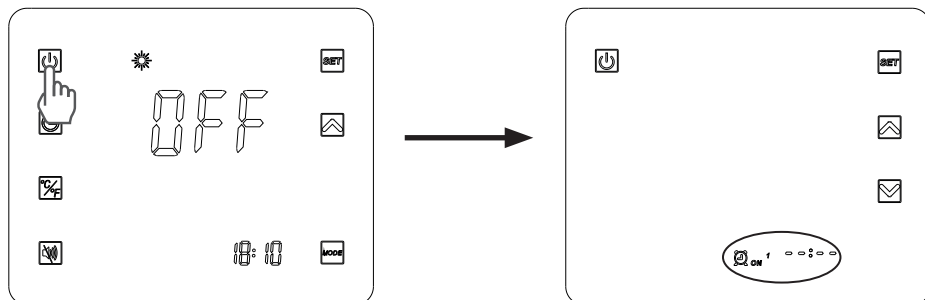

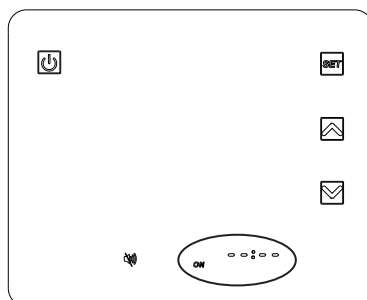

1) Premir  durante 2 seg., o Timer ON1  ON1 ¹ pisca .



2) Premir 4 vezes  até aceder ao ecrã indicado abaixo.









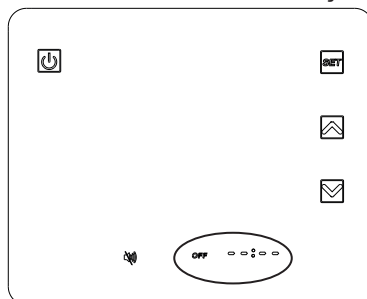

3) Premir , a indicação das horas pisca. Utilizar as setas   para ajustar as horas de início.

4) Premir , a indicação dos minutos pisca. Utilizar as setas   para ajustar os minutos de início. Premir  para validar.

5) Premir  para ajustar a hora de fim : a indicação **OFF** pisca.



4. INTERFACE DO UTILIZADOR (continuação)

- 6) Premir , a indicação das horas pisca. Utilizar as setas   para ajustar as horas de fim.
- 7) Premir , a indicação dos minutos pisca. Utilizar as setas   para ajustar os minutos de fim. Premir  para validar.
- 8) premir  para voltar ao ecrã anterior.
As indicações ON-OFF aparecem como no ecrã abaixo.

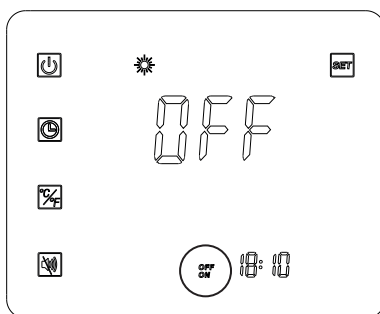

Nota : O passo de ajustamento dos minutos é de 10 em 10.

Uma vez o ajustamento do modo SILENCE terminado, este fica activo por defeito 7j/7j.

5. MANUTENÇÃO E PREPARAÇÃO PARA O INVERNO

5.1 Manutenção

Estas operações de manutenção devem ser realizadas 1 vez por ano a fim de garantir a longevidade e o bom funcionamento da bomba de aquecimento.

- A manutenção e as reparações do aparelho devem ser efectuada por um profissional autorizado conforme os textos regulamentares e as regras da arte em vigor no país onde o aparelho é instalado (cf § 3.4). Para qualquer intervenção no circuito frigorífico, o profissional deve ser titular de um atestado de capacidade para o manuseamento de fluidos refrigerantes.
- Verificar o cabo de alimentação. Se o cabo de alimentação estiver danificado, deve ser substituído pelo fabricante, pelo seu serviço pós-venda ou por uma pessoa qualificada e habilitada.
- Verificar a ligação do aparelho à terra e a sua continuidade.
- Limpar o evaporador com a ajuda de uma escova macia ou jacto de ar ou água (**Atenção, nunca utilizar um aspersor de alta pressão**).
- Verificar o bom escoamento dos condensados.
- Verificar o aperto das ligações hidráulicas e eléctricas
- Verificar a estanqueidade hidráulica do condensador.
- **Solicitar a um profissional** com formação que verifique a impermeabilidade do circuito frigorífico através do detetor de fugas.



Antes de qualquer operação de manutenção a bomba de aquecimento deve ser desligada de qualquer fonte de corrente eléctrica. As operações de manutenção devem ser realizadas unicamente por pessoal qualificado e habilitado para manipular fluidos de refrigeração.

5.2 Preparação para o Inverno

- Colocar a bomba de aquecimento em Modo “OFF”.
- Cortar a alimentação da bomba de aquecimento.
- Esvaziar o condensador com a ajuda do dreno para evitar qualquer risco de degradação. (risco importante de congelação).
- Fechar a válvula de “by-pass” e desapertar as uniões de entrada/saída.
- Expulsar ao máximo a água residual do condensador com a ajuda de uma pistola de ar.
- Obturar a entrada e a saída de água na bomba de aquecimento para evitar a entrada de corpos estranhos.
- Cobrir a bomba de aquecimento com a capa de Inverno prevista para este efeito.



Qualquer dano ocasionado por deficiente preparação para o Inverno implica a anulação da garantia.

6. ANEXOS

6.1 Esquema eléctrico

ENP10TAS

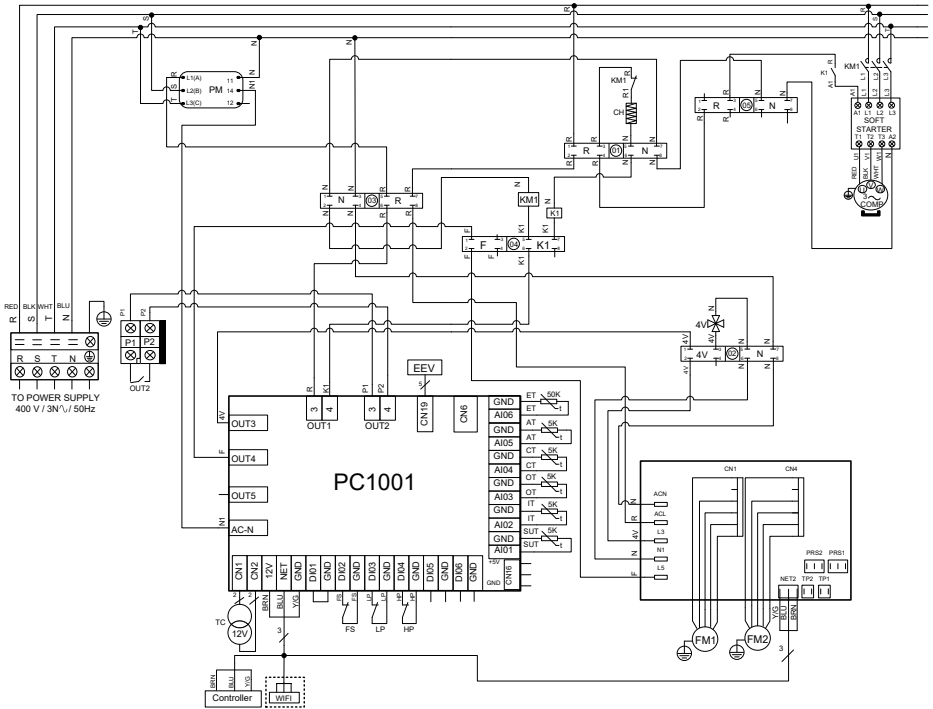

OBSERVAÇÕES:

- AT : SONDA DE TEMPERATURA DO AR
- COMP : COMPRESSOR
- CT : SONDA TEMPERATURA EVAPORADOR
- EEV : REGULADOR ELECTRÓNICO
- FM1-2 : MOTOR VENTILADOR
- FS : DETECTOR PRESENÇA DE ÁGUA
- HP : PRESSÓSTATO ALTA PRESSÃO
- IT : SONDA DE TEMPERATURA ENTRADA DE ÁGUA
- LP : PRESSÓSTATO BAIXA PRESSÃO

- OT : SONDA DE TEMPERATURA SAÍDA DE ÁGUA
- SUT : SONDA DE TEMPERATURA DE ASPIRAÇÃO
- TC : TRANSFORMADOR 230V~/ 12V~
- 4V : VÁLVULA DE 4 VIAS
- KM1 : CONTACTOR DE POTÊNCIA COMPRESSOR
- PM : CONTROLADOR DE FASE
- CH1 : RESISTÊNCIA DE CAIXA
- ET : SONDA DE TEMPERATURA DE DESCARGA
- OUT2 : CONTACTO SECO LIVRE DE POTENCIAL 7A MÁX
- OPÇÃO

6. ANEXOS (continuação)

6.2 Ligações prioridade aquecimento bomba trifásica

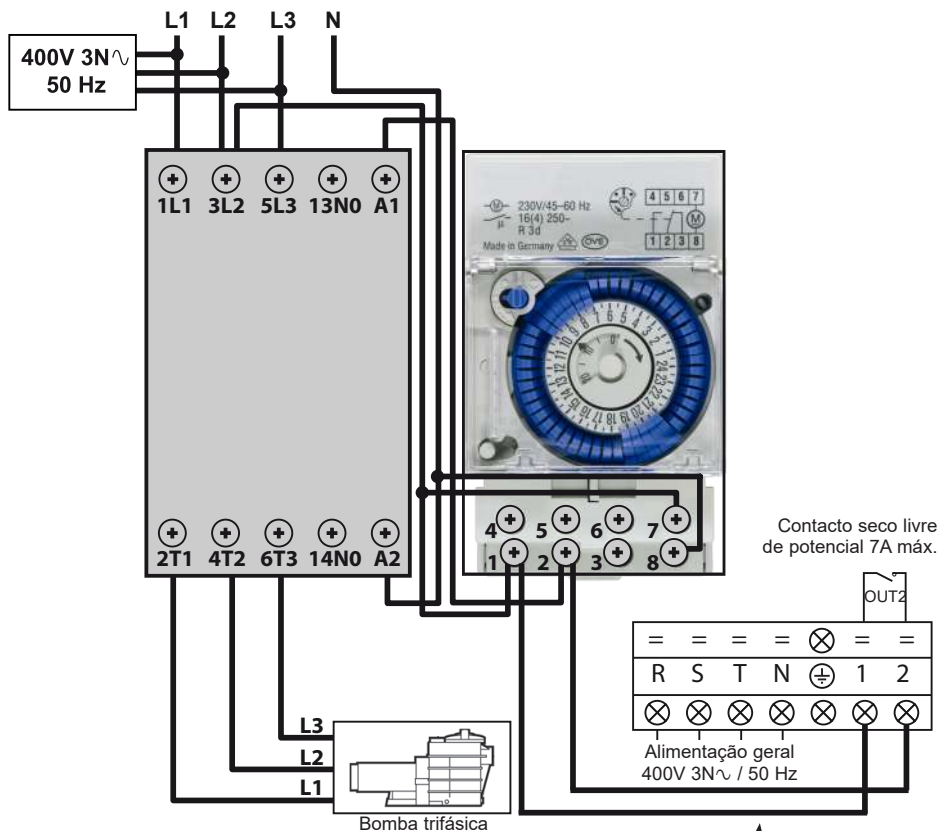

Os terminais 1 e 2 emitem um contacto seco livre de potencial, sem polaridade de 230 V \sim / 50 Hz.

Cablar os terminais 1 e 2 respeitando a cablagem indicada acima, a fim de controlar o funcionamento da bomba de filtração por ciclo de 2 minutos todas as horas se a temperatura da bacia for inferior ao ponto recomendado.

 Nunca conecte a alimentação da bomba de filtração directamente sobre os terminais 1 e 2.



Página deixada em branco intencionalmente

6. ANEXOS (continuação)

6.3 Vistas explodidas e peças sobressalentes

ENP10TAS

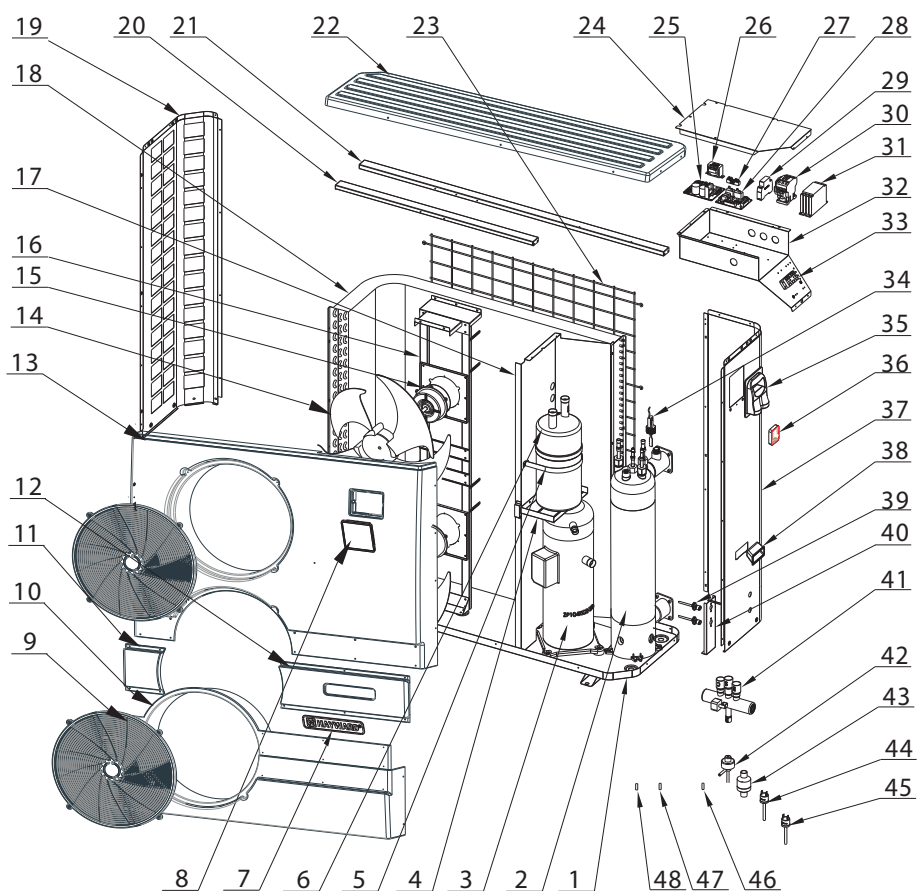

6. ANEXOS (continuação)

ENP10TAS

Rep	Ref..	Designação	Rep	Ref..	Designação
1	HWX32005210049	Fundo	27	HWX20003909	Bloco de terminais 2 conexões
2	HWX32005120009	Condensador Titânio/ PVC	28	HWX950531014516	Placa electrónica
3	HWX20000110153	Compressor	29	HWX200036023	Controlador de fase
4	HWX32027210011	Suporte de reservatório líquido	30	HWX20000360209	Contactador do compressor tri
5	HWX32027210013	Braçadeira de mangueira	31	HWX20000360092	Arrancador electrónico tri
6	HWX35141402	Depósito de líquido	32	HWX32005210054	Quadro elétrico
7	HWX20000230596	Logotipo Hayward	33	HWX20000390180	Terminal de 5 ligações trifásico
8	HWX95005010018	Regulador LED	34	HWX200036005	Detector de débito de água
9	HWX32020220001	Grelha de protecção do ventilador	35	HWX32009220032	Alçapão de acesso eléctrico
10	HWX32005220002	Painel frontal inferior	36	HWX95005010014	Módulo WiFi
11	HWX32005220005	Painel decorativo esquerdo	37	HWX32005210060	Painel direito
12	HWX32005220004	Painel decorativo direito	38	HWX32008220037	Pega
13	HWX32005220001	Painel frontal superior	39	HWX20000140353	Tomada de pressão AP&BP
14	HWX20000270025	Hélice ventilador	40	HWX32019210038	Placa de suporte tomadas HP/LP
15	HWX20000330361	Motor DC	41	HWX20011488	Válvula de 4 vias
16	HWX32005210058	Suporte do motor	42	HWX20000140338	Regulador electrónico
17	HWX32005210065	Painel de separação	43	HWX20041455	Filtro
18	HWX32005120008	Evaporador	44	HWX20003603	Pressóstato de baixa pressão
19	HWX32005210051	Painel esquerdo	45	HWX20013605	Pressóstato de alta pressão
20	HWX32005220055	Enrijecedor curto	46/47	HWX20003242	Sonda temperatura evaporador/ar/água
21	HWX32005210056	Enrijecedor longo	48	HWX20003223	Sonda compressor 50 kΩ
22	HWX32005220003	Painel superior	*49*	HWX20000240208	Cobertura de inverno
23	HWX32005210063	Protecção Evaporador	*50*	HWX200026009	Junta tórica ID 48-Ep 5 mm
24	HWX32005210053	Painel de protecção eléctrica	*51*	HWX200026061	Junta tórica ID 43-Ep 3,4 mm
25	HWX950531024107	Módulo DC Inverter	*52*	HWX20003214	Resistência de carácter
26	HWX200037003	Transformador 230V _~ - 12V _~	*53*	HWX20002625	Bloco silencioso

Nota : As marcas *xx *não estão referenciadas na vista explodida correspondente.

6. ANEXOS (continuação)

6.4 Guia de resolução de avarias



Certas operações devem ser realizadas por um técnico habilitado.

Em caso de falha, as indicações seguintes aparecem no ecrã:

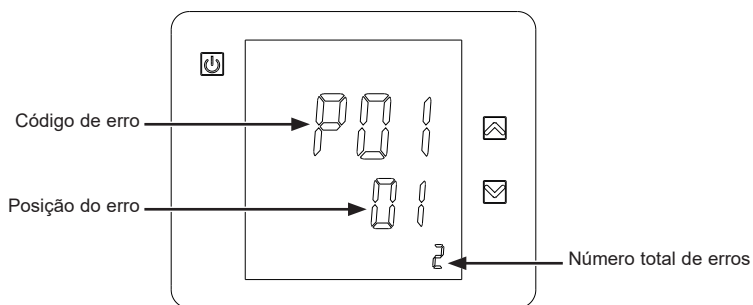

Em caso de vários erros, pressionar  ou  para percorrer os códigos de erro. Consultar a tabela seguinte.

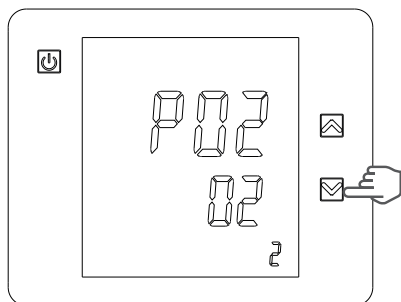

6. ANEXOS (continuação)

Avaria	Códigos de erro	Descrição	Solução
Avaria sonda de entrada de água	P01	O sensor está aberto ou apresenta curto-circuito.	Verificar ou substituir o sensor.
Avaria sonda de saída de água	P02	O sensor está aberto ou apresenta curto-circuito.	Verificar ou substituir o sensor.
Avaria sonda descongelação	P05	O sensor está aberto ou apresenta curto-circuito.	Verificar ou substituir o sensor.
Avaria sonda temperatura exterior	P04	O sensor está aberto ou apresenta curto-circuito.	Verificar ou substituir o sensor.
Defeito sonda de aspiração compressor	P07	O sensor está aberto ou apresenta curto-circuito.	Verificar ou substituir o sensor.
Diferença de temperatura excessiva entre a água na saída e a água na entrada	E06	Débito de água em volume insuficiente, diferença de pressão de água demasiado fraco / elevada.	Verificar o débito de água, ou a obstrução do sistema.
Protecção Antigelado Modo frio	E07	Quantidade de água na saída insuficiente.	Verificar o débito de água, ou o sensor de temperatura da água na saída.
Protecção antigelo de nível 1	E19	Temperatura ambiente, ou na água de entrada, demasiado baixa.	
Protecção antigelo de nível 2	E29	Temperatura ambiente, ou na água de entrada ainda mais baixa.	
Protecção de alta pressão	E01	Pressão do circuito refrigerador demasiado elevada, ou débito de água demasiado fraco, ou evaporador obstruído, ou débito de ar insuficiente.	Verificar o pressóstato de alta pressão e a pressão do circuito refrigerador. Verificar o débito de ar ou de água. Verificar o bom funcionamento do controlador de débito. Verificar a abertura das válvulas de entrada/saída de água. Verificar a Ajuste da válvula de by-pass.
Protecção de baixa pressão	E02	Pressão do circuito de refrigeração demasiado fraco, ou débito de ar demasiado fraco ou evaporador obstruído.	Verificar o pressóstato de baixa pressão de baixa pressão e a pressão do circuito refrigerador para avaliar se existe fuga. Limpar a superfície do evaporador. Verificar a velocidade de rotação do ventilador. Verificar a livre circulação de ar através do evaporador.
Avaria detector de débito	E03	Débito de água insuficiente ou detector em curto-circuito ou avariado	Verificar o débito de água, a bomba de filtração e o detector de débito para ver se apresentam eventuais anomalias de funcionamento.
Problema de comunicação	E08	Anomalia de funcionamento do controlador LED ou da ligação PCB.	Verificar a conexão dos cabos NET e NET 1.
O compressor não arranca	E08	Falta uma fase ou ordem das fases incorrecta	verificar a presença das 3 fases modificar a ordem das fases ao nível do terminal ligação eléctrica à bomba de calor

6. ANEXOS (continuação)

6.5 Garantia

CONDIÇÕES DE GARANTIA

Todos os produtos HAYWARD são garantidos contra todos os defeitos de fabrico ou de matéria-prima durante um período de dois anos a contar da data de aquisição. Qualquer reclamação de garantia deverá ser acompanhada de uma prova de compra contendo a data. Recomendamos, assim, que conserve a sua factura.

A garantia HAYWARD é limitada à reparação ou substituição, por opção da HAYWARD, dos produtos defeituosos desde que tenham sido submetidos a uma utilização normal, em conformidade com as prescrições mencionadas no respectivo manual de utilização, que o produto não tenha sido modificado de nenhuma forma e tenha sido utilizado unicamente com componentes e peças da HAYWARD. Os danos devidos ao gelo e aos ataques de agentes químicos não são garantidos. Todas as outras despesas (transporte, mão-de-obra...) estão excluídas da garantia.

A HAYWARD não poderá ser considerada responsável por qualquer dano directo ou indirecto proveniente da instalação, da ligação ou do funcionamento incorrecto do produto.

Para fazer aplicar uma garantia ou solicitar a reparação ou substituição de um artigo, dirija-se ao seu revendedor. Não será aceite qualquer devolução de material à nossa fábrica sem o nosso acordo prévio por escrito.

As peças de desgaste não se encontram cobertas pela garantia.

6.6 Fim de vida do aparelho



O símbolo da lixeira barrada relativo ao tratamento e à revalorização dos detritos elétricos e eletrónicos significa que em caso algum os produtos devem ser descartados com o lixo doméstico, com os itens volumosos ou num aterro.

Em fim de vida, o aparelho deve ser objeto de uma recolha seletiva com vista à sua reciclagem ou revalorização. Um circuito específico de recuperação para este tipo de produtos foi implementado nos países da União Europeia e na Noruega.

Contactar o instalador ou o representante local para proceder à recolha, ao desmantelamento e à reciclagem deste aparelho.

O retratamento do líquido refrigerante, do óleo e das outras peças deve ser realizado por um profissional qualificado autorizado conforme as legislações locais e nacionais em vigor.

Se o produto contiver pilhas marcadas com este símbolo, isto significa que as pilhas podem conter substâncias nocivas ou poluentes. Neste caso, entregue as pilhas num ponto de recolha de pilhas usadas.

ENERGYLINE PRO

HEIZPUMPENANLAGE FÜR EIN SCHWIMMBECKEN



ENP10TAS

Einbau- & Anleitungshandbuch

INHALTSVERZEICHNIS

1. ALLGEMEINE ANWEISUNGEN - SICHERHEIT	1
2. TECHNISCHE EIGENSCHAFTEN	4
2.1 Technische Angaben zur Heizpumpenanlage	4
2.2 Betriebsbereich	5
2.3 Maße	6
3. INSTALLATION UND ANSCHLUSS	7
3.1 Schematische Darstellung	7
3.2 Heizpumpenanlage	7
3.3 Hydraulischer Anschluss	9
3.4 Elektrischer Anschluss	10
3.5 Erste Inbetriebnahme	11
3.6 Einstellung des Wasserdurchsatzes	13
4. BENUTZEROBERFLÄCHE	14
4.1 Allgemeine Darstellung	14
4.2 Einstellung der Uhr	16
4.3 Einstellung der Timer-Funktion	16
4.4 Wahl des Funktionsmodus	17
4.5 Sperren und Entsperrern des Touchscreen	18
4.6 Einstellung und Anzeige des Sollwerts	18
4.7 Einstellen des Ruhemodus	19
5. WARTUNG UND WINTERZEIT	22
5.1 Wartung	22
5.2 Winterzeit	22
6. ANHANG	23
6.1 Elektrischen Schema	23
6.2 Vorrangige Heizanschlüsse dreiphasige Pumpe	24
6.3 Explosionszeichnungen und Einzelteile	26
6.4 Anleitung zur Fehlerbehebung	28
6.5 Garantie	30
6.6 Entsorgung des ausgedienten Geräts	30

Aufmerksam lesen und für einen späteren Gebrauch aufzubewahren.

Dieses Dokument ist dem Eigentümer des Schwimmbeckens zu übergeben und muss von diesem an einem sicheren Ort aufbewahrt werden.

1. ALLGEMEINE ANWEISUNGEN - SICHERHEIT

Wir bedanken uns bei Ihnen für den Kauf dieser Heizpumpenanlage für ein Schwimmbecken der Marke Hayward Wärmepumpe für Ihr Schwimmbad entschieden haben. Bei der Konzeption dieses Produkts wurde darauf geachtet, dass es den Herstellungsnormen exakt entspricht, damit das hohe Qualitätsniveau erreicht wird. Das vorliegende Handbuch enthält alle erforderlichen Informationen, betreffend Montage, Fehlerbeseitigung und Wartung. Lesen Sie dieses Handbuch bitte vor dem Öffnen der Einheit genau durch, bzw. bei der Durchführung von Wartungsarbeiten an dem Produkt.. Keine Haftung übernimmt der Hersteller dieses Produkt im Fall einer eventuellen Verletzung eines Benutzers oder der Beschädigung des Geräts im Ergebnis eventueller Fehler bei der Montage, der Behebung von Störungen oder einer fehlerhaften Wartung. Die in diesem Handbuch gegebenen Anweisungen müssen stets genau beachtet werden. Nachdem Sie dieses Handbuch gelesen haben, halten Sie es stets zum Nachschlagen bereit.

Zugelassenes Personal

- Installation, Elektroanschlüsse, Wartung und Reparaturen des Geräts müssen von einer technischen Fachkraft durchgeführt werden, die nach den im Land, in dem das Gerät installiert ist, geltenden Bestimmungen zugelassen ist (s. § 3.4). Fachkräfte, die irgendwelche Arbeiten am Kältekreislauf durchführen, müssen ihre Befähigung zum Umgang mit Kältemitteln nachweisen können. Für Frankreich:
 - Elektrische Niederspannungsanlagen gemäß der Norm NF-C 15-100.
 - Gesetzgebung für den Umgang mit Kältemitteln: Dekret 2007/737 und Verfügungen zu dessen Anwendung.

Bedingungen für die Installation

- Versuchen Sie nicht, dieses Gerät selbst zu installieren.
- Dieses Gerät ist ausschließlich für den Hausgebrauch und eine Installation im Freien bestimmt. Aus dem Gerät entweichende Luft muss ungehindert ausströmen können und darf nicht zu irgendwelchen Zwecken, wie zum Heizen oder Kühlen eines Raums oder eines Gebäudes verwendet werden.
- Diese Heizpumpenanlage für ein Schwimmbecken erwärmt das Wasser im Schwimmbad und hält eine konstante Temperatur. Sie darf nicht zu anderen Zwecken genutzt werden.
- Das Netzkabel prüfen. Ist das Netzkabel beschädigt, so muss es vom Hersteller, dessen Kundendienst oder einer hierzu befähigten und zugelassenen Person ersetzt werden.

1. ALLGEMEINE ANWEISUNGEN (Fortsetzung)

- Das Gerät muss unbedingt durchgängig geerdet werden. Zur Vermeidung der Gefahr eines Stromschlags beim Abreißen des Kabels muss der Erdungsleiter länger sein als die anderen Leiter. Die Elektroinstallation muss unbedingt mit einem 30 mA-Fehlerstrom-Schutzschalter versehen sein (s. § 3.4).
- Im Falle einer Nichtbeachtung dieser Anweisungen erlischt der Garantieanspruch.

Anweisungen für Instandhaltung und Wartung

Maßregeln zur Wartung müssen ein Mal pro Jahr durchgeführt werden, um die Langlebigkeit und gute Funktionsweise der Heizpumpenanlage zu garantieren.

- Die Wartung und die verschiedenen Betriebsabläufe müssen gemäß den in diesem Handbuch beschriebenen Zeiträumen und Häufigkeiten durchgeführt werden.
- Benutzen Sie ausschließlich Originalersatzteile.
- Das Netzkabel prüfen. Ist das Netzkabel beschädigt, so muss es vom Hersteller, dessen Kundendienst oder einer hierzu befähigten und zugelassenen Person ersetzt werden.
- Den Erdungsanschluss des Geräts und die Durchgängigkeit des Erdungsleiters prüfen.
- Reinigen Sie den Evaporator mit Hilfe einer flexiblen Bürste, einem Luft- oder einem Wasserstrahl (Achtung: Verwenden Sie niemals einen Hochdruckreiniger).
- Kontrollieren Sie den korrekten Abfluss des Kondensats.
- Kontrollieren Sie die hydraulischen und elektrischen Anschlüsse.
- Kontrollieren Sie die hydraulische Dichtigkeit des Kondensator.
- Die Dichtheit des Kältekreislaufs mithilfe eines Leckdetektors durch eine autorisierte Fachkraft prüfen lassen.



Vor allen Wartungsmaßnahmen muss die Heizpumpenanlage von jeglicher Stromversorgung getrennt werden. Die Wartungsmaßnahmen müssen von einem qualifizierten Fachmann durchgeführt werden, dem der Umgang mit Kälteflüssigkeiten vertraut ist.

Anleitung zum Überwintern

- Stellen Sie die Heizpumpenanlage auf den Modus "OFF".
- Trennen Sie die Heizpumpenanlage von der Stromversorgung.
- Leeren Sie den Kondensator mit Hilfe des Wasserablassers, um jegliche Schadensgefahr zu vermeiden. (großes Frostrisiko).
- Schließen Sie den By-pass-Schieber und lösen Sie die Eingangs- und Ausgangsverbindungsstücke.

1. ALLGEMEINE ANWEISUNGEN (Fortsetzung)

- Entfernen Sie so gut es geht das Altwasser im Kondensator mit Hilfe einer Druckluftpistole.
- Verschließen Sie den Wasserein- und -ausgang an der Heizpumpenanlage, um das Eindringen von Fremdkörpern zu verhindern.
- Decken Sie die Heizpumpenanlage mit der für diesen Zweck vorgesehenen Winterschutzhülle ab.



Jeglicher Schaden, der durch eine schlechte Winterlagerung entsteht, hebt alle Garantieansprüche auf.

Benutzungsbedingungen

Mindestens 8 Jahre alte Kindern, Personen mit eingeschränkten körperlichen, sensorischen oder geistigen Fähigkeiten oder Personen mit mangelnder Erfahrung und mangelnden Kenntnissen können dieses Gerät verwenden, soweit sie hierbei hinreichend überwacht werden, oder Anweisungen zur sicheren Verwendung des Geräts erhalten haben und damit verbundene Risiken berücksichtigt wurden. Kinder dürfen nicht mit dem Gerät spielen. Vom Benutzer durchführbare Reinigungs- und Wartungsmaßnahmen dürfen nicht ohne Überwachung von Kindern vorgenommen werden.

Dieses Gerät enthält das Kältegas R410A

Dieses Produkt enthält gemäß dem Kyoto-Protokoll Gase mit Treibhauseffekt. Setzen Sie diese Gase nicht in die Atmosphäre frei.

Höhe des Valeur GWP(1) : 2088 Wert basierend auf 4. GIEC-Bericht.

Die auf Grundlage der Vorschrift F Gas 517/2014 bestimmte Kältemittelmenge ist auf dem Typenschild des Geräts angegeben.

Jegliche Arbeiten am Kältekreislauf müssen, wie bereits oben gesagt, von einer zugelassenen Fachkraft ausgeführt werden.

Regelmäßige Inspektionen des Austritts von Kühlmittel können gemäß der europäischen Gesetzgebung oder der des jeweiligen Landes verlangt werden. Für weitere Informationen kontaktieren Sie bitte Ihren Händler vor Ort.

- Achtung, Kältemittel können geruchlos sein.
- Die Rohrleitung nicht durchbohren oder erhitzen. Dies kann zu Explosionen oder schweren Verbrennungen führen.
- Verwenden Sie zur Beschleunigung des Abtauens oder zur Reinigung ausschließlich die vom Hersteller empfohlenen Mittel.
- Ein Raum, in dem das Gerät aufbewahrt wird, darf keine permanent vorhandenen Zündquellen enthalten (zum Beispiel nackte Flammen, betriebene Gasgeräte oder Elektroheizungen).

(1) Möglichkeit der globalen Erwärmung

2. TECHNISCHE EIGENSCHAFTEN

2.1 Technische Angaben zur Heizpumpenanlage



Modell	ENERGYLINE PRO	ENP10TAS
Wärmeerzeugende Kapazität *	kW	36,9
Elektrische Antriebsleistung *	kW	6,87
Funktionsweise *	A	14,8
Versorgungsspannung	V / Ph / Hz	400 V / 3N~ / 50Hz
Sicherungsdurchmesser Typ aM	A	20
Leistungsschalter Kurve D	A	20
Kompressorennummer	/	1
Kompressortyp	/	Scroll
Anzahl der Gebläse	/	2
Stärke der Gebläse	W	50 - 225
Rotationsgeschwindigkeit der Ventilatoren	RPM	600 - 1050
Gebläse	/	Horizontal
Geräuschdruckpegel (bei 10 Meter) LpA	dB(A)	41
Hydraulikanschluss	mm	63
Nominaler Wasserdurchsatz*	m ³ /h	13
Verlust der Last auf dem Wasser (max.)	kPa	13,8
Reinmaße der Anlage (Länge/Breite/Höhe)	mm	1482 / 485 / 1480
Reingewicht der Einheit	kg	182

* Leistung entsprechend der Prüfnorm NF EN 14511, wiederaufgenommen im Bezugswerk NF-414.
Trockene Luft 15 °C - Relative Feuchtigkeit 71 % - Wassereingangstemperatur 26 °C.

2. TECHNISCHE EIGENSCHAFTEN (Fortsetzung)

2.2 Betriebsbereich

Benutzen Sie die Heizpumpenanlage innerhalb der folgenden Temperatur- und Luftfeuchtigkeitsbereichen, um ein sicheres und effizientes Funktionieren zu garantieren.

	Modus Erwärmen 	Modus Abkühlen 
Außentemperatur	-12°C ~ +35°C	+7°C ~ +43°C
Wassertemperatur	+12°C ~ +40°C	+8°C ~ +40°C
relative Luftfeuchtigkeit	< 80%	< 80%
Einstellbereich des Sollwerts	+15°C ~ +32°C	+8°C ~ +32°C



Wenn Temperatur oder Luftfeuchtigkeit nicht diesen Bedingungen entsprechen, können Sicherheitsmaßnahmen ausgelöst werden. Dann arbeitet die Heizpumpenanlage nicht mehr.



Die Höchsttemperatur für die Beheizung beträgt 32 °C, um eine Beschädigung der Verkleidung zu vermeiden. Hayward übernimmt keinerlei Verantwortung bei einer Verwendung über +32 °C.

2. TECHNISCHE EIGENSCHAFTEN (Fortsetzung)

2.3 Maße

Modell: ENP10TAS

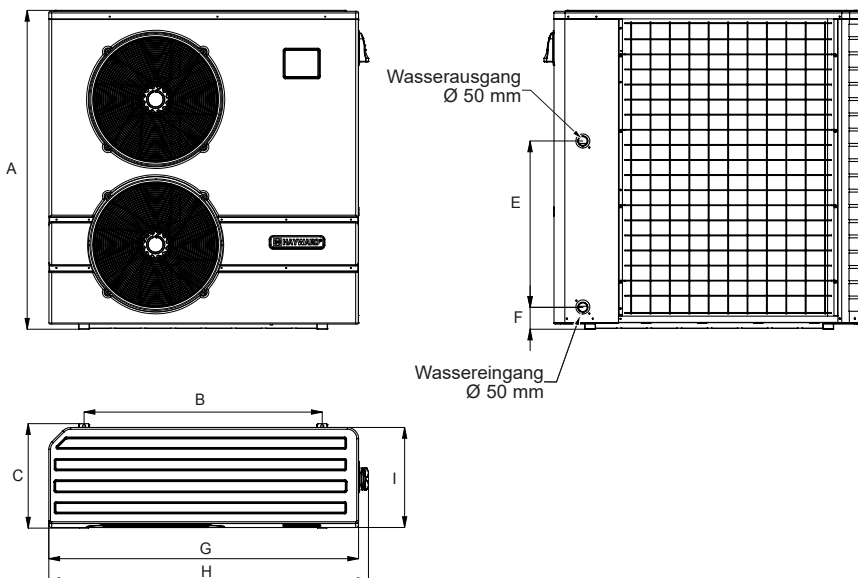

Anlage : mm

Modell	ENP10TAS
Markierung	
A	1480
B	1105
C	485
D	/
E	771,5
F	101,5
G	1437
H	1483
I	464

3. INSTALLATION UND ANSCHLUSS

3.1 Schematische Darstellung

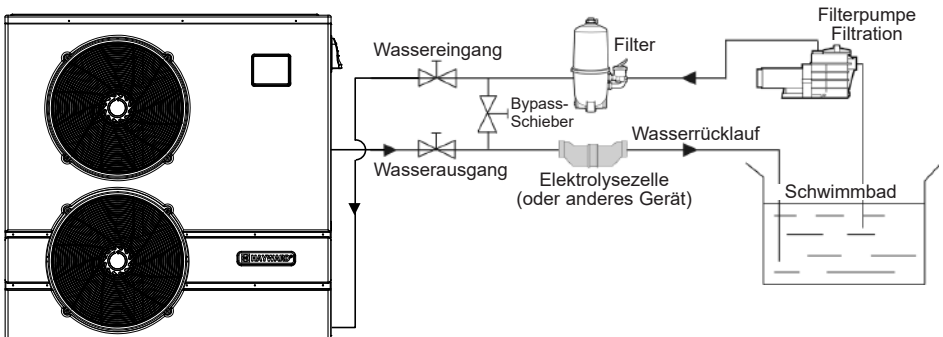

Anmerkung: Die Heizpumpenanlage verfügt über keinerlei Ausstattungs- oder Filtergerät. Die auf der Darstellung gezeigten Elemente werden vom Installateur bereitgestellt.

3.2 Heizpumpenanlage



Positionieren der Wärmepumpe im Außenbereich und außerhalb eines geschlossenen Technikraumes.

Platzieren Sie das Gerät möglichst an einer sonnenbeschienenen und gegen vorherrschende Winde geschützten Stelle.

Das Gerät muss für spätere Installations- und Wartungsarbeiten vollständig zugänglich bleiben.

In einem abgedeckten Bereich positionieren, die unten stehend vorgeschriebenen Mindestentfernungen müssen beachtet werden, damit das Risiko der Luft-Rezirkulation und allgemein eine Leistungsminderung der Wärmepumpe vermieden wird.

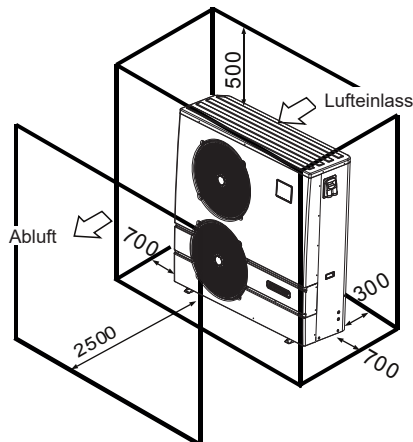

3. INSTALLATION UND ANSCHLÜSSE (Fortsetzung)



Stellen Sie das Gerät nicht direkt auf dem Boden ab, da dies zu Störungen führen kann.

Montieren Sie das Gerät zur Aufstellung auf dem Boden möglichst auf Vibrationsdämpfern.

Unter Bedingungen, bei denen Vibrationen übertragen werden können, darf das Gerät nicht an einer Wandbefestigung montiert werden.

Installieren Sie die Heizpumpe nicht auf einem Träger, der die Vibrationen des Geräts verstärken könnte.

Installieren Sie die Heizpumpe nicht an einem Ort, an dem ihr Schallpegel verstärkt oder die Nachbarschaft durch ihre Geräusche gestört werden könnte.

Verwenden Sie keine Klebstoffe. Solche gewährleisten keine zuverlässige Befestigung.

Installieren Sie das Wärmepumpensystem vorzugsweise auf einer ebenen, separaten Betonbodenplatte.

Stellen Sie das Wärmepumpensystem auf die mitgelieferten Silentblöcke (Schrauben und Unterlegscheiben werden mitgeliefert).

Befestigen Sie das Gerät mit den vorgeschriebenen Anziehdrehmomenten, um jegliche Gefahr von Unfällen mit Sach- und Personenschäden zu vermeiden.

Die Heizpumpe kann auch mit geeigneten Schraubelementen (nicht geliefert) auf Gummiuntersätzen am Boden befestigt werden.

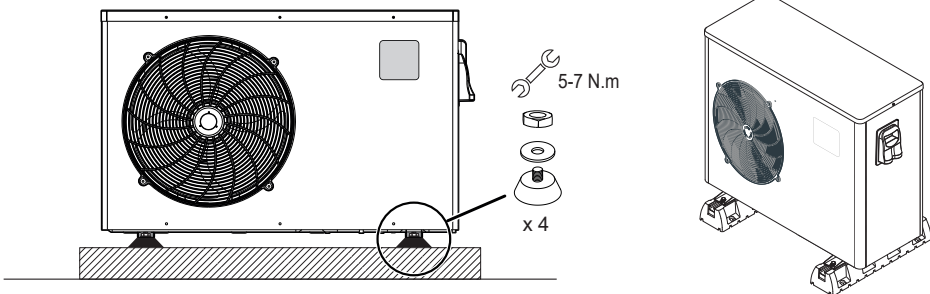

Maximale Entfernung zwischen Heizpumpenanlage und Schwimmbecken 15 Meter.

Gesamtlänge (hin und zurück) der hydraulischen Leitungen 30 Meter. Isolieren Sie sowohl die sichtbaren als auch die verdeckten hydraulischen Leitungen.

Die Wärmepumpe ist mit einem Mindestabstand vom Becken gemäß NF C 15-100 (d. h. für Frankreich 3,5 m entfernt von der Wasseroberfläche) oder gemäß den in den jeweiligen Ländern geltenden Installationsstandards zu installieren.

Die Wärmepumpe nicht in der Nähe einer Wärmequelle installieren.

Bei einer Installation in schneereichen Gebieten wird eine Abdeckung der Maschine empfohlen, um eine Schneeanhäufung auf dem Verdampfer zu verhindern.

3. INSTALLATION UND ANSCHLÜSSE (Fortsetzung)

3.3 Hydraulischer Anschluss

Die Heizpumpenanlage wird mit zwei Verbindungsstücken mit einem Durchmesser von 50 mm geliefert. Verwenden Sie PVC-Rohre mit 50 mm Durchmesser für das hydraulische Leitungsnetz. Schließen Sie die den Wassereinlass der Heizpumpenanlage an die Leitung der Filtergruppe an. Schließen Sie dann den Wasserausgang der Heizpumpenanlage an die Wasserleitung des Beckens an (s. Darstellung weiter unten).

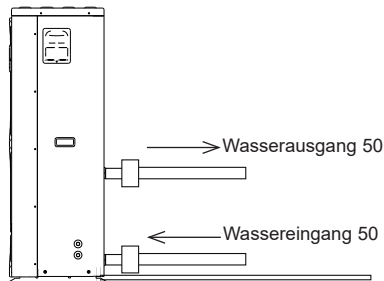

Installieren Sie einen Schieber, den so genannten "By-pass", zwischen den Eingang und den Ausgang der Heizpumpenanlage.



Wird ein automatischer Verteiler oder ein Elektrolyseur verwendet, muss dieser unbedingt nach der Heizpumpenanlage eingebaut werden, um so den Titan-Kondensator gegen eine zu hohe Konzentration chemischer Produkte zu schützen.



Achten Sie darauf, den By-pass-Schieber und die Verbindungsstücke am Ein- und Auslass der Anlage einzubauen, um den problemlosen Ablass der Anlage während der Wintermonate und einen einfacheren Zugang oder einen Abbau bei Wartungsarbeiten zu erleichtern.

3. INSTALLATION UND ANSCHLÜSSE (Fortsetzung)

3.4 Elektrischer Anschluss



Die Elektroinstallation und die Verkabelung dieses Gerätes müssen den geltenden Installationsvorschriften vor Ort entsprechen.

F	NF C15-100	GB	BS7671:1992
D	DIN VDE 0100-702	EW	EVHS-HD 384-7-702
A	ÖVE 8001-4-702	H	MSZ 2364-702/1994/MSZ 10-553 1/1990
E	UNE 20460-7-702 1993, RECBT ITC-BT-31 2002	M	MSA HD 384-7-702.S2
IRL	Wiring Rules (Richtlinien elektrischer Leitungen, Anm. d. Übers.) + IS HD 384-7-702	PL	PN-IEC 60364-7-702:1999
I	CEI 64-8/7	CZ	CSN 33 2000 7-702
LUX	384-7.702 S2	SK	STN 33 2000-7-702
NL	NEN 1010-7-702	SLO	SIST HD 384-7-702.S2
P	RSIUEE	TR	TS IEC 60364-7-702



Prüfen Sie, ob die verfügbare Stromversorgung und die Netzfrequenz den den erforderlichen Betriebsstrom entsprechen. Dabei müssen der jeweilige Standort des Gerätes und der erforderliche Strombedarf aller anderen, am gleichen Schaltkreis angeschlossener Geräte berücksichtigt werden.

ENP10TAS 400 V \sim +/- 10 % 50 Hz 3 Phasen



Überprüfen, dass das Gleichgewicht der Phasen 2 % nicht übersteigt.

Beachten Sie die schematische Darstellung der Verkabelung im Anhang. Die Anschlussbox befindet sich auf der rechten Seite der Anlage. Es gibt drei Anschlüsse für die Stromversorgung und zwei für die Steuerung der Filterpumpe (Nachlaufsteuerung).

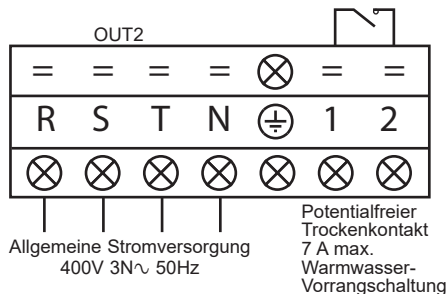

3. INSTALLATION UND ANSCHLUSS (Fortsetzung)



Schließen Sie das Gerät auf keinen Fall an einer Netzsteckdose an. Die Stromversorgungsleitung muss mit einem allpoligen Schutzgerät vom Typ D-Kurven-Schutzschalter sowie einem 30-mA-Differentialschutz-Schutzschalter ausgestattet sein (siehe nachfolgende Tafel).

Modell		ENP10TAS
Netzteil	V/Ph/Hz	400V 3N~ 50Hz
Sicherungsdurchmesser Typ aM	A	20 aM
Leistungsschalter Kurve D	A	20 D
Leitungsquerschnitt	mm ²	5G4 5 x 4



Ein Netzkabel vom Typ RO2V/R2V oder vergleichbar.



Die Leitungsquerschnitte werden für maximal 25 m Länge angegeben. Sie müssen gleichwohl überprüft und auf die Installationsbedingungen angepasst werden.



Achten Sie stets darauf, dass die Hauptstromversorgung abgeschaltet ist, bevor Sie den elektrischen Steuerkasten öffnen.

3.5 Erste Inbetriebnahme

Verfahren zur Inbetriebnahme - Nachdem Sie die Installation beendet haben, gehen Sie wie folgt vor:

- 1) Drehen Sie die Ventilatoren von Hand, um zu überprüfen, dass sie sich frei von Hand bewegen lassen und dass der Propeller korrekt auf der Antriebswelle befestigt ist.
- 2) Vergewissern Sie sich, dass die Einheit korrekt an die Hauptstromversorgung angeschlossen ist (siehe Schaltplan im Anhang).
- 3) Starten Sie die Filterpumpe.
- 4) Vergewissern Sie sich, dass alle Wasserein- und auslässe offen sind und dass das Wasser in die Anlage, bevor es erwärmt oder abgekühlt wird.
- 5) Vergewissern Sie sich, dass das Ablassrohr für das Kondensat ordnungsgemäß befestigt und frei von Blockaden ist.
- 6) Aktivieren Sie die Stromversorgung für die Anlage und drücken Sie dann den Start/Stop-Knopf  auf der Bedientafel.

3. INSTALLATION UND ANSCHLUSS (Fortsetzung)

- 7) Vergewissern Sie sich, dass kein ALARM-Code angezeigt wird, wenn die Anlage auf ON steht (siehe Anleitung zur Fehlerbehebung).
- 8) Arretieren Sie den Wasserdurchsatz mit dem By-pass-Schieber (s. § 3.6 und 2.1), wie für das jeweilige Modell vorgeschrieben, so dass eine Temperaturdifferenz zwischen Wasserein- und -ausgang von 2°C beibehalten wird.
- 9) Nachdem die Anlage einige Minuten in Betrieb ist, vergewissern Sie sich, dass die Luft, die aus der Anlage ausströmt, sich abgekühlt hat (um 5 bis 10°).
- 10) Ist die Anlage in Betrieb, schalten Sie die Filterpumpe ab. Die Anlage sollte sich automatisch abschalten und den Fehlercode E03 anzeigen.
- 11) Lassen sie die Anlage und die Schwimmbadpumpe 24 Stunden am Tag laufen, bis die gewünschte Wassertemperatur im Pool erreicht ist. Sobald das Eingangswasser die gewünschte Temperatur erreicht hat, schaltet sich die Anlage ab. Sie wird sich dann wieder automatisch einschalten (sofern die Schwimmbadpumpe in Betrieb ist), wenn die Temperatur des Schwimmbadwassers um mehr als 0,5°C von der eingestellten Temperatur abweicht.

Wasserdurchsatzregler - Die Anlage ist mit einem Regler für den Wasserdurchsatz ausgestattet, der diese einschaltet, wenn die Pumpe des Schwimmbadfilters in Betrieb ist und der diese ausschaltet, wenn die Filterpumpe außer Betrieb ist. Fehlt Wasser, so erscheint der Alarm-Code E03 auf dem Regler (siehe § 6.4).

Zeitliche Verzögerung - Die Anlage enthält eine zeitliche Verzögerung von 3 Minuten, welche die Komponenten des Steuerschaltkreises schützt und jegliche Instabilität bezüglich eines Neustarts sowie jegliche Störung im Bereich des Kontaktgebers verhindert. Aufgrund dieser zeitlichen Verzögerung startet die Anlage ca. 3 Minuten nach jeder Unterbrechung des Steuerschaltkreises automatisch neu. Selbst eine kurze Stromunterbrechung aktiviert diese zeitliche Verzögerung.

Phasenwächter - Die Dreiphaseneinheiten besitzen einen integrierten Phasenwächter, um die ordnungsgemäße Drehrichtung des Kompressors zu sichern. Falls die Einheit nicht anläuft, die Statusanzeige des im Schaltkasten befindlichen Phasenwächters kontrollieren.

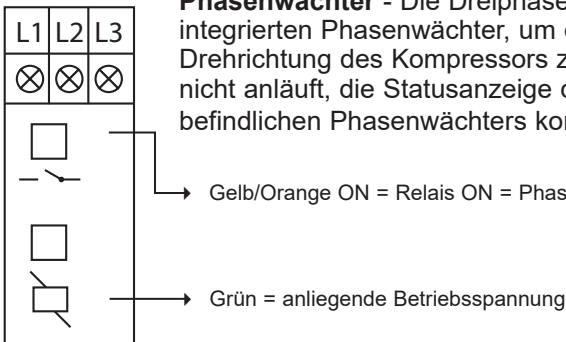

3. INSTALLATION UND ANSCHLUSS (Fortsetzung)

3.6 Einstellung des Wasserdurchsatzes

Stellen Sie den so genannten By-pass-Schieber bei geöffneten Wassereinlass- und -auslassschiebern so ein, dass eine Unterschied von 2°C zwischen der Wassereingangs- und der Wasserausgangstemperatur erreicht wird (siehe Schematische Darstellung § 3.1). Sie können die Einstellung der Eingangs- und Ausgangstemperaturen direkt auf der Bedientafel kontrollieren.

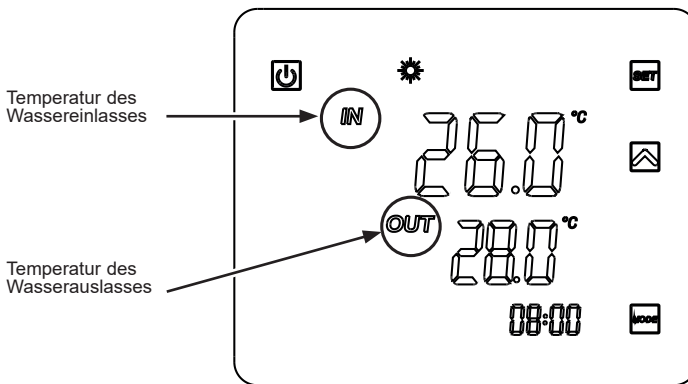

Anmerkung: Das Öffnen des By-pass-Schiebers führt zu einem geringeren Durchsatz oder zu einer Zunahme des ΔT .
Das Schließen des By-pass-Schiebers führt zu einem höheren Durchsatz oder zu einer Verringerung des ΔT .

4. BENUTZEROBERFLÄCHE

4.1 Allgemeine Darstellung

Die Heizpumpenanlage ist mit einem digitalen Touchscreen-Bedienfeld ausgestattet, elektronisch angeschlossen und werksseitig auf Heizmodus voreingestellt.

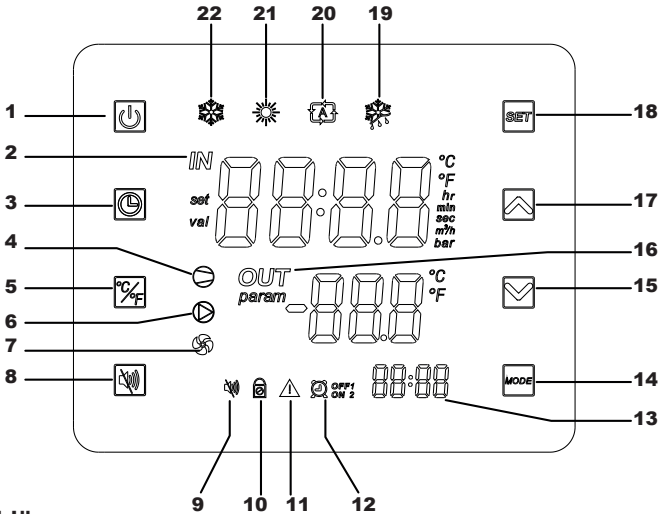

Zeichenerklärung

1		Start/Stopp
2		Wassereinlass
3		Uhrzeit- und Timereinstellung
4		Kompressor ON
5		Umstellung °C/°F
6		Trockenkontakt OUT2
7		Fan ON
8		Ruhemodus
9		Kontrollleuchte Ruhemodus
10		Bildschirm gesperrt
11		Alarm

12		Timers 1 und 2
13		Uhrzeit für die Timer
14		Modus-Auswahl
15		Nach unten scrollen / Verringern
16		Wasserauslass
17		Nach oben scrollen / Erhöhen
18		Sicherung / Einstellungen
19		Abtauenmodus
20		Automatikmodus
21		Heizmodus
22		Kühlmodus

4. BENUTZEROBERFLÄCHE (Fortsetzung)

Modus OFF

Befindet sich die Heizpumpenanlage im Stand-by-Modus (Modus OFF), erscheint im Bedienfeld die Anzeige "OFF".

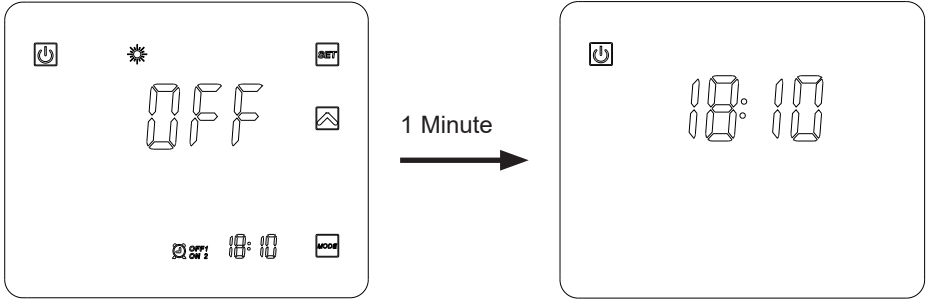

Modus ON

Befindet sich die Heizpumpenanlage in Betrieb oder in der Regulierung (Modus ON), so erscheinen die Temperaturen des eintretenden und des austretenden Wassers im Bedienfeld.

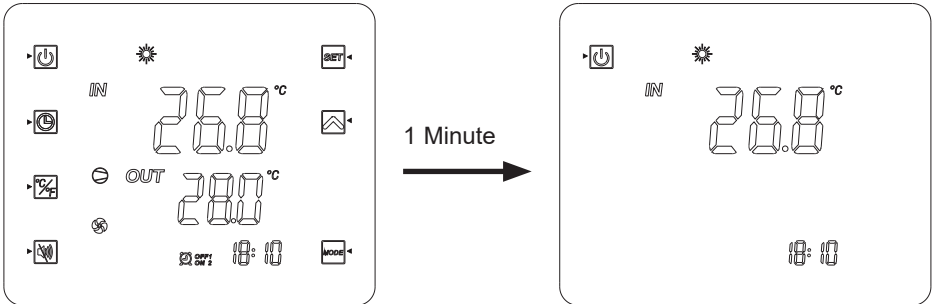









4. BENUTZEROBERFLÄCHE (Fortsetzung)

Am Ende der Einstellungen, drücken Sie , um zu bestätigen.
Aufnahme-Einstellungen automatisch nach 20s ohne Aktion.

4.2 Einstellung der Uhr









Wenn das Display im Standby-Modus ist, drücken Sie kurz auf die Taste .

- 1) Drücken Sie auf  damit das Symbol  erscheint.
- 2) Drücken Sie auf , die Stundenanzeige blinkt. Stellen Sie die Stunden mit den Tasten   ein.
- 3) Drücken Sie auf  und stellen Sie dann die Minuten mit den Tasten   ein.
- 4) Drücken Sie auf  zur Bestätigung.











4.3 Einstellung der Timer-Funktion



Die Einstellung dieser Funktion ist notwendig, wenn Sie die Heizpumpenanlage über einen kürzeren als den von der Filteruhr vorgegebenen Zeitraum betreiben möchten. Damit können Sie einen zeitlich versetzten Beginn oder ein vorzeitiges Ende programmieren bzw. einen Teilbereich des Betriebszeitplans unterbinden (zum Beispiel nachts). Sie können 2 Start-Timer (ON1 und ON2) und 2 Stopp-Timer (OFF1 und OFF2) programmieren.

Programmierung des Timers 1 – Start

- 1) Drücken Sie auf  für 2s, der Timer ON1  blinkt (*).
- 2) Drücken Sie auf . Stellen Sie die Stunden mit den Tasten   ein.
- 3) Drücken Sie auf . Stellen Sie die Minuten mit den Tasten   ein.
- 4) Drücken Sie auf  zur Bestätigung.



Abschalten des Timers 1 – Stopp

- 1) Drücken Sie auf  für 2s, der Timer ON1  blinkt (*).
Drücken Sie auf einmal , der Timer OFF1  blinkt.
- 2) Drücken Sie auf . Stellen Sie die Stunden mit den Tasten   ein.
- 3) Drücken Sie auf . Stellen Sie die Minuten mit den Tasten   ein.
- 4) Drücken Sie auf  zur Bestätigung.



(*) Um direkt Timer ON2  aufzurufen, drücken Sie 2s lang auf  und drücken Sie dann 2 Mal auf .

4. BENUTZEROBERFLÄCHE (Fortsetzung)

















Abschalten des Timers 2

Nach den Einstellungen für Timer 1 gelangen Sie direkt zu den Einstellungen für Timer 2:  und .

Gehen Sie gleich vor wie bei Timer 1.

Nota: Um direkt Timer ON2  aufzurufen, drücken Sie 2s lang auf  und drücken Sie dann 2 Mal auf .

Löschen der Timers (Start und Stopp)

- 1) Drücken Sie auf  für 2s, der Timer ON1  blinkt (*).
 - 2) Drücken Sie auf  , die Uhrzeitanzeige blinkt.
 - 3) Drücken Sie auf  , um den Timer  zu löschen.
 - 4) Drücken Sie auf  zur Bestätigung.
 - 5) Drücken Sie auf  für 2s, der Timer ON1  blinkt.
Drücken Sie 1 Mal auf  , der Timer  blinkt.(*).
 - 6) Drücken Sie auf  , die Uhrzeitanzeige blinkt.
 - 7) Drücken Sie auf  , um den Timer  zu löschen.
- (*) Um direkt Timer2  oder  aufzurufen, befolgen Sie Schritt 1)- 4) und drücken Sie dann 2 Mal auf  . Gehen Sie gleich vor wie oben.

4.4 Wahl des Funktionsmodus

Im Modus “OFF” oder “ON”

Drücken Sie auf  , um den Modus zu wechseln: Kühlung, Heizung oder Auto.

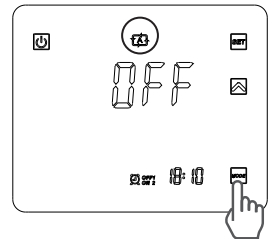
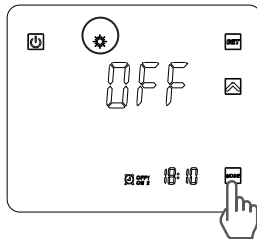
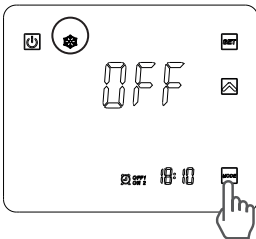



Wenn die Wärmepumpe in nur Heizen oder nur Kühlen Modus eingestellt ist, ist die Modusänderung nicht möglich.

4. BENUTZEROBERFLÄCHE (Fortsetzung)

4.5 Einstellung und Anzeige des Sollwerts



(gewünschte Wassertemperatur)

Wenn die Taste  nicht auf dem Bildschirm angezeigt wird, drücken Sie kurz auf .

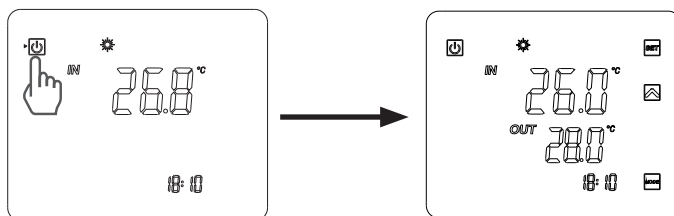
(Sowohl während des Betriebs als auch in ausgeschaltetem Zustand können Sie einfach auf die Taste  drücken, damit der Sollwert angezeigt wird.)





Im Modus “OFF” und im Modus “ON”



Drücken Sie die Knöpfe , damit der Sollwert angezeigt wird, und drücken Sie dann auf  oder  um den gewünschten Sollwert festzulegen. Die Einstellung erfolgt mit einer Präzision von 0,5 °C.



Es wird empfohlen, niemals eine Temperatur von 30°C zu überschreiten, um Veränderungen der Auskleidungen zu vermeiden

4.6 Sperren und Entsperren des Touchscreen

Drücken Sie 5 Sekunden lang den Knopf Start/Stop , bis Sie einen Piepton hören und die Symbole erscheinen .

Um den Touchscreen zu entsperren, drücken Sie  5 Sekunden lang den Knopf, bis Sie einen Piepton hören und die Symbole verschwinden .

4. BENUTZEROBERFLÄCHE (Fortsetzung)

4.7 Einstellen des Ruhemodus



Mit dieser Funktion können die Ventilatoren der Wärmepumpe maximal 8 Stunden lang mit einer reduzierten Rotationsgeschwindigkeit von 600 U/min betrieben werden, um je nach Aufstellungsort der Wärmepumpe nachts und/oder tagsüber Lärmbelästigung der Nachbarn und/oder im Becken zu vermeiden. Diese Funktion kann entweder manuell oder über eine Zeitschaltung Aktiviert/Deaktiviert werden.

Manuelle Aktivierung

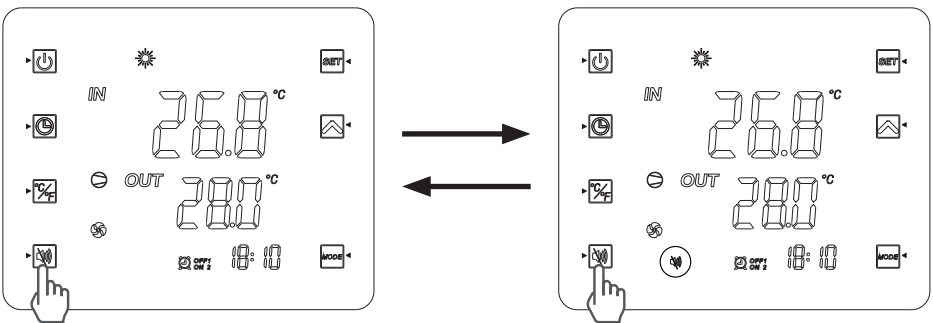
- 1) Drücken Sie die Taste .
- 2) Die nachfolgende Anzeige erscheint auf dem Bildschirm, der Ruhemodus ist für die folgenden 8 Stunden aktiviert.
- 3) Die Rotationsgeschwindigkeit der Ventilatoren wird schrittweise und für eine Dauer von maximal 8 Stunden herabgesetzt.
- 4) Nach 8 Stunden wird die Funktion automatisch deaktiviert und die Ventilatoren werden wieder mit einer an die Umgebungstemperatur angepassten Rotationsgeschwindigkeit betrieben.





Manuelle Deaktivierung

- 1) Drücken Sie die Taste .
- 2) Die Kontrollleuchte  verschwindet vom Bildschirm: Der Ruhemodus ist deaktiviert.
- 3) Die Ventilatoren passen ihre Rotationsgeschwindigkeit der Außenlufttemperatur an.

4. BENUTZEROBERFLÄCHE (Fortsetzung)



Programmieren des RUHE-Modus

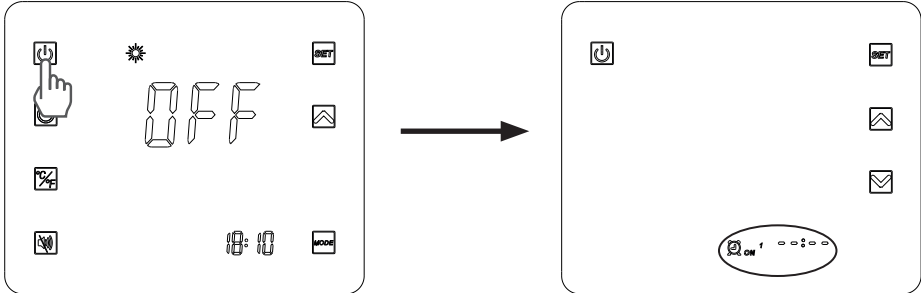

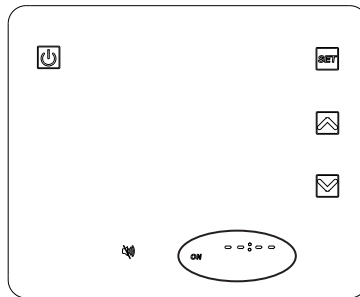

1) Drücken Sie auf  für 2s, der Timer ON1  ON¹ blinkt.



2) Drücken Sie 4 Mal auf , bis der nachfolgende Bildschirm erscheint.









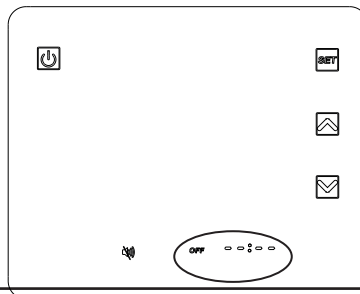

3) Drücken Sie auf , die Stundenanzeige blinkt. Stellen Sie mit den Pfeilen   die Stunden für die Startzeit ein.

4) Drücken Sie auf , die Minutenanzeige blinkt. Stellen Sie mit den Pfeilen   die Minuten für die Startzeit ein.
Drücken Sie zur Bestätigung auf .

5) Drücken Sie auf  um die Endzeit einzustellen: Die Anzeige OFF blinkt.



4. BENUTZEROBERFLÄCHE (Fortsetzung)

- 6) Drücken Sie auf , die Stundenanzeige blinkt. Stellen Sie mit den Pfeilen   die Stunden für die Endzeit ein.
- 7) Drücken Sie auf , die Minutenanzeige blinkt. Stellen Sie mit den Pfeilen   die Minuten für die Endzeit ein. Drücken Sie  zur Bestätigung auf.
- 8) Drücken Sie auf  um zum vorherigen Bildschirm zurückzukehren. Die Anzeigen ON/OFF erscheinen wie unten dargestellt.

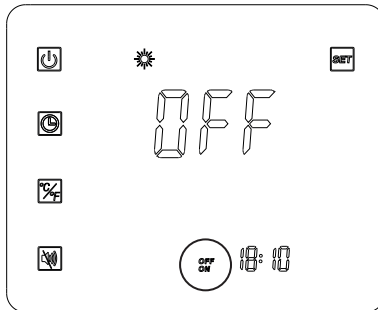

Nota : Die Einstellung der Minuten findet in Schritten von 10 Minuten statt.

Nach erfolgter Einstellung des SILENCE-Modus ist dieser standardmäßig 7 Tage pro Woche aktiviert.

5. WARTUNG UND WINTERZEIT

5.1 Wartung

Diese Maßregeln zur Wartung müssen ein Mal pro Jahr durchgeführt werden, um die Langlebigkeit und gute Funktionsweise der Heizpumpenanlage zu garantieren.

- Wartung und Reparaturen des Geräts müssen von einer technischen Fachkraft durchgeführt werden, die nach den im Land, in dem das Gerät installiert ist, geltenden Bestimmungen zugelassen ist (s. § 3.4). Fachkräfte, die irgendwelche Arbeiten am Kältekreislauf durchführen, müssen ihre Befähigung zum Umgang mit Kältemitteln nachweisen können.
- Das Netzkabel prüfen. Ist das Netzkabel beschädigt, so muss es vom Hersteller, dessen Kundendienst oder einer hierzu befähigten und zugelassenen Person ersetzt werden.
- Den Erdungsanschluss des Geräts und die Durchgängigkeit des Erdungsleiters prüfen.
- Reinigen Sie den Evaporator mit Hilfe einer flexiblen Bürste, einem Luft- oder einem Wasserstrahl (**Achtung: Verwenden Sie niemals einen Hochdruckreiniger**).
- Kontrollieren Sie den korrekten Abfluss des Kondensats.
- Kontrollieren Sie die hydraulischen und elektrischen Anschlüsse.
- Kontrollieren Sie die hydraulische Dichtigkeit des Kondensator.
- Die Dichtheit des Kältekreislaufs mithilfe eines Leckdetektors **durch eine autorisierte Fachkraft** prüfen lassen.



Vor allen Wartungsmaßnahmen muss die Heizpumpenanlage von jeglicher Stromversorgung getrennt werden. Die Wartungsmaßnahmen müssen von einem qualifizierten Fachmann durchgeführt werden, dem der Umgang mit Kühlflüssigkeiten vertraut ist.

5.2 Winterzeit

- Stellen Sie die Heizpumpenanlage auf den Modus "OFF".
- Trennen Sie die Heizpumpenanlage von der Stromversorgung.
- Leeren Sie den Kondensator mit Hilfe des Wasserablassers, um jegliche Schadensgefahr zu vermeiden. (großes Frostrisiko).
- Schließen Sie den By-pass-Schieber und lösen Sie die Eingangs- und Ausgangsverbindungsstücke.
- Entfernen Sie so gut es geht das Altwasser im Kondensator mit Hilfe einer Druckluftpistole.
- Verschließen Sie den Wasserein- und -ausgang an der Heizpumpenanlage, um das Eindringen von Fremdkörpern zu verhindern.
- Decken Sie die Heizpumpenanlage mit der für diesen Zweck vorgesehenen Winterschutzhülle ab.



Jeglicher Schaden, der durch eine schlechte Winterlagerung entsteht, hebt alle Garantieansprüche auf.

6. ANHANG

6.1 Elektrischen Schema

ENP10TAS

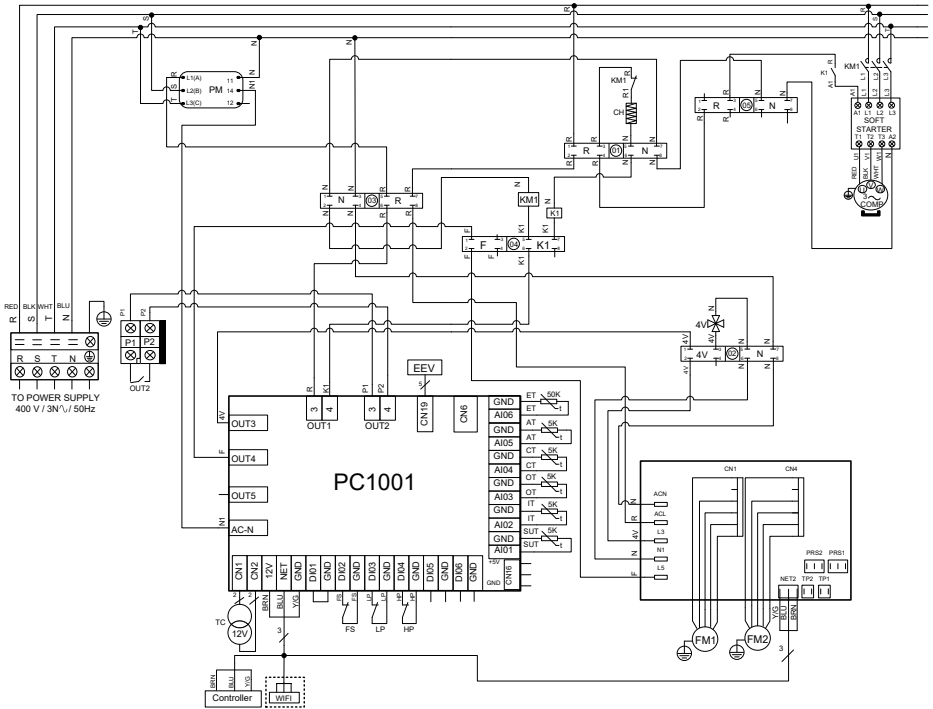

ANMERKUNGEN:

- AT : AUSSENTEMPERSENSOR
- COMP : KOMPRESSOR
- CT : TEMPERATURSENSOR DES EVAPORATORS
- EEV : ELEKTRONISCHER SENSOR
- FM1-2 : GEBLÄSEMOTOR
- FS : SENSOR DES WASSERSTANDES
- HP : HOCHDRUCKREGLER
- IT : SENSOR DER TEMPERATUR DES WASSEREINLASSES
- LP : NIEDRIGDRUCKREGLER

- OT : SENSOR DER TEMPERATUR DES WASSERAUSLASSES
- SUT : SENSOR DER SAUGTEMPERATUR
- TC : TRANSFORMATOR 230V~/ 12V~
- 4V : 4-WEGE-VENTIL
- KM1 : LEISTUNGSSCHÜTZ KOMPRESSOR
- PM : PHASENWÄCHTER
- CH1 : TRAGFÄHIGKEIT DES GEHÄUSES
- ET : DRUCKTEMPERATURSONDE
- OUT2 : POTENTIALFREIER TROCKENKONTAKT MAX. 7 A
- ⋮ : OPTION

6. ANHANG (Fortsetzung)

6.2 Vorrangige Heizanschlüsse dreiphasige Pumpe

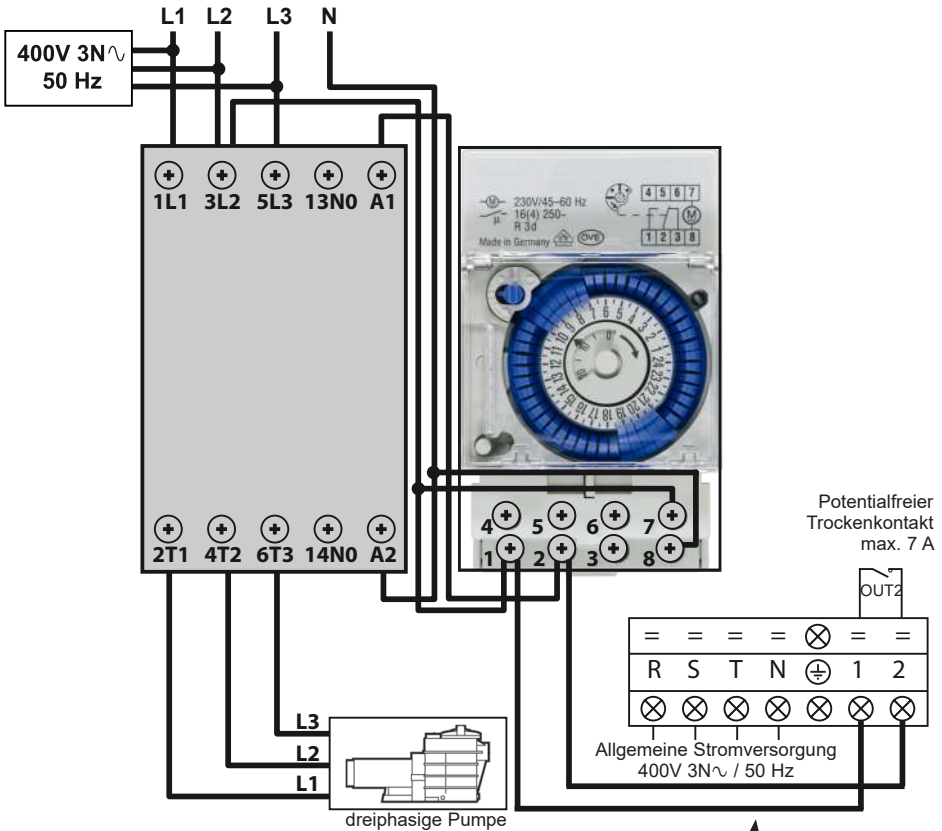

Die Anschlüsse 1 und 2 liefern einen potenzialfreien Trockenkontakt ohne Polarität 230 V \sim / 50 Hz. Verkabeln Sie die Anschlüsse 1 und 2 unter Berücksichtigung des folgenden Kabelschemas, um die Filtrationspumpe jede Stunde in einem 2-Minuten-Zyklus zu aktivieren, wenn die Temperatur des Beckens unter den Sollwert fällt.

 Die Stromversorgung der Filtrationspumpe niemals direkt an die Anschlüsse 1 und 2 anschließen.



Seite bewusst leer gelassen

6. ANHANG (Fortsetzung)

6.3 Explosionszeichnungen und Einzelteile

ENP10TAS

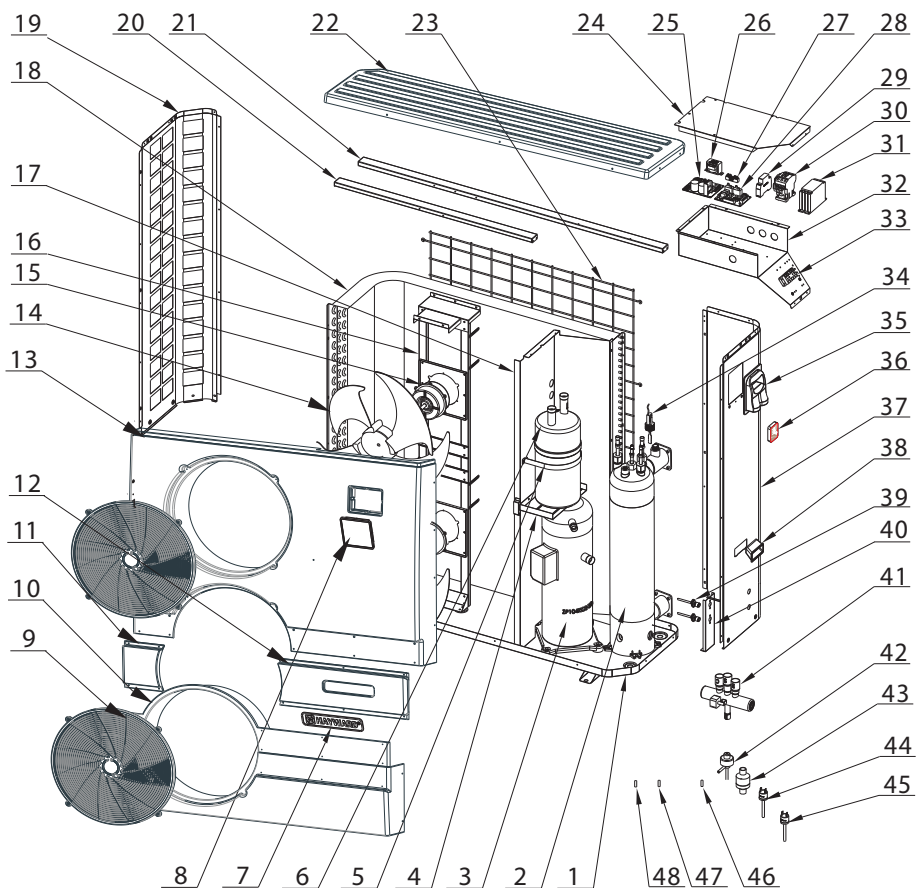

6. ANHANG (Fortsetzung)

ENP10TAS

Nr.	Ref.	Bezeichnung	Nr.	Ref.	Bezeichnung
1	HWX32005210049	Boden	27	HWX20003909	Klemmleiste mit 2 Anschlüssen
2	HWX32005120009	Titan/PVC--Kondensator	28	HWX950531014516	Elektronikkarte
3	HWX20000110153	Kompressor	29	HWX200036023	Phasenregler
4	HWX32027210011	Flüssigkeitstankhalterung	30	HWX20000360209	Dreiphasen-Kompressor-Impulsgeber
5	HWX32027210013	Schlauchselle	31	HWX20000360092	Elektronischer Anlasser TRI
6	HWX35141402	Flüssigkeitstank	32	HWX32005210054	Schaltkasten
7	HWX20000230596	Hayward-Logo	33	HWX20000390180	Klemmleiste mit 5 Anschlüssen
8	HWX95005010018	LED-Regler	34	HWX200036005	Sensor des Wasserdurchsatzes
9	HWX32020220001	Schutzgitter des Gebläses	35	HWX32009220032	Stromanschlussklappe
10	HWX32005220002	Untere Frontplatte	36	HWX95005010014	WLAN-Modul
11	HWX32005220005	Dekorative Platte links	37	HWX32005210060	Rechtes Schild
12	HWX32005220004	Dekorative Platte rechts	38	HWX32008220037	Handgriff
13	HWX32005220001	Obere Frontplatte	39	HWX20000140353	Druckabzweigung HD&ND
14	HWX20000270025	Gebläsepropeller	40	HWX32019210038	Trägerplatte Hochdruck-/Niederdruckanschluss
15	HWX20000330361	DC-Motor	41	HWX20011488	4-Wege-Ventil
16	HWX32005210058	Motorträger	42	HWX20000140338	Elektronischer Sensor
17	HWX32005210065	Trennungsschild	43	HWX20041455	Filter
18	HWX32005120008	Verdunster	44	HWX20003603	Druckregler Niederdruck
19	HWX32005210051	Linkes Schild	45	HWX20013605	Druckregler Hochdruck
20	HWX32005220055	Kurze Versteifung	46/47	HWX20003242	Temperatursensor Evaporators/Luft/Wasser
21	HWX32005210056	Lange Versteifung	48	HWX20003223	Kompressorsensor 50 kΩ
22	HWX32005220003	Obere Platte	*49*	HWX20000240208	Winterabdeckung
23	HWX32005210063	Schutzabdeckung für Verdampfer	*50*	HWX200026009	O-Ring ID 48-SD 5 mm
24	HWX32005210053	Stromschutzplatte	*51*	HWX200026061	O-Ring ID 43-SD 3,4 mm
25	HWX950531024107	DC-Wandler-Modul	*52*	HWX20003214	Kurbelgehäuseheizung
26	HWX200037003	Transformator 230V~ - 12V~	*53*	HWX20002625	Schwingungsdämpfer

Anmerkung: Die Markierungen *xx* sind nicht in der entsprechenden Explosionsdarstellung eingezeichnet.

6. ANHANG (Fortsetzung)



6.4 Anleitung zur Fehlerbehebung

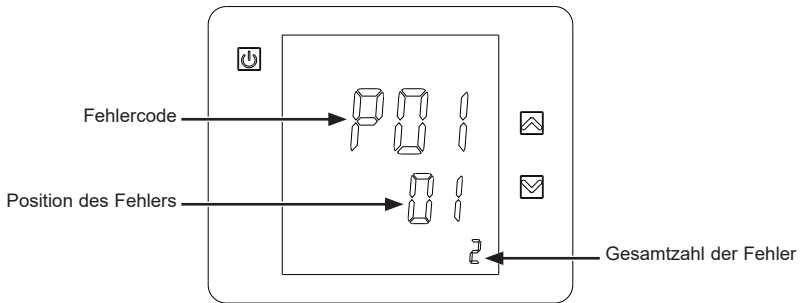

Manche Maßnahmen müssen von einem mit der Anlage vertrauten Techniker durchgeführt werden.

Im Falle einer Störung erscheinen die folgenden Anzeigen auf dem Bildschirm:



Sollten mehrere Störungen vorliegen, drücken Sie auf  oder , um durch die Fehlercodes zu navigieren. Siehe nachfolgende Tabelle.

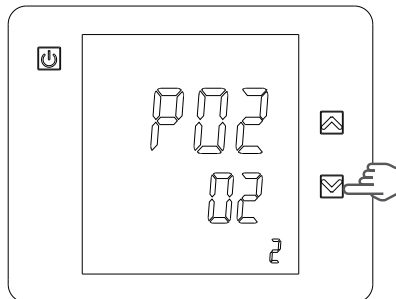

6. ANHANG (Fortsetzung)

Störung	Fehlercode	Beschreibung	Lösung
Ausfall des Sensors des Wassereinlasses	P01	Der Sensor ist offen oder hat einen Kurzschluss.	Überprüfen Sie den Sensor oder tauschen Sie ihn aus.
Ausfall des Sensors des Wasserauslasses	P02	Der Sensor ist offen oder hat einen Kurzschluss.	Überprüfen Sie den Sensor oder tauschen Sie ihn aus.
Ausfall des Magnetspulensensors	P05	Der Sensor ist offen oder hat einen Kurzschluss.	Überprüfen Sie den Sensor oder tauschen Sie ihn aus.
Ausfall des Außentemperatursensors	P04	Der Sensor ist offen oder hat einen Kurzschluss.	Überprüfen Sie den Sensor oder tauschen Sie ihn aus.
Fehler an der Saugsonde des Kompressors	P07	Der Sensor ist offen oder hat einen Kurzschluss.	Überprüfen Sie den Sensor oder tauschen Sie ihn aus.
Temperaturunterschied zwischen Wasserein- und Wasserauslass ist zu groß	E06	Nicht ausreichendes Volumen des Wasserdurchsatzes, Wasserdifferenz ist zu klein / zu groß.	Überprüfen Sie den Wasserdurchsatz bzw. eine mögliche Verstopfung des Systems.
Frostschutz Frostmodus	E07	Zu geringer Wasserauslass	Überprüfen Sie den Wasserdurchsatz bzw. den Temperatursensor des Wasserauslasses
Frostschutz auf Niveau 1	E19	Außen- oder Wassereinlasstemperatur zu niedrig	
Frostschutz auf Niveau 2	E29	Außen- oder Wassereinlasstemperatur noch immer zu niedrig.	
Hochdruckregler	E01	Der Druck des Kühlkreislaufs ist zu hoch bzw. der Wasserdurchsatz zu gering bzw. der Luftdurchsatz ist zu gering.	Überprüfen Sie den Hochdruckregler und den Druck des Kühlkreislaufs. Überprüfen Sie den Wasser- oder Luftdurchsatz. Überprüfen Sie die Funktion der Durchflusskontrolle. Überprüfen Sie die Öffnung des Wassereingang-/ausgangsschiebers. Überprüfen Sie die Regulierung des By-pass.
Niedrigdruckregler	E02	Der Druck des Kühlkreislaufs ist zu schwach bzw. der Luftdurchsatz ist zu schwach bzw. der Evaporator ist verstopft.	Überprüfen Sie den Niederdruckregler und den Druck des Kühlkreislaufs, um zu überprüfen, ob es eine undichte Stelle gibt. Reinigen Sie die Oberfläche des Evaporators. Überprüfen Sie die Rotationsgeschwindigkeit des Gebläses. Überprüfen Sie die freie Luftzirkulation mit Hilfe des Evaporators.
Ausfall des Durchsatzsensors	E03	Wasserdurchsatz unzureichend bzw. Fehler oder Kurzschluss des Sensors	Überprüfen Sie den Wasserdurchsatz, überprüfen Sie die Filterpumpe und den Durchsatzsensor, um festzustellen, ob eventuell eine Störung vorliegt.
Kommunikationsproblem	E08	Ausfall der LED-Steuerung oder des PCB-Anschlusses.	Überprüfen Sie die Verbindung der Kabel NET und NET 1.
Der Kompressor läuft nicht an	E08	Phasenausfall oder falsche Phasenfolge	das Vorhandensein aller 3 Phasen kontrollieren die Reihenfolge der Phasen auf der Anschlussklemme der Wärmepumpe ändern

6. ANHANG (Fortsetzung)

6.5 Garantie

GARANTIEVORAUSSETZUNGEN

Für sämtliche HAYWARD-Produkte bestehen innerhalb von zwei Jahren ab Kauf des Produkts Garantien hinsichtlich sämtlicher Fertigungsfehler oder Materialmängel. Bei jedem Antrag auf Garantie muss der Nachweis des Kaufs, einschließlich des Belegs zum Kaufdatum, erbracht werden. Wir bitten Sie also um Aufbewahrung Ihrer Rechnung.

Die HAYWARD-Garantie, die grundsätzlich ganz im Ermessen von HAYWARD liegt, beschränkt sich auf die Reparatur oder den Ersatz, hinsichtlich fehlerhafter Produkte, sofern sie sachgemäß benutzt wurden, nämlich in Übereinstimmung mit den im Benutzerleitfaden befindlichen Vorschriften; das Produkt darf keinesfalls verändert worden sein und darf ausschließlich mit den Bauteilen und Einzelteilen von HAYWARD benutzt werden. Die Garantie erstreckt sich nicht auf Beschädigungen aufgrund von Frost und Einwirkungen chemischer Substanzen.

Ausgeschlossen von der Garantie sind sämtliche sonstigen Kosten (Transport, Arbeitstätigkeit...).

HAYWARD kann nicht haftbar gemacht werden für direkte oder indirekte Schäden, die sich aufgrund falscher Montage, fehlerhaften Anschlusses oder der falschen Funktion des Produkts ergeben.

Falls Sie einen Garantieantrag stellen, eine Reparatur beantragen oder ein Produkt austauschen möchten, so wenden Sie sich bitte an Ihren Händler. Ausgeschlossen ist eine Material-Rücksendung an unser Werk ist ohne unsere vorherige schriftliche Zustimmung.

Die Verschleißteile unterliegen nicht der Garantie.

6.6 Entsorgung des ausgedienten Geräts



Die Kennzeichnung von Elektro- und Elektronikgeräten durch eine durchgestrichene Mülltonne weist darauf hin, dass diese Geräte nicht in normalem Hausmüll, Sperrmüll oder auf Mülldeponien entsorgt werden dürfen.

 Hat das Gerät sein Lebensende erreicht, so ist es in Hinblick auf Recycling oder Verwertung einer getrennten Abfallsammlung zuzuführen. In den Ländern der Europäischen Union und in Norwegen ist ein spezielles Abfallsammelsystem für Geräte dieser Art eingerichtet.

Zum Einsammeln, Zerlegen und Recycling dieses Geräts treten Sie bitte mit der Firma, die es installiert hat, oder der örtlichen Vertretung in Verbindung.

Die Aufbereitung des Kältemittels, des Öls und anderer Teile muss von einer hierzu nach geltenden lokalen und nationalen Vorschriften zugelassenen Fachkraft vorgenommen werden. Enthält das Gerät Batterien, die mit diesem Symbol gekennzeichnet sind, so können diese schädliche oder verschmutzende Stoffe enthalten. Die Batterien sind in diesem Fall bei einer Sammelstelle für verbrauchte Batterien abzugeben.

ENERGYLINE PRO

ZWEMBAD WARMTEPOMP



ENP10TAS

Installatie- en bedieningshandleiding

INHOUD

1. ALGEMENE INSTRUCTIES - VEILIGHEID	1
2. TECHNISCHE EIGENSCHAPPEN	4
2.1 Technische gegevens over de warmtepomp	4
2.2 Werkgebied	5
2.3 Afmetingen	6
3. INSTALLATIE EN AANSLUITING	7
3.1 Basisschema	7
3.2 Warmtepomp	7
3.3 Hydraulische aansluiting	9
3.4 Elektrische aansluiting	10
3.5 Eerste gebruik	11
3.6 Instelling van het waterdebiet	13
4. GEBRUIKERSINTERFACE	14
4.1 Algemene voorstelling	14
4.2 De klok instellen	16
4.3 De Timer instellen	16
4.4 Gebruiksmodus	17
4.5 Instelbereik en visualisatie van de gewenste waarde	18
4.6 Het touchscreen vergrendelen en ontgrendelen	18
4.7 Instelling van de silence modus	19
5. ONDERHOUD EN OVERWINTERING	22
5.1 Onderhoud	22
5.2 Overwintering	22
6. BIJLAGEN	23
6.1 Elektrische schema	23
6.2 Aansluitingen prioriteit verwarming driefasenpomp	24
6.3 Opengewerkte tekeningen en onderdelen	26
6.4 Gids voor het probleemoplossing	28
6.5 Garantie	30
6.6 Einde levensduur van het toestel	30

Aandachtig lezen en bewaren voor later gebruik.

Dit document moet aan de eigenaar van het zwebad overhandigd en door hem op een veilige plaats bewaard worden.

1. ALGEMENE INSTRUCTIES - VEILIGHEID

Wij danken u voor uw aankoop van deze zwembad Hayward warmtepomp. Dit product werd ontworpen volgens strikte productienormen om aan het vereiste kwaliteitsniveau te voldoen. Deze handleiding bevat alle noodzakelijke informatie over de installatie, het oplossen van problemen en het onderhoud. Lees deze handleiding aandachtig vooraleer u de eenheid opent of er onderhoudsoperaties op uitvoert. De producent van dit product zal in geen geval aansprakelijk zijn in geval van verwonding van een gebruiker of beschadiging van de eenheid ten gevolge van fouten tijdens de installatie, het oplossen van problemen of een onnodig onderhoud. Het is van het grootste belang om de instructies die in deze handleiding gegeven worden op elk ogenblik te volgen.

Nadat u deze handleiding gelezen hebt, bewaar deze dan voor eventueel later gebruik.

Bevoegd personeel

- De installatie, de elektrische aansluitingen, het onderhoud en de reparaties van het toestel moeten worden uitgevoerd door een erkend vakman overeenkomstig de voorschriften en beste praktijken die gelden in het land waar het toestel wordt geïnstalleerd (zie § 3.4).
Voor elke interventie op het koelcircuit moet de installateur beschikken over een certificaat van bekwaamheid om met koelmiddelen om te gaan.
Voor Frankrijk:
 - Laagspanningsinstallatie volgens NF-C 15-100.
 - Wetgeving inzake de behandeling van koelmiddelen: Besluit 2007/737 en de uitvoeringsbesluiten daarvan.

Voorwaarden voor installatie

- Probeer dit toestel niet zelf te installeren.
- Dit product is uitsluitend ontworpen voor huiselijk gebruik en installatie buitenshuis. De lucht die uit het product ontsnapt, moet vrij kunnen stromen en mag niet worden gebruikt voor andere doeleinden, zoals het verwarmen of koelen van een ruimte of gebouw.
- Deze warmtepomp verwarmt het zwembadwater en houdt de temperatuur constant. Gebruik hem niet voor andere doeleinden.
- Controleer de voedingskabel. Als de voedingskabel beschadigd is, moet deze worden vervangen door de fabrikant, zijn servicedienst of een bevoegd persoon.

1. ALGEMENE INSTRUCTIES - VEILIGHEID (vervolg)

- De aansluiting van het apparaat op de aarde en de continuïteit ervan zijn verplicht. De aardingskabel moet langer zijn dan de andere kabels om het risico van een elektrische schok te voorkomen als de kabel wordt losgetrokken. De elektrische installatie moet voorzien zijn van een differentiaalbeveiliging van 30 mA (cf § 3.4).
- Het niet naleven van deze aanbevelingen heeft het verlies van de garantie tot gevolg.

Instructies voor onderhoud

1 keer per jaar moeten er onderhoudswerken plaatsvinden om de levensduur en een goede werking van de warmtepomp te kunnen garanderen.

- Het onderhoud en de bediening dient uitgevoerd te worden volgens de in deze handleiding opgegeven aanbevolen tijden en frekwenties.
- Gebruik uitsluitend originele wisselstukken.
- Controleer de voedingskabel. Als de voedingskabel beschadigd is, moet deze worden vervangen door de fabrikant, zijn servicedienst of een bevoegd persoon.
- Controleer de aansluiting van het toestel op de aarde en de continuïteit ervan.
- Poets de verdampers met een zachte borstel, een luchtstraal of met water (**Opgelet, gebruik nooit een hogedrukreiniger**).
- Controleer of de condensaten goed afgevoerd worden.
- Controleer of de elektrische en hydraulische aansluitingen goed afsluiten.
- Controleer de hydraulische dichting van de condensor.
- De waterdichtheid van het koelcircuit **door een erkende professional** laten controleren met een lekdetector.



Voor ieder onderhoud moet de warmtepomp ontkoppeld worden van elke elektrische bron. Onderhoud mag enkel door een gekwalificeerde en bevoegde installateur gebeuren die gewend is met koelmiddelen om te gaan.

Instructies voor overwintering

- Zet de warmtepomp in Modus "OFF".
- Ontkoppel de voeding van de warmtepomp.
- Maak de condensor leeg met behulp van de aflaatopening om schade te vermijden. (belangrijk risico bij bevroering).
- Sluit de "by-pass"-klep af en schroef de aansluitingen op de in-/uitlaat los.
- Voer het resterende water in de condensor door middel van een luchtpistool af.
- Sluit de watertoevoer en -afvoer van de warmtepomp af om te vermijden dat vreemde voorwerpen binnendringen.

1. ALGEMENE INSTRUCTIES - VEILIGHEID (vervolg)

- Bedek de warmtepomp met de meegeleverde overwinteringshoes.



Eender welke schade veroorzaakt door een slechte overwintering, zorgt ervoor dat de garantie geannuleerd wordt.

Gebruiksvoorwaarden

Dit toestel kan worden gebruikt door kinderen vanaf 8 jaar oud en door personen met beperkte lichamelijke, zintuiglijke of geestelijke vermogens, of met gebrek aan ervaring of kennis, indien zij onder adequaat toezicht staan of indien zij instructies hebben gekregen over het veilige gebruik van het toestel en de daaraan verbonden risico's hebben begrepen. Laat kinderen niet met het toestel spelen. Reiniging en onderhoud door de gebruiker mogen niet worden uitgevoerd door kinderen zonder toezicht.

Dit product bevat R410A koelgas

Dit product bevat gefluoreerde broeikasgassen vastgelegd door het Kyotoprotocol. Laat deze gassen niet in de atmosfeer vrijkomen.

GWP-waarde⁽¹⁾: 2088, waarde gebaseerd op het 4e GIEC-rapport.

De hoeveelheid koudemiddel op basis van de F Gas 517/2014 regeling staat aangegeven op het typeplaatje van het apparaat.

Alle interventies op het koelcircuit moeten, zoals eerder vermeld, worden uitgevoerd door een erkend vakman.

Afhankelijk van de Europese of lokale wetgeving, moet regelmatig op koelmiddellekken gecontroleerd worden. Gelieve uw plaatselijke distributeur te contacteren voor meer informatie.

- Let op: koelmiddelen kunnen geurloos zijn.
- Doorboor of verhit de leidingen niet! Er bestaat risico op explosie en ernstige brandwonden.
- Gebruik alleen door de fabrikant aanbevolen middelen om het ontdooiingsproces of de reiniging te versnellen.
- Sla het toestel NIET op in een ruimte met continu werkende ontstekingsbronnen (zoals open vuur, gasapparaten of elektrische kachels).

(1) Aardopwarmingspotentieel

2. TECHNISCHE EIGENSCHAPPEN

2.1 Technische gegevens over de warmtepomp



Modell	ENERGYLINE PRO	ENP10TAS
Verwarmingcapaciteit *	kW	36,9
Energieverbruik *	kW	6,87
Elektriciteitsvermogen *	A	14,8
Voedingsspanning	V / Ph / Hz	400 V / 3N~ / 50Hz
Smeltzekering type aM	A	20
Stroomonderbreker met D-curve	A	20
Aantal compressoren	/	1
Compressortype	/	Scroll
Aantal ventilatoren	/	2
Ventilatorvermogen	W	50 - 225
Rotatiesnelheid van de ventilatoren	RPM	600 - 1050
Ventilatie	/	Horizontaal
Geluidsdruk niveau (op 10 meter afstand) LpA	dB(A)	41
Hydraulische aansluiting	mm	63
Nominaal waterverbruik*	m ³ /h	13
Waterdrukverlies (max)	kPa	13,8
Nettoafmetingen van de eenheid (L/B/H)	mm	1482 / 485 / 1480
Nettogewicht van de eenheid	kg	182

* Vermogen volgens de testnorm NF EN 14511, opgenomen in de verwijzing NF-414.
Droge lucht 15°C - Relatieve vochtigheid 71% - Ingangstemperatuur water 26°C.

2. TECHNISCHE EIGENSCHAPPEN (vervolg)

2.2 Werkgebied

Gebruik de warmtepomp in volgende temperatuur- en vochtigheidsbereiken om een correct en efficiënt te garanderen.

	Verwarmingsmodus 	Afkoelingsmodus 
Buitempreatuur	-12°C ~ +35°C	+7°C ~ +43°C
Watertemperatuur	+12°C ~ +40°C	+8°C ~ +40°C
Relatieve vochtigheid	< 80%	< 80%
Instelbereik van de gewenste waarde	+15°C ~ +32°C	+8°C ~ +32°C



Als de temperatuur of de vochtigheid niet aan deze voorwaarden voldoet, kunnen beveiligingen losraken en kan de warmtepomp niet meer werken.



De maximale verwarmingstemperatuur is 32°C om beschadiging van de liners te voorkomen. Hayward wijst alle aansprakelijkheid af in geval van gebruik boven 32°C.

2. TECHNISCHE EIGENSCHAPPEN (vervolg)

2.3 Afmetingen

Modell : ENP10TAS

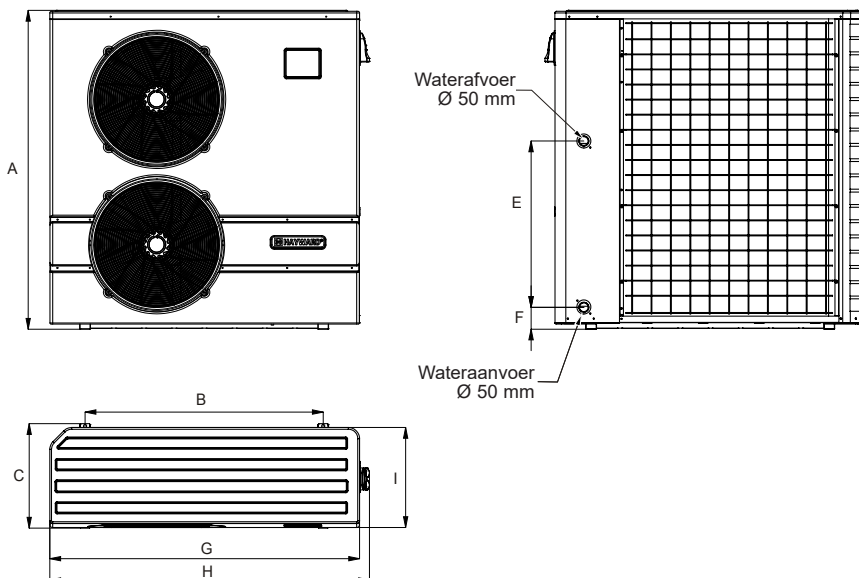

Eenheid : mm

Modell	ENP10TAS
Merkteken	
A	1480
B	1105
C	485
D	/
E	771,5
F	101,5
G	1437
H	1483
I	464

3. INSTALLATIE EN AANSLUITING

3.1 Basisschema

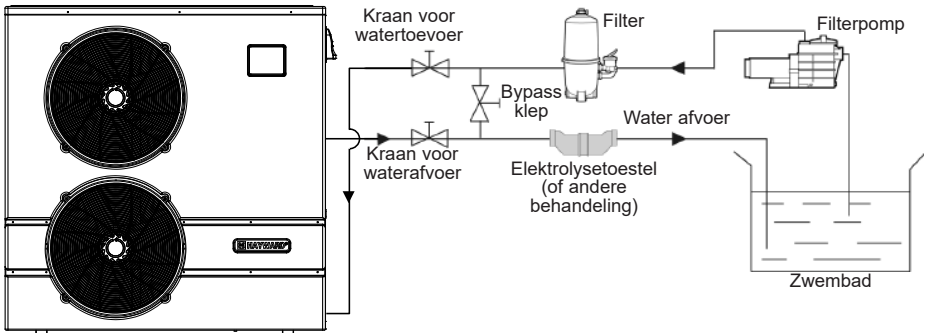

Noot : De warmtepomp wordt zonder enige behandelings- of filtereeruitrusting geleverd. De elementen die op de chart staan zijn onderdelen die de installateur moet leveren.

3.2 Warmtepomp



Plaats de warmtepomp buiten en niet in een afgesloten technische ruimte.

Kies een plaats die bij voorkeur zonnig is en beschut tegen harde wind. Het toestel moet gemakkelijk toegankelijk zijn voor latere installatie- en onderhoudswerkzaamheden.

Plaatsing onder een afdak waarbij de hieronder voorgeschreven minimumafstanden nageleefd moeten worden om elk gevaar op hercirculatie van lucht en verminderde algemene prestaties van de warmtepomp te vermijden.

Eenheid: mm

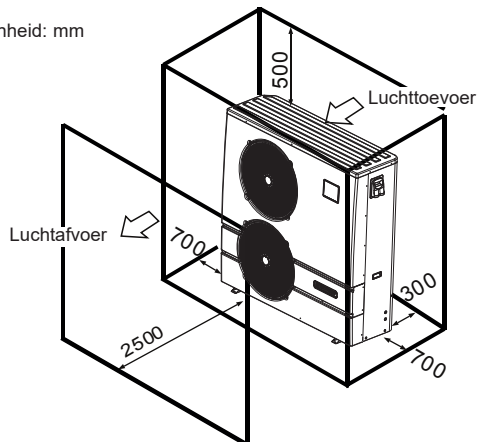

3. INSTALLATIE EN AANSLUITING (vervolg)



Plaats het toestel niet rechtstreeks op de vloer omdat dit storingen kan veroorzaken.

Plaats het toestel bij voorkeur op de vloer op anti-trillingsmatten.

Gebruik geen muurbevestiging in omstandigheden waarin trillingen kunnen worden doorgegeven.

Installeer de warmtepomp niet op een steun die de trillingen van het apparaat kan versterken.

Installeer de warmtepomp niet op een plaats waar het geluidsniveau kan worden versterkt of op een plaats waar het geluid van het apparaat de buurt kan verstoren.

Gebruik geen lijm: dit wordt niet beschouwd als een betrouwbaar bevestigingsmiddel.

Installeer de warmtepomp bij voorkeur op een vlakke, niet gekoppelde betonplaat (bijgeleverde schroeven en ringen).

Bevestig het toestel met het voorgeschreven aanhaalmoment om elk risico op ongevallen of schade aan apparatuur en personen te voorkomen.

Als alternatief kan de warmtepomp met behulp van geschikte moeren (niet meegeleverd) op rubberen vloersteunen worden geïnstalleerd.

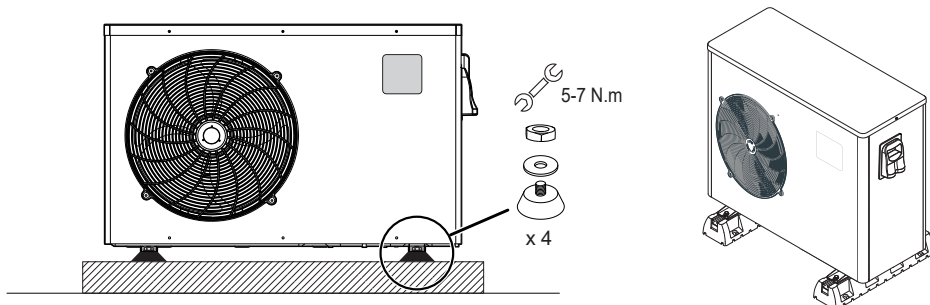

De maximumafstand tussen de warmtepomp en het zwembad is 15 meter.

De totale lengte van de hydraulische leidingen is 30 meter.

De bovengrondse en ondergrondse hydraulische kanalen isoleren.

De warmtepomp moet op een minimum afstand van het bassin worden geïnstalleerd conform de NF C 15-100 (dat wil zeggen op 3,5 m van het waterbassin voor Frankrijk) of conform de geldende installatienormen in andere landen.

Installeer de waterpomp niet in de buurt van een warmtebron.

In geval van installatie in regio's waar het geregeld sneeuwt, wordt aangeraden het apparaat overdekt te installeren om te voorkomen dat er zich sneeuw op de verdampers opstapelt.

3. INSTALLATIE EN AANSLUITING (vervolg)

3.3 Hydraulische aansluiting

De warmtepomp is voorzien van 2 aansluitingen met een diameter van 50 mm. Gebruik PVC-buizen voor de hydraulische leidingen Ø 50 mm. Sluit de watertoevoer van de warmtepomp op de leiding die van de filtergroep komt en sluit daarna de waterafvoer van de warmtepomp op de waterleiding die naar het zwembad loopt (cv tekening hieronder).

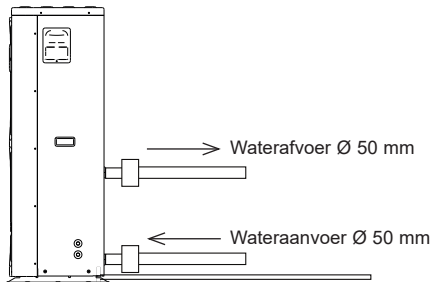

Installeer een bypassklep tussen de in- en uitgang van de warmtepomp.



Als u een automatische distributeur of een elektrolyseapparaat gebruikt, moet deze na de warmtepomp geïnstalleerd worden om de Titanium condensor tegen een te hoge concentratie aan chemische producten te beschermen.



Zorg ervoor dat de bypassklep en de aansluitingen op de aan- en afvoer van het water goed geïnstalleerd zijn om de drainage tijdens de winterperiode, de toegang en de demontage voor onderhoud te vergemakkelijken.

3. INSTALLATIE EN AANSLUITING (vervolg)

3.4 Elektrische aansluiting



De elektrische installatie en de bekabeling van deze uitrusting moeten conform zijn met de plaatselijk geldende normen.

F	NF C15-100	GB	BS7671:1992
D	DIN VDE 0100-702	EW	EVHS-HD 384-7-702
A	ÖVE 8001-4-702	H	MSZ 2364-702/1994/MSZ 10-553 1/1990
E	UNE 20460-7-702 1993, RECBT ITC-BT-31 2002	M	MSA HD 384-7-702.S2
IRL	Wiring Rules + IS HD 384-7-702	PL	PN-IEC 60364-7-702:1999
I	CEI 64-8/7	CZ	CSN 33 2000 7-702
LUX	384-7.702 S2	SK	STN 33 2000-7-702
NL	NEN 1010-7-702	SLO	SIST HD 384-7-702.S2
P	RSIUEE	TR	TS IEC 60364-7-702



Controleer of de elektrische voeding en de netwerkfrequentie overeenstemmen met de vereiste werkstroom, door rekening te houden met de specifieke plaatsing van het toestel en de noodzakelijke stroom om alle andere toestellen die op hetzelfde circuit aangesloten zijn, te voeden.



ENP10TAS 400 V \sim +/- 10 % 50 Hz 3 fasen

→ **Controleer of het fasenevenwicht niet meer dan 2% bedraagt**

Bestudeer het overeenkomstige bedradingsschema in bijlage.

De aansluitdoos bevindt zich aan de rechterkant van de eenheid. Drie connecties zijn voor de elektrische voeding en twee voor de besturing van de warmtepomp (Bediening).

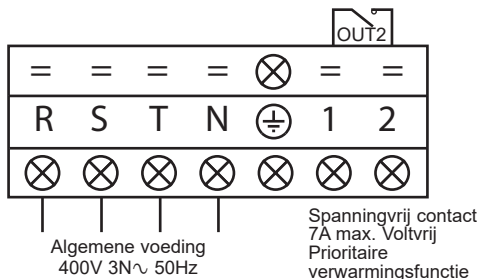

3. INSTALLATIE EN AANSLUITING (vervolg)



Gebruik nooit een stopcontact voor de stroomvoorziening. De stroomvoorziening moet naar behoren worden uitgerust met een omnipolaire beveiligingsinrichting van het D-curve type onderbreker en een 30mA differentieelschakelaar (zie tabel hieronder).

Modell		ENP10TAS
Elektrische voeding	V/Ph/Hz	400V 3N~ 50Hz
Smeltzekering type aM	A	20 aM
Stroomonderbreker met D-curve	A	20 D
Kabelsectie	mm ²	5G4 5 x 4



Gebruik een voedingskabel van het type RO2V/R2V of equivalent.



De kabelsecties worden gegeven voor een maximale lengte van 25 m. Deze moeten echter worden gecontroleerd en aangepast afhankelijk van de installatieomstandigheden.



Schakel altijd de hoofdschakelaar uit alvorens de elektriciteitsdoos te openen.

3.5 Eerste gebruik

Opstartprocedure - zodra de installatie beëindigd is, moet u de volgende stappen volgen en respecteren :

- 1) Draai de ventilatoren handmatig om te controleren of deze met de hand gedraaid kunnen worden en of het blad op de motorboom bevestigd is.
- 2) Controleer of de eenheid correct op de hoofdvoeding aangesloten is (zie bedradingschema in bijlage).
- 3) Activeer de filterpomp.
- 4) Controleer of alle waterkleppen openstaan en dat het water naar de eenheid loopt alvorens in verwarming of koeling opstart.
- 5) Controleer of de drainageleiding correct vastgemaakt is en niet verstopt is.
- 6) Schakel de elektrische voeding van de eenheid in en druk daarna op de Start/Stop-knop  op het controlepaneel.
- 7) Controleer of er geen enkele ALARM-code wordt weergegeven wanneer de eenheid op ON staat (zie gids voor probleemoplossing).

3. INSTALLATIE EN AANSLUITING (vervolg)

- 8) Leg het waterdebiet vast met behulp van de bypassklep (zie § 3.6 en 2.1), zoals respectievelijk vastgelegd is voor ieder model, zodat er een temperatuurverschil van 2°C is tussen het Binnenkomend en Uitgaand water.
- 9) Wanneer het toestel enkele minuten gedraaid heeft, controleer dan dat de lucht die eruit komt,afgekoeld is (tussen 5° en 10°).
- 10) Stop de filterpomp terwijl de eenheid blijft draaien. De eenheid moet automatisch stoppen en de foutcode E03 weergeven.
- 11) Laat de eenheid en de zwembadpomp 24u op 24u draaien todat de gewenste watertemperatuur bereikt is. Wanneer het binnenkomend water de gewenste temperatuur bereikt heeft, zal de eenheid stilvallen. Ze zal automatisch opstarten (als de zwembadpomp in werking is) als de temperatuur van het zwembad 0.5°C lager is dan de gewenste temperatuur.

Debietschakelaar - De eenheid is voorzien van een debietschakelaar die de warmtepomp inschakelt wanneer de filterpomp van het zwembad in werking is, en uitschakelt wanneer de de filterpomp stopt. Bij onvoldoende water zal de alarmcode E03 op de schakelaar getoond worden (Zie § 6.4).

Vertraging - De eenheid vertoont een vertraging van 3 minuten om de onderdelen van het besturingscircuit te beschermen en om onregelmatige opstart en storingen van de contactor te vermijden. Dankzij deze vertraging start de eenheid automatisch op ongeveer 3 minuten na een stroomonderbreking. Zelfs een korte stroomonderbreking zal de uitgestelde start activeren.

Faseregelaar - De driefasenunits zijn voorzien van een faseregelaar om de correcte draairichting van de compressor te garanderen.

Controleer, als de unit niet opstart, de staat van de faseregelaar in het elektrische kastje.

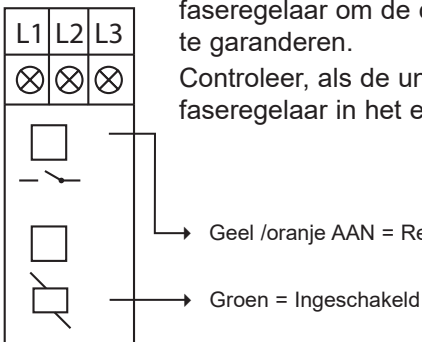

3. INSTALLATIE EN AANSLUITING (vervolg)

3.6 Instelling van het waterdebiet

Terwijl de kleppen voor binnenkomend en uitgaand water openstaan, moet u de bypassklep afstellen om een temperatuurverschil van 2°C tussen het binnenkomend en uitgaand water te bekomen (zie basisschema §3.1). U kan de instelling controleren voor de temperaturen van het binnenkomend en uitgaand water te visualiseren op het controlepaneel.

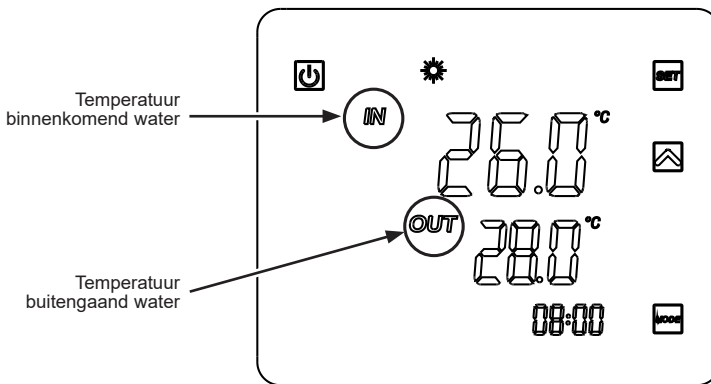

Opmerking : De opening van de bypassklep zorgt voor een lager waterdebiet.
De sluiting van de bypassklep zorgt voor een hoger waterdebiet.

4. GEBRUIKERSINTERFACE

4.1 Algemene voorstelling

De warmtepomp is uitgerust met een digitaal besturingspaneel met touchscreen, elektrisch aangesloten en voorgeïnstalleerd in verwarmingsmodus.

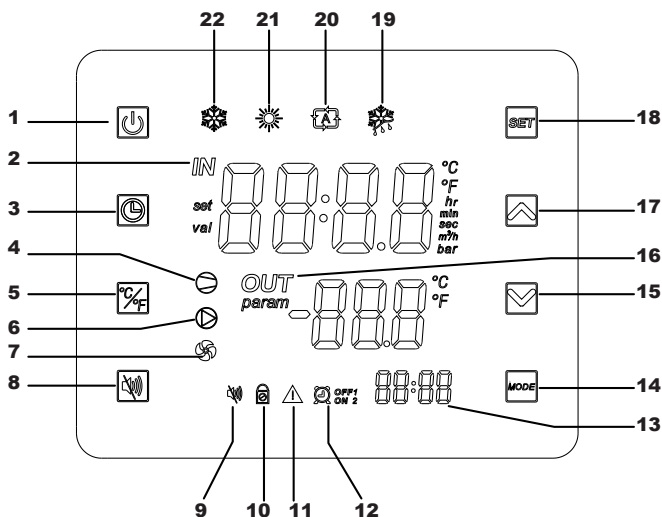

Legende

1		Start/Stop
2	IN	Binnenkomend water
3		Instelling uur en Timer
4		Compressor ON
5		Conversie °C/°F
6		Droog contact OUT2
7		Fan ON
8		Stille modus
9		Verklikkerlampje stille modus
10		Scherm vergrendeld
11		Alarm

12		Timers 1 en 2
13		Tijd van de timers
14	MODE	Kiezen van de modus
15		Schuifbalk onderaan / Verlagen
16	OUT	Buitengaand water
17		Schuifbalk bovenaan / Verhogen
18	SET	Opslaan/Instellingen
19		Modus de-icing
20		Automatische modus
21		Verwarmingsmodus
22		Afkoelingsmodus

4. GEBRUIKERSINTERFACE (vervolg)

Modus OFF

Wanneer de warmtepomp in slaapstand staat (Modus OFF), kan u "OFF" op het scherm van de schakelaar aflezen.

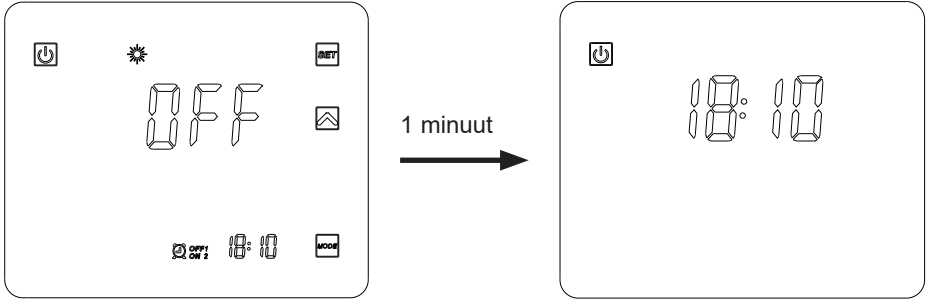

Modus ON

Wanneer de warmtepomp in werking of in gebruik is (Modus ON), zijn de inkomende en uitgaande watertemperaturen op het scherm van de schakelaar af te lezen.

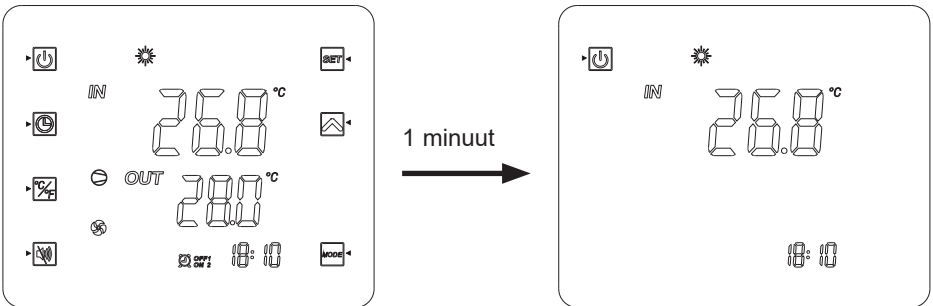









4. GEBRUIKERSINTERFACE (vervolg)

Aan het einde van de instellingen op  te bevestigen.
Instellingen de opname automatisch na '20 zonder actie.

4.2 De klok instellen

Als de weergave in de slaapmodus staat, drukt u kort op knop .



- 1) Druk op  voor weergave van het symbool .
- 2) Druk op , de tijdweergave knippert. Stel de uren in met behulp van de knoppen  .
- 3) Druk op  en stel de minuten in met behulp van de knoppen  .
- 4) Valideer door te drukken op .

4.3 De Timer instellen











De instellingen van deze functie zijn noodzakelijk zodra u uw warmtepomp binnen een kortere termijn dan vastgelegd door de filterklok wilt gebruiken. Op die manier kunt u een uitgestelde start en een vroegtijdige uitschakeling programmeren of eenvoudigweg een periode waarin de pomp niet gebruikt mag worden.

U kunt 2 Timers Start (ON1 en ON2) en 2 Timers Stop (OFF1 en OFF2) programmeren.

Programmeren Timer 1 – Starttijd

- 1) Druk 2 s op , de Timer ON1  knippert (*).
- 2) Druk op  om de uren in te stellen met behulp van de knoppen  .
- 3) Druk op  om de minuten in te stellen met behulp van de knoppen  .
- 4) Valideer door te drukken op .

Programmeren Timer 1 – Stoptijd

- 1) Druk 2 s op , de Timer ON1  knippert (*).
Druk 1 keer op , de Timer OFF1  knippert.
- 2) Druk op  om de uren in te stellen met behulp van de knoppen  .
- 3) Druk op  om de minuten in te stellen met behulp van de knoppen  .
- 4) Valideer door te drukken op .

(*) Om direct naar Timer ON2 , drukt u 2 s op  en vervolgens 2 keer op .

4. GEBRUIKERSINTERFACE (vervolg)

Programmeren Timer 2

Na het instellen van Timer 1, gaat u direct naar de instellingen van Timer 2:



Volg de dezelfde stappen als voor instelling van Timer 1.

Nota: Om direct naar Timer ON2 , drukt u 2 s op  en vervolgens 2 keer op .

Verwijderen van de Timers (Start en Stop)

- 1) Druk 2 s op , de Timer ON1  knippert. (*)
- 2) Druk op , de weergave van de uren knippert.
- 3) Druk op  om de Timer  te verwijderen.
- 4) Valideer door te drukken op .
- 5) Druk 2 s op , de Timer ON1  knippert.
Druk 1 keer op , de Timer  knippert. (*)
- 6) Druk op , de weergave van de uren knippert.
- 7) Druk op  om de Timer  te verwijderen.

(*) Om naar de Timers 2 of  en , volgt u de stappen 1) of 4) en druk vervolgens 2 keer op . Volg de stappen hieronder.

4.4 Gebruiksmodus

In Modus "OFF" of "ON"

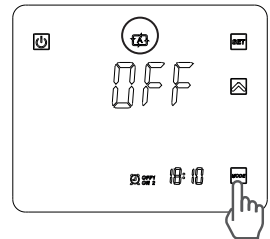
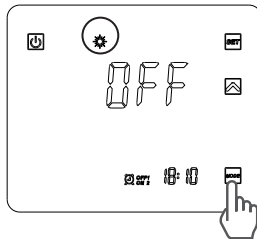
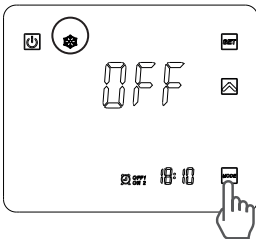

Druk op de toets  om te schakelen tussen: koelen, verwarmen of auto.



Als de warmtepomp wordt enkel in de te verwarmen of alleen koelen modus, de modus wijzigen is niet mogelijk.

4. GEBRUIKERSINTERFACE (vervolg)



4.5 Instelbereik en visualisatie van de gewenste waarde (Gewenste watertemperatuur)

Als de knop  niet zichtbaar is op het scherm, drukt u kort op .

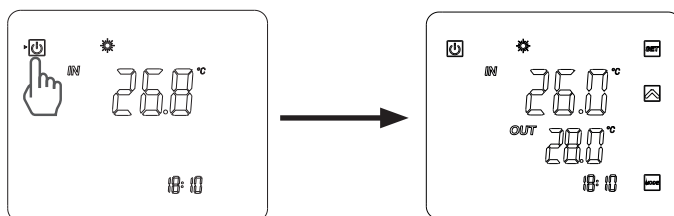
(Zowel in werking als in stilstand drukt u op de knop  om de instructies weer te geven.)



In Modus "OFF" en "ON"

Druk op de knop  om de instructies weer te geven, en druk vervolgens op  of  om de gewenste instructie te kiezen.

De waarde kan tot op 0.5°C nauwkeurig ingesteld worden.



Het is aangewezen nooit de 30°C te overschrijden om te vermijden dat de liners verkleuren.

4.6 Het touchscreen vergrendelen en ontgrendelen

Druk 5 sec op de Start/Stop-knop  totdat u een biep hoort en het symbool  ziet verschijnen.

Druk 5 sec op de Start/Stop-knop  totdat u een biep hoort en het symbool  ziet verdwijnen .

4. GEBRUIKERSINTERFACE (vervolg)

4.7 Instelling van de silence modus

Met deze functie kunt u de warmtepomp gebruiken met een verminderde rotatiesnelheid van de ventilatoren van 600Tr/min gedurende maximaal 8 uur, om geluidsoverlast 's nachts en/of overdag te beperken afhankelijk van de plaats van de pomp ten opzichte van de burens of het bassin.



Deze functie kan zowel handmatig als met behulp van een timer geactiveerd/gedeactiveerd worden.

Handmatige activering

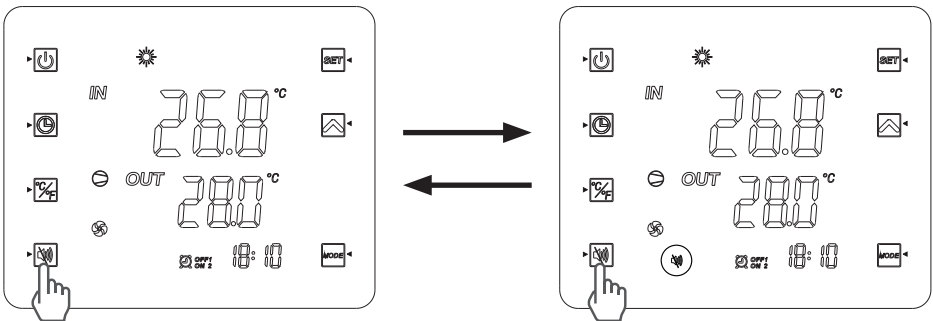
- 1) Druk op de knoppen .
- 2) De weergave hieronder verschijnt op het scherm, de stille modus is geactiveerd voor de komende 8 uur
- 3) De ventilatoren verminderen geleidelijk hun rotatiesnelheid gedurende maximaal 8 uur.
- 4) Na 8 uur wordt de functie automatisch gedeactiveerd en gaan de ventilatoren weer over op een rotatiesnelheid die afhankelijk is van de temperatuur van de buitenlucht.



Handmatige deactivering

- 1) Druk op de knoppen .
- 2) Het verklikkerlampje  verdwijnt van het scherm: de stille modus is gedeactiveerd.
- 3) De ventilatoren passen hun rotatiesnelheid aan op basis van de buitentemperatuur.

4. GEBRUIKERSINTERFACE (vervolg)



Programmering van de STILTE modus

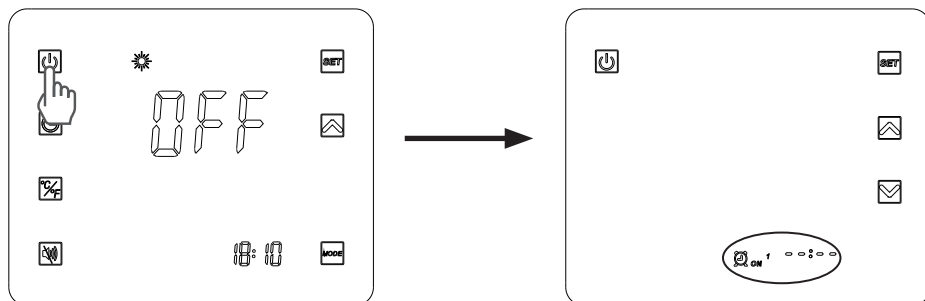

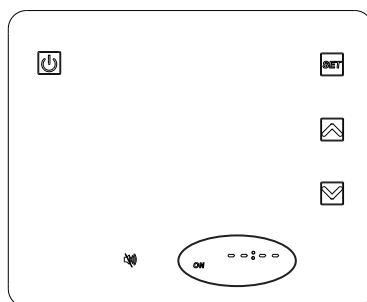

1) Druk 2 s op , de Timer ON1  ON 1 knippert.



2) Druk 4 keer op  tot het onderstaande scherm verschijnt.









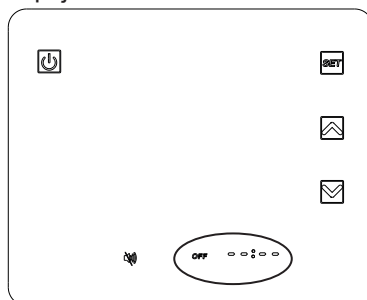

3) Druk op , de urenweergave knippert. Gebruik de pijltjes   om de uren van de starttijd in te stellen.

4) Druk op , de minutenweergave knippert. Gebruik de pijltjes   om de minuten van de starttijd in te stellen. Valideer door te drukken op .

5) Druk op  om de stoptijd in te stellen: de indicatie **OFF** knippert.



4. GEBRUIKERSINTERFACE (vervolg)

- 6) Druk op , de urenweergave knippert. Gebruik de pijltjes   om de uren van de stoptijd in te stellen.
- 7) Druk op , de minutenweergave knippert. Gebruik de pijltjes   om de minuten van de stoptijd in te stellen. Valideer door te drukken op .
- 8) Druk op  om terug te gaan naar het vorige scherm.
De indicaties ON-OFF worden zoals hieronder weergegeven.

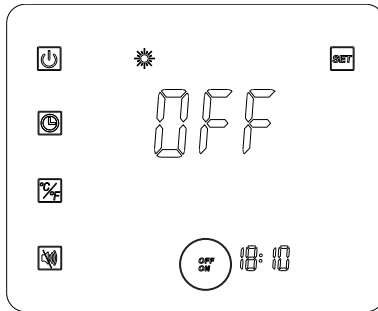

Nota : De minuten worden per 10 ingesteld.

Als de instelling van de SILENCE modus klaar is, wordt deze standaard 7 dagen per week geactiveerd.

5. ONDERHOUD EN OVERWINTERING

5.1 Onderhoud

1 keer per jaar moeten er onderhoudswerken plaatsvinden om de levensduur en een goede werking van de warmtepomp te kunnen garanderen.

- Het onderhoud en de reparaties van het toestel moeten worden uitgevoerd door een erkend vakman overeenkomstig de voorschriften en beste praktijken die gelden in het land waar het toestel wordt geïnstalleerd (zie § 3.4). Voor elke interventie op het koelcircuit moet de installateur beschikken over een certificaat van bekwaamheid om met koelmiddelen om te gaan.
- Controleer de voedingskabel. Als de voedingskabel beschadigd is, moet deze worden vervangen door de fabrikant, zijn servicedienst of een bevoegd persoon.
- Controleer de aansluiting van het toestel op de aarde en de continuïteit ervan.
- Poets de verdampers met een zachte borstel, een luchtstraal of met water **Opgelet, gebruik nooit een hogedrukreiniger**.
- Controleer of de condensaten goed afgevoerd worden.
- Controleer of de elektrische en hydraulische aansluitingen goed afsluiten.
- Controleer de hydraulische dichting van de condensor.
- De waterdichtheid van het koelcircuit **door een erkende professional** laten controleren met een lekdetector.



Voor ieder onderhoud moet de warmtepomp ontkoppeld worden van elke elektrische bron. Onderhoud mag enkel door een gekwalificeerde en bevoegde installateur gebeuren die gewend is met koelmiddelen om te gaan.

5.2 Overwintering

- Zet de warmtepomp in Modus "OFF".
- Ontkoppel de voeding van de warmtepomp.
- Maak de condensor leeg met behulp van de aflatopening om schade te vermijden. (belangrijk risico bij bevroering).
- Sluit de "by-pass"-klep af en schroef de aansluitingen op de in-/uitlaat los.
- Voer het resterende water in de condensor door middel van een luchtpistool af.
- Sluit de watertoevoer en -afvoer van de warmtepomp af om te vermijden dat vreemde voorwerpen binnendringen.
- Bedek de warmtepomp met de meegeleverde overwinteringshoes.



Eender welke schade veroorzaakt door een slechte overwintering, zorgt ervoor dat de garantie geannuleerd wordt.

6. BIJLAGEN

6.1 Elektrische schema

ENP10TAS

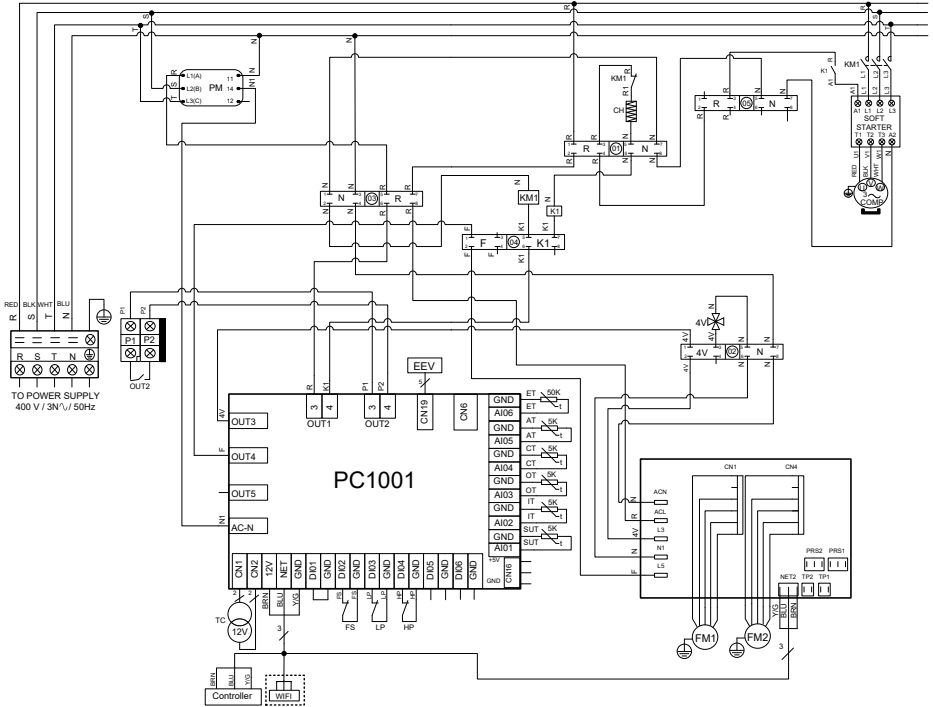

OPMERKINGEN :

- AT : LUCHTTEMPERATUURSENSOR
- COMP : COMPRESSOR
- CT : CONDENSATIETEMPERATUUR SENSOR
- EEV : ELEKTRONISCHE DRUKREGELAAR
- FM1-2 : VENTILATORMOTOR
- FS : WATERDETECTOR
- HP : HOGEDRUKSCHAKELAAR
- IT : TEMPERATUURSENSOR VOOR BINNENKOMEND WATER
- LP : LAGEDRUKSCHAKELAAR

- OT : TEMPERATUURSENSOR VOOR BUITENGAAND WATER
- SUT : AANZUIGTEMPERATUURSENSOR
- TC : TRANSFORMATOR 230V~ / 12V~
- 4V : 4-WEGSKRAAN
- KM1 : VERMogensSCHAKELAAR COMPRESSOR
- PM : FASEREGELAAR
- CH1 : CARTERWEERSTAND
- ET : TEMPERATUURSENSOR OPSTUWING WATER
- OUT2 : VOLT VRIJ CONTACT MAX 7 A
- [] : OPTIONEEL

6. BIJLAGEN (vervolg)

6.2 Aansluitingen prioriteit verwarming driefasenpomp

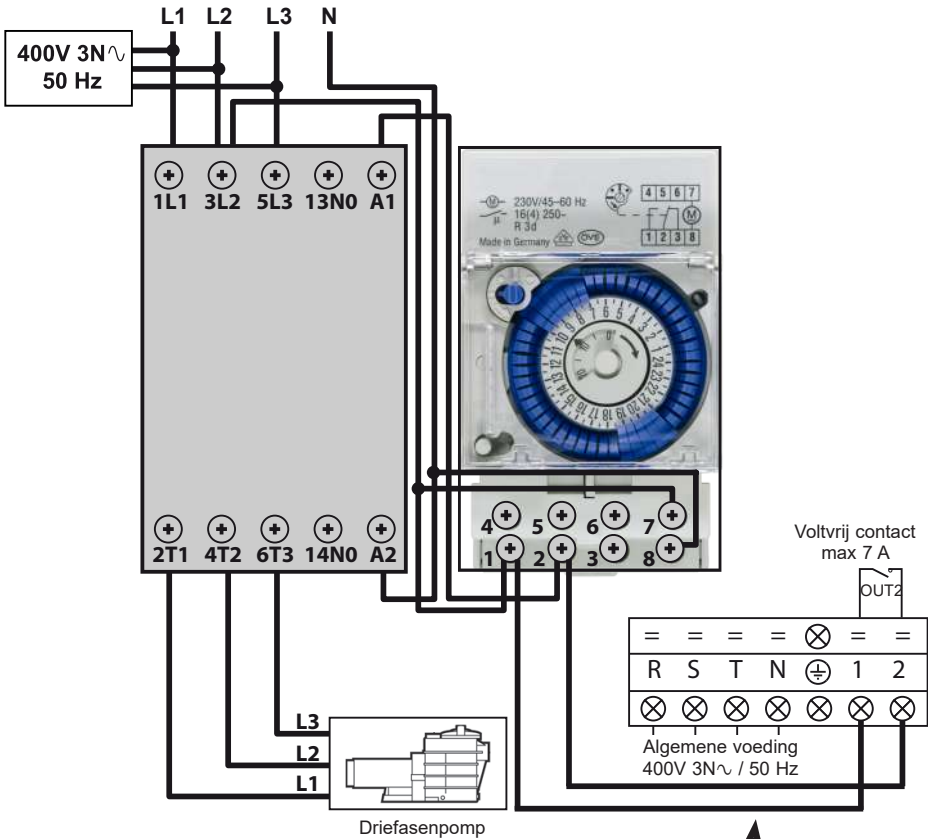

De zuilen 1-2 leveren een spanningvrij contact, zonder polariteit 230 V~ / 50 Hz.

Sluit de zuilen 1 en 2 met kabels aan zoals op het schema hierboven is aangegeven zodat de werking van de filterpomp wordt ingesteld op een cyclus van 2 minuten per uur als de temperatuur van het bassin lager is dan aanbevolen.

 De voeding van de filterpomp nooit direct aansluiten op de zuilen 1 en 2.



Opzettelijk leeg gelaten pagina

6. BIJLAGEN (vervolg)

6.3 Opengewerkte tekeningen en onderdelen

ENP10TAS

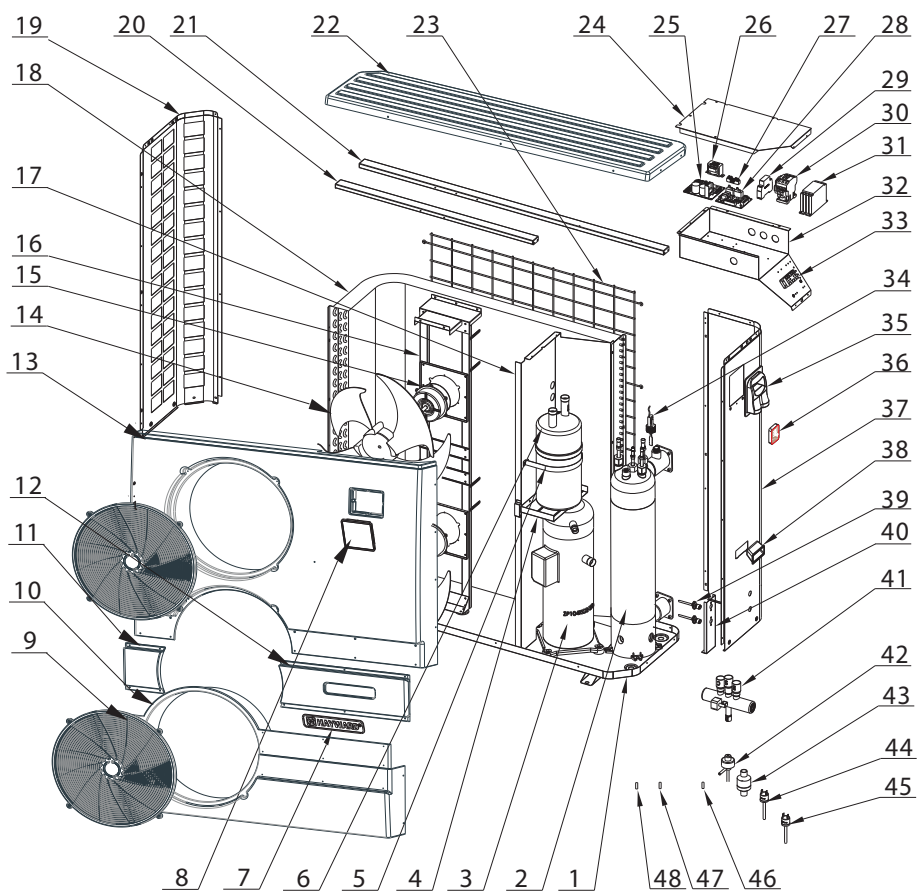

6. BIJLAGEN (vervolg)

ENP10TAS

Nr.	Ref.	Omschrijving	Nr.	Ref.	Omschrijving
1	HWX32005210049	Bodem	27	HWX20003909	Aansluitblok 2 aansluitingen
2	HWX32005120009	Titaancondensator/pvc	28	HWX950531014516	Elektronische kaart
3	HWX20000110153	Compressor	29	HWX200036023	Fase controller
4	HWX32027210011	Steun waterreservoir	30	HWX20000360209	Relais compressor drie Fase
5	HWX32027210013	Sluitketting	31	HWX20000360092	Elektronische starter TRI
6	HWX35141402	Vloeistofreservoir	32	HWX32005210054	Elektriciteitskast
7	HWX20000230596	Logo Hayward	33	HWX20000390180	Aansluitblok 5 aansluitingen Tri
8	HWX95005010018	LED regulator	34	HWX200036005	Detector waterdebiet
9	HWX32020220001	Beschermingsrooster ventilator	35	HWX32009220032	Elektrische toegangsopening
10	HWX32005220002	Paneel voorkant onder	36	HWX95005010014	WiFi-module
11	HWX32005220005	Decoratief paneel links	37	HWX32005210060	Rechterpaneel
12	HWX32005220004	Decoratief paneel rechts	38	HWX32008220037	Greep
13	HWX32005220001	Paneel voorkant boven	39	HWX20000140353	Drukaftakking HD&LD
14	HWX20000270025	Ventilatorblad	40	HWX32019210038	Steunplaat stekkers HS/LS
15	HWX20000330361	Motor DC	41	HWX20011488	4-wegskraan
16	HWX32005210058	Motorsteun	42	HWX20000140338	Elektronisch reduceerventiel
17	HWX32005210065	Afscheidingspaneel	43	HWX20041455	Filter
18	HWX32005120008	Verdamper	44	HWX20003603	Drukregelaar lage druk
19	HWX32005210051	Linkerpaneel	45	HWX20013605	Drukregelaar hoge druk
20	HWX32005220055	Korte draadspanner	46/47	HWX20003242	Temperatuursonde evaporator/lucht/water
21	HWX32005210056	Lange draadspanner	48	HWX20003223	Compressorsonde 50 kΩ
22	HWX32005220003	Paneel bovenaan	*49*	HWX20000240208	Winterhoes
23	HWX32005210063	Bescherming verdamper	*50*	HWX200026009	O-ring ID 48-Ep 5 mm
24	HWX32005210053	Elektrisch beschermpaneel	*51*	HWX200026061	O-ring ID 43-Ep 3,4 mm
25	HWX950531024107	Module DC Inverter	*52*	HWX20003214	Cartenweerstand
26	HWX200037003	Transformator 230V~ - 12V~	*53*	HWX20002625	Silent bloc

NB: de punten *XX* zijn niet vermeld op overeenkomstige explosietekening

6. BIJLAGEN (vervolg)



6.4 Gids voor het probleemoplossing

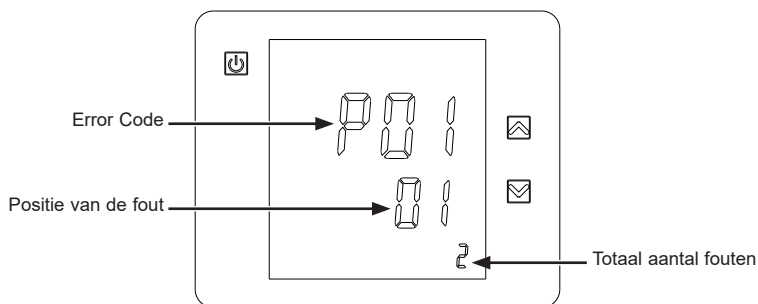

Sommige handelingen mogen enkel door een bevoegd techniker uitgevoerd worden.

In geval van een defect, worden de volgende indicaties op het scherm weergegeven:



In geval van meerdere fouten, drukt u op  of  om de foutcodes te bekijken. Zie het onderstaande overzicht.

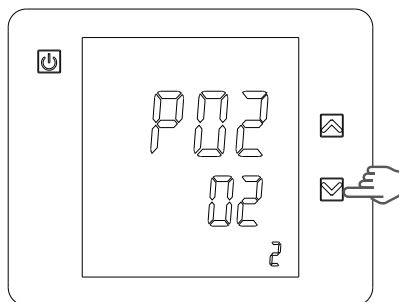

6. BIJLAGEN (vervolg)

Probleem	Foutcodes	Omschrijving	Oplossing
Inlaat watertemperatuur sensor fout	P01	De sensor is open of in kortsluiting	Controleer of vervang de sensor
Uitlaat watertemperatuur sensor fout	P02	De sensor is open of in kortsluiting	Controleer of vervang de sensor
Ontdooisensor fout	P05	De sensor is open of in kortsluiting	Controleer of vervang de sensor
Omgevingstemperatuursensor fout	P04	De sensor is open of in kortsluiting	Controleer of vervang de sensor
Defect aspiratiesonde compressor	P07	De sensor is open of in kortsluiting	Controleer of vervang de sensor
Temperatuurverschil tussen waterinvoer en -uitlaat is groot	E06	Volume van waterdebiet is onvoldoende, waterdrukverschil is te zwak/te hoog	Controleer het waterdebiet, of de verstopping in het systeem.
Antivriesbescherming Koude Modus	E07	Hoeveelheid uitgaand water is te zwak.	Controleer het waterdebiet of de sensor voor uitgaand water.
Antivriesbescherming van niveau 1	E19	Omgevingstemperatuur of temperatuur van het inkomend water is te laag.	
Antivriesbescherming van niveau 2	E29	Omgevingstemperatuur of temperatuur van het inkomend water is nog lager.	
Overdrukbescherming	E01	De druk van het koelcircuit is te hoog, of het waterdebiet is te zwak, of de verdamper is verstopt, of het luchtdebiet is te zwak.	Controleer de hogedrukregelaar en de druk van het koelcircuit Controleer het water- of luchtdebiet. Controleer of de debietschakelaar goed werkt. Controleer of de kranen voor binnenkomend en uitgaand water openstaan. Controleer de bypass instelling.
Onderdrukbescherming	E02	Druk van het koelcircuit is te zwak, of het luchtdebiet is te zwak, of de verdamper is verstopt.	Controleer de lagedrukregelaar en de druk van het koelcircuit om na te gaan of er een lek is. Poets de buitenkant van de verdamper. Controleer de rotatiesnelheid van de ventilator. Controleer de vrije luchtcirculatie door de verdamper.
Debietmeter fout	E03	Waterdebiet is onvoldoende of de meter is in kortsluiting of defect.	Controleer het waterdebiet, de filterpomp en de debietmeter om na te gaan of er eventuele storingen zijn.
Communicatieprobleem	E08	Probleem met de LED-controller of het PCB-connectie.	Controleer de verbinding van de kabels NET en NET1.
De compressor start niet	E08	Ontbrekende fase of onjuiste fasevolgorde	controleer de aanwezigheid van de 3 fasen wijzig de fasevolgorde op het elektrische aansluitblok van de warmtepomp

6. BIJLAGEN (vervolg)

6.5 Garantie

GARANTIEVOORWAARDEN

Alle HAYWARD-producten vallen onder garantie in geval van fabrieks- of materiaalfouten gedurende twee jaar vanaf de aankoopdatum. Elke garantieaanvraag moet samen met een aankoopbewijs met datum ingediend worden. Wij dringen er dus op aan dat u uw factuur bewaart.

De HAYWARD-garantie is beperkt tot reparatie of vervanging, bepaald door HAYWARD, van de defecte toestellen zolang ze op een normale wijze en volgens de voorschriften die in de handleiding vermeld, gebruikt zijn, het apparaat niet aangepast is en enkel gebruikt is in met HAYWARD componenten en onderdelen. Schade veroorzaakt door vrieskou en chemische agensen vallen niet onder garantie. Alle andere kosten (transport, werkuren...) worden niet door de garantie gedekt.

HAYWARD kan niet verantwoordelijk gesteld worden voor eender welke directe of indirecte schade veroorzaakt tijdens de installatie, aansluiting of onjuist gebruik van een product.

Om een garantie aan te vragen en herstel of vervanging van een product te eisen, moet u zich tot uw verdeler wenden. Wij zullen geen enkele retour naar de fabriek aanvaarden zonder een vooraf bekomen schriftelijke goedkeuring.

Slijtage valt niet onder garantie.

6.6 Einde levensduur van het toestel



Het symbool van de doorgekruiste vuilnisbak voor de verwerking en nuttige toepassing van elektrisch en elektronisch afval betekent dat de producten niet bij het huisvuil, het grofvuil of op een stortplaats mogen worden gedeponeerd.

 Aan het einde van zijn levensduur moet het toestel apart worden ingezameld voor recycling of hergebruik. In de Europese Unie en Noorwegen bestaat een specifiek inzamelingsstelsel voor dit soort producten.

Neem contact op met uw installateur of plaatselijke vertegenwoordiger om de inzameling, ontmanteling en recycling van dit toestel te regelen.

Het hergebruik van koelmiddel, olie en andere onderdelen moet worden uitgevoerd door een gekwalificeerde vakman in overeenstemming met de lokale en nationale wetgeving.

Als het product batterijen bevat die met dit symbool zijn gemarkeerd, betekent dit dat de batterijen schadelijke of verontreinigende stoffen kunnen bevatten. Geef de batterijen in dat geval af bij een inzamelpunt voor gebruikte batterijen.

ENERGYLINE PRO

UNITÀ DI RISCALDAMENTO A POMPA DI CALORE PER PISCINE



ENP10TAS

Manuale d'Uso e di Installazione

INDICE

1. ISTRUZIONI GENERALI - SICUREZZA	1
2. SPECIFICHE TECNICHE	4
2.1 Prestazioni	4
2.2 Soglie di funzionamento	5
2.3 Dimensioni	6
3. INSTALLAZIONE E COLLEGAMENTO	7
3.1 Schema di principio	7
3.2 Pompa di calore	7
3.3 Collegamento idraulico	9
3.4 Collegamento Elettrico	10
3.5 Primo avviamento	11
3.6 Regolazione della portata d'acqua	13
4. INTERFACCIA UTENTE	14
4.1 Presentazione generale	14
4.2 Configurazione dell'orologio	16
4.3 Configurazione della funzione timer	16
4.4 Selezione della modalità operativa	17
4.5 Configurazione e visualizzazione set point	18
4.6 Blocco e sblocco del touch screen	18
4.7 Regolazione modalità silenzio	19
5. MANUTENZIONE E SVERNAMENTO	22
5.1 Manutenzione	22
5.2 Svernamento	22
6. APPENDICI	23
6.1 Schemi Elettrici	23
6.2 Collegamenti priorità riscaldamento pompa trifase	24
6.3 Esplosa e parti di ricambio	26
6.4 Guida alla Risoluzione dei Problemi	28
6.5 Garanzia	30
6.6 Fine vita dell'apparecchio	30

Leggere attentamente e riporre in luogo facilmente accessibile per la consultazione.

La presente documentazione deve essere consegnata al proprietario della piscina, il quale dovrà conservarla in un luogo sicuro.

1. ISTRUZIONI GENERALI - SICUREZZA

Grazie per aver acquistato un'unità di riscaldamento a pompa di calore per piscine Hayward. Questo prodotto è stato progettato secondo le più rigorose norme di fabbricazione per rispondere ai livelli di qualità richiesti. Questo manuale contiene tutte le informazioni necessarie per l'installazione, la ricerca guasti e la manutenzione ordinaria del prodotto. Leggere attentamente il manuale prima di aprire l'unità o eseguire degli interventi di manutenzione sul prodotto. Il fabbricante del prodotto declina ogni responsabilità per lesioni a persone e danni al prodotto riconducibili a errori di installazione, di ricerca guasti oppure a manutenzione inadeguata. È imperativo attenersi sempre alle istruzioni riportate nel presente manuale.

Al termine della lettura, conservare il manuale per future consultazioni.

Personale abilitato

- L'installazione, i collegamenti elettrici, la manutenzione e le riparazioni dell'apparecchio devono essere effettuati da un professionista autorizzato conformemente allo stato dell'arte e ai testi regolamentari vigenti nel paese in cui l'apparecchio è installato (v. § 3.4). In caso di intervento sul circuito frigorifero, il professionista deve essere in possesso di un'attestazione di capacità alla manipolazione di fluidi frigoriferi.

Per la Francia:

- Impianto elettrico in bassa tensione in base alla norma NF-C 15-100.
- Legislazione sulla manipolazione dei fluidi frigoriferi: decreto 2007/737 e relative ordinanze applicative.

Condizioni di installazione

- Non cercare di installare da soli l'apparecchio.
- Questo prodotto è stato esclusivamente progettato per un utilizzo domestico e un'installazione esterna. L'aria che fuoriesce dal prodotto deve poter scorrere liberamente e non deve essere utilizzata per altri fini, come il riscaldamento o il raffreddamento di locali o edifici.
- Questa pompa di calore riscalda l'acqua della piscina e mantiene una temperatura costante, non utilizzarla per altri scopi.
- Verificare il cavo dell'alimentazione. Se il cavo dell'alimentazione risulta danneggiato, questo dovrà essere sostituito dal fabbricante, da un addetto dell'assistenza post-vendita del produttore o da una persona qualificata e abilitata.

1. ISTRUZIONI GENERALI - SICUREZZA (seguito)

- Il collegamento dell'apparecchio alla terra e la sua continuità sono obbligatori. Il filo di terra deve essere più lungo degli altri fili onde evitare rischi di scosse elettriche in caso di strappamento del cavo. L'impianto elettrico deve obbligatoriamente essere provvisto di una protezione differenziale da 30 mA (cf § 3.4).
- Il mancato rispetto delle presenti indicazioni annulla la garanzia.

Istruzioni per la manutenzione

Per garantire la longevità e il corretto funzionamento dell'Unità di Riscaldamento a Pompa di Calore per Piscine, le presenti operazioni di manutenzione devono essere effettuate 1 volta all'anno.

- Le operazioni di manutenzione devono essere eseguite rispettando la frequenza e le modalità indicate nel presente manuale.
- Utilizzare esclusivamente parti di ricambio originali.
- Controllare il cavo di alimentazione. Se il cavo di alimentazione è danneggiato, deve essere sostituito dal produttore, dal suo servizio post-vendita o da una persona qualificata e abilitata.
- Verificare il collegamento dell'apparecchio alla terra e la sua continuità.
- Pulire l'evaporatore con una spazzola morbida, un getto di aria compressa o con acqua (**Attenzione: non utilizzare in nessun caso idropulitrici**).
- Controllare che lo scarico della condensa avvenga correttamente.
- Controllare che i collegamenti idraulici e quelli elettrici siano serrati correttamente.
- Controllare la tenuta idraulica del condensatore.
- Far controllare la tenuta del circuito frigorifero al rilevatore di perdite da un **professionista autorizzato**.



Prima di eseguire qualsiasi operazione di manutenzione, assicurarsi che l'unità sia scollegata da ogni fonte di corrente elettrica. Le operazioni di manutenzione devono essere effettuate esclusivamente da personale qualificato e abilitato alla manipolazione di fluidi frigorigeni.

Istruzioni per lo svernamento

- Mettere l'unità in Modalità "OFF".
- Interrompere l'alimentazione dell'unità.
- Svuotare il condensatore tramite l'apposito scolo per evitare eventuali rischi di degrado. (elevato rischio di congelamento).
- Chiudere la valvola by-pass e svitare i raccordi di unione ingresso/uscita.
- Eliminare dal condensatore l'acqua stagnante residua servendosi di una pistola ad aria compressa.

1. ISTRUZIONI GENERALI - SICUREZZA (seguito)

- Ostruire l'ingresso e l'uscita dell'acqua dell'unità, al fine di evitare l'eventuale intrusione di corpi estranei.
- Coprire l'unità con l'apposito telo per l'inverno.



Eventuali danni causati da uno svernamento improprio invalideranno la garanzia.

Condizioni di utilizzo

Questo apparecchio può essere utilizzato da bambini che abbiano almeno 8 anni e da persone con capacità fisiche, sensoriali o mentali ridotte, o anche prive di esperienza o conoscenza, fermo restando che siano correttamente sorvegliate, siano state loro fornite istruzioni per un utilizzo dell'apparecchio in totale sicurezza e i rischi potenziali siano stati compresi.

I bambini non devono giocare con l'apparecchio.

La pulizia e la manutenzione da parte dell'utente non devono essere effettuate da bambini senza sorveglianza.

Questo prodotto contiene gas refrigerante R410A

Questo prodotto contiene gas fluorurati ad effetto serra disciplinati dal Protocollo di Kyoto. Non sprigionare questo gas nell'atmosfera.

Valore GWP⁽¹⁾: 2088, Valore basato sul 4° rapporto dell' GIEC.

La quantità di refrigerante basata sulla regolamentazione n. 517/ 2014 (F-Gas) è indicata sulla piastrina segnaletica dell'apparecchiatura.

Eventuali interventi sul circuito frigorifero devono essere effettuati da professionisti autorizzati come indicato sopra.

A seconda della legislazione europea o locale in vigore, è possibile che venga richiesto di effettuare ispezioni periodiche volte ad accertare eventuali perdite di refrigerante. Per maggiori informazioni, contattare il proprio rivenditore.

- Attenzione: i fluidi frigoriferi possono essere inodori.
- Non forare né riscaldare la tubazione: rischio di esplosione e ustioni gravi.
- Non utilizzare mezzi di accelerazione del processo di sbrinamento o pulizia diversi da quelli raccomandati dal fabbricante.
- L'apparecchio deve essere stoccato in un locale che non contenga sorgenti di ignizione funzionanti in maniera permanente (quali fiamme libere, apparecchi a gas o radiatori elettrici in funzione).

(1) Potenziale di riscaldamento globale

2. SPECIFICHE TECNICHE

2.1 Prestazioni



Modella	ENERGYLINE PRO	ENP10TAS
Potenzialità termica *	kW	36,9
Potenza elettrica assorbita*	kW	6,87
Corrente assorbita *	A	14,8
Tensione di alimentazione	V / Ph / Hz	400 V / 3N~ / 50Hz
Calibro fusibile tipo aM	A	20
Interruttore curva D	A	20
Numero compressori	/	1
Tipo di compressore	/	Scroll
Numero ventole	/	2
Potenza assorbita ventola	W	50 - 225
Velocità di rotazione dei ventilatori	RPM	600 - 1050
Ventilazione	/	Horizontal
Livello di pressione acustica (a 10 m) LpA	dB(A)	41
Collegamento idraulico	mm	63
Portata d'acqua nominale*	m ³ /h	13
Perdite di carico acqua (max.)	kPa	13,8
Dimensioni nette dell'unità (L/I/h)	mm	1482 / 485 / 1480
Peso netto dell'unità	kg	182

* Prestazioni secondo la norma di prova NF EN 14511, ripresa nel sistema di riferimento francese NF-414.
Aria asciutta 15°C - Umidità relativa 71% - Temperatura acqua in ingresso 26°C.

2. SPECIFICHE TECNICHE (segue)

2.2 Soglie di funzionamento

Per assicurare un funzionamento sicuro ed efficiente, utilizzare la pompa di calore entro le seguenti soglie di temperatura e umidità.

	Modalità riscaldamento 	Modalità Raffreddamento 
Temperatura esterna	-12°C ~ +35°C	+7°C ~ +43°C
Temperatura acqua	+12°C ~ +40°C	+8°C ~ +40°C
Umidità relativa	< 80%	< 80%
Soglia di configurazione set point	+15°C ~ +32°C	+8°C ~ +32°C



Se la temperatura o l'umidità non soddisfano le suddette condizioni, è possibile che si verifichi l'intervento di dispositivi di sicurezza che impediscano alla pompa di calore di azionarsi.



Per evitare eventuali rischi di deterioramento dei liner la temperatura massima di riscaldamento è limitata a 32°C. Hayward declina ogni responsabilità in caso di uso a temperature superiori a +32°C.

2. SPECIFICHE TECNICHE (segue)

2.3 Dimensioni

Modella: ENP10TAS

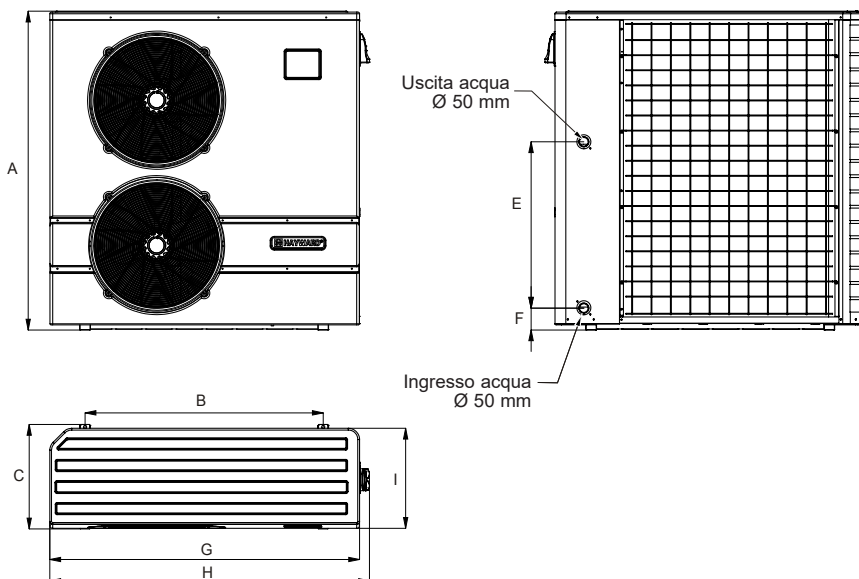

Unità: mm

Modella	ENP10TAS
Numerazione	
A	1480
B	1105
C	485
D	/
E	771,5
F	101,5
G	1437
H	1483
I	464

3. INSTALLAZIONE E COLLEGAMENTO

3.1 Schema di principio

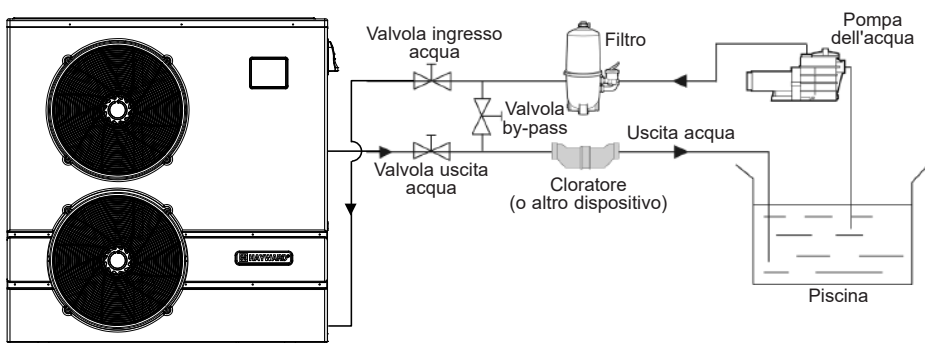

N.B.: L'unità fornita è priva di dispositivi di trattamento o di filtraggio. Gli elementi rappresentati nello schema devono essere forniti dall'installatore.

3.2 Pompa di calore



Installare la pompa di calore all'esterno e al di fuori di locali tecnici chiusi.

Scegliere un luogo preferibilmente soleggiato e al riparo da venti dominanti.

L'apparecchio deve essere perfettamente accessibile per i lavori di installazione e la successiva manutenzione.

Installare l'unità in luogo riparato e rispettare le distanze minime sottoindicate, al fine di evitare il rischio di ricircolo dell'aria o eventuali diminuzioni delle prestazioni complessive dell'unità stessa.

Unità : mm

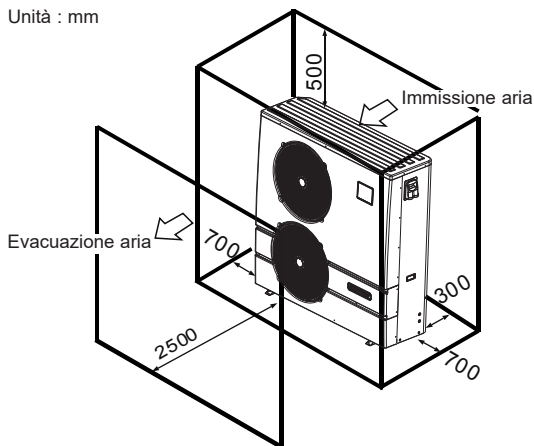

3. INSTALLAZIONE E COLLEGAMENTO (seguito)



Non collocare l'apparecchio direttamente a terra perché potrebbe rappresentare un ostacolo.

Privilegiare una posizione a terra su piedini antivibrazione.

Non usare supporti murali in condizioni suscettibili di trasmettere vibrazioni.

Non installare la pompa a calore su un supporto suscettibile di amplificare le vibrazioni prodotte dalla stessa.

Non installare la pompa in un luogo suscettibile di amplificarne il livello acustico o in cui il rumore prodotto dall'impianto rischi di disturbare i vicini.

Non usare adesivi: non sono considerati mezzi di fissaggio affidabili.

Installare preferibilmente la pompa di calore su una soletta di cemento piana e non accoppiata.

Montare la pompa di calore sui silent block forniti (viti e rondelle fornite).

Fissare l'apparecchio rispettando il serraggio indicato onde evitare rischi di incidente o danneggiamento a cose e persone.

Altra possibilità: installare la pompa di calore su supporti a terra in gomma utilizzando viti adatte (non in dotazione).

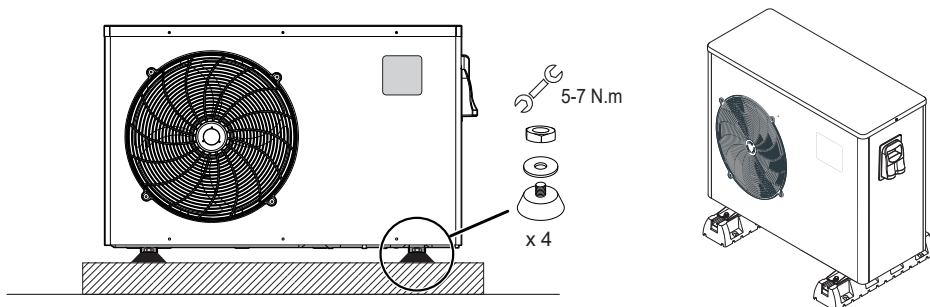

Distanza max. tra l'unità e la piscina: 15 metri.

Lunghezza totale andata/ritorno tubazioni idrauliche: 30 metri.

Isolare le tubazioni idrauliche sia interrate che non interrate.

La pompa di calore deve essere installata a una distanza minima dalla vasca conforme alla norma NF C 15-100 (ossia, per la Francia, a 3,5 m dallo specchio d'acqua) o conforme alle norme relative all'installazione vigenti negli altri paesi.

Non installare la pompa di calore in prossimità di fonti di calore.

In caso d'installazione in regioni nevose, si consiglia di proteggere la macchina per prevenire un eventuale accumulo di neve sull'evaporatore.

3. INSTALLAZIONE E COLLEGAMENTO (segue)

3.3 Collegamento idraulico

L'unità è dotata di due raccordi di unione del diametro di 50 mm. Utilizzare tubi in PVC per tubazioni idrauliche Ø 50 mm. Collegare la tubazione per l'ingresso dell'acqua dell'unità alla conduttura proveniente dal gruppo di filtraggio, quindi collegare la tubazione per lo scarico dell'acqua alla conduttura utilizzata per immettere acqua nella piscina (cf. schema seguente).

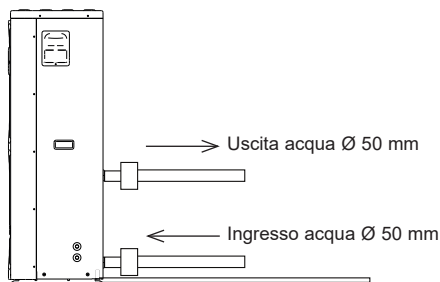

Installare una valvola by-pass tra l'ingresso e l'uscita dell'unità.



Se si utilizza un cloratore o un cloratore automatico, installare tale dispositivo dopo l'unità, al fine di proteggere il condensatore in Titanio da una concentrazione troppo elevata di prodotto chimico.



Per facilitare il drenaggio dell'unità durante la preparazione all'inverno e fornire facile accesso alle operazioni di smontaggio e manutenzione, si consiglia di installare la valvola by-pass e i raccordi di unione in dotazione in corrispondenza dell'ingresso e dell'uscita dell'unità.

3. INSTALLAZIONE E COLLEGAMENTO (segue)

3.4 Collegamento Elettrico



L'installazione elettrica e il cablaggio del presente dispositivo devono essere conformi alle norme d'installazione locali vigenti.

F	NF C15-100	GB	BS7671:1992
D	DIN VDE 0100-702	EW	EVHS-HD 384-7-702
A	ÖVE 8001-4-702	H	MSZ 2364-702/1994/MSZ 10-553 1/1990
E	UNE 20460-7-702 1993, RECBT ITC-BT-31 2002	M	MSA HD 384-7-702.S2
IRL	Wiring Rules + IS HD 384-7-702	PL	PN-IEC 60364-7-702:1999
I	CEI 64-8/7	CZ	CSN 33 2000 7-702
LUX	384-7.702 S2	SK	STN 33 2000-7-702
NL	NEN 1010-7-702	SLO	SIST HD 384-7-702.S2
P	RSIUEE	TR	TS IEC 60364-7-702



Assicurarsi che l'alimentazione elettrica disponibile e la frequenza di rete siano adeguate alla corrente operativa richiesta, tenendo in considerazione l'area di collocazione dell'unità e la corrente necessaria ad alimentare ogni altro dispositivo collegato allo stesso circuito.



ENP10TAS 400 V \sim +/- 10 % 50 Hz 3 fasi

Accertarsi che l'equilibrio delle fasi non superi il 2%

Fare riferimento allo schema dell'impianto elettrico corrispondente in appendice. La scatola di collegamento è posta sul lato destro dell'unità. Tre connessioni sono destinate all'alimentazione elettrica e due al comando della pompa di filtraggio (Asservimento).

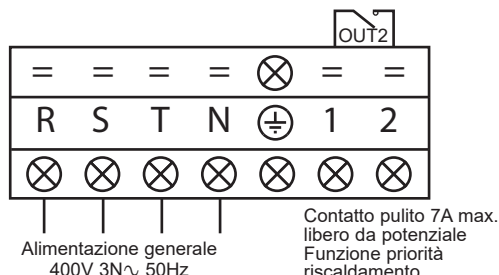

3. INSTALLAZIONE E COLLEGAMENTO (segue)



Mai utilizzare prese di corrente per l'alimentazione.

La linea di alimentazione elettrica deve essere opportunamente dotata di un dispositivo di protezione onnipolare tipo interruttore curva D e un interruttore differenziale di protezione 30mA (v. tabella seguente).

Modella		ENP10TAS
Alimentazione elettrica	V/Ph/Hz	400V 3N~ 50Hz
Calibro fusibile tipo aM	A	20 aM
Interruttore curva D	A	20 D
Sezione cavo	mm ²	5G4 5 x 4



Utilizzare un cavo di alimentazione tipo RO2V/R2V o equivalente.



Le sezioni del cavo sono fornite per una lunghezza massima di 25 m, ma devono comunque essere controllate e adattate a seconda delle condizioni d'installazione.



Staccare sempre l'alimentazione principale prima di aprire il quadro di comando elettrico.

3.5 Primo avviamento

Procedura di avviamento - dopo aver completato l'installazione, attenersi alla seguente procedura:

- 1) Ruotare manualmente i ventilatori per verificarne la libertà di movimento e per assicurarsi che l'elica sia correttamente fissata all'albero motore.
- 2) Assicurarsi che l'unità sia correttamente collegata alla fonte di alimentazione principale (v. schema dell'impianto elettrico in appendice).
- 3) Attivare la pompa di filtraggio.
- 4) Verificare che tutte le valvole dell'acqua siano aperte e che l'acqua fluisca nell'unità prima di avviare qualsiasi processo di riscaldamento o raffreddamento.
- 5) Verificare che la manichetta per lo scarico della condensa sia correttamente collegata e che non vi sia ostacolo al suo funzionamento.
- 6) Attivare l'alimentazione elettrica destinata all'unità, quindi premere il pulsante ON/OFF  sul pannello di controllo.
- 7) Assicurarsi che non vi sia alcun codice ALLARME visualizzato sullo schermo quando l'unità è accesa (v. Guida alla Risoluzione dei Problemi).

3. INSTALLAZIONE E COLLEGAMENTO (segue)

- 8) Definire la portata dell'acqua agendo sulla valvola by-pass (v. § 3.6 e 2.1) secondo le indicazioni riportate sulla targhetta identificativa del modello, fino a ottenere una differenza nella temperatura dell'acqua in Ingresso/ Uscita di 2°C.
- 9) Dopo alcuni minuti di utilizzo, assicurarsi che l'aria in uscita sia più fredda (5-10°C).
- 10) Ad unità avviata, spegnere la pompa di filtraggio. L'unità si spegne automaticamente e viene visualizzato il codice errore E03.
- 11) Lasciare l'unità e la pompa piscina in funzione per 24 ore al giorno fino a quando l'acqua non raggiunge la temperatura desiderata. Quando la temperatura dell'acqua in ingresso raggiunge il valore predefinito, l'unità si spegne. L'unità si riavvia automaticamente (fino a quando la pompa della piscina rimane in funzione) quando la temperatura dell'acqua scende di 0,5°C rispetto alla temperatura impostata.

Interruttore di portata - L'unità è dotata di un interruttore di portata che ne regola l'accensione, quando la pompa di filtraggio della piscina è in funzione, e lo spegnimento, quando la pompa di filtraggio della piscina è fuori servizio. Se il livello dell'acqua è troppo basso, il codice d'allarme E03 viene visualizzato sul regolatore (v. § 6.4).

Temporizzazione - L'unità è dotata di un dispositivo di temporizzazione con ritardo di 3 minuti atto a proteggere i componenti del circuito di controllo e a prevenire avvii intempestivi e interferenze concernenti il contattore. Questa funzione riavvia automaticamente l'unità circa 3 minuti dopo ogni interruzione del circuito di controllo. Tale dispositivo si attiva anche in seguito a una breve interruzione di corrente.

Sequenzimetro - Le unità trifase sono dotate di un sequenzimetro che garantisce che il senso di rotazione del compressore sia corretto. Se l'unità non parte, controllare lo stato del sequenzimetro situato nella scatola di comando.

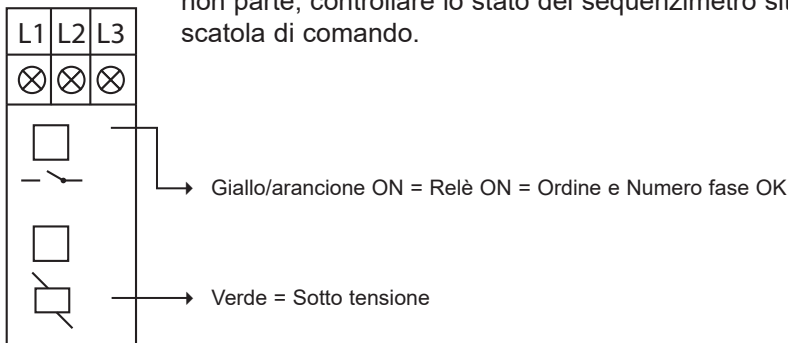

3. INSTALLAZIONE E COLLEGAMENTO (segue)

3.6 Regolazione della portata d'acqua

Tenendo aperte le valvole, regolare la valvola by-pass in modo tale da ottenere una differenza di 2° C tra la temperatura dell'acqua in ingresso e la temperatura dell'acqua in uscita (v. schema di principio § 3.1). È possibile accertarsi della corretta regolazione verificando la temperatura dell'acqua in ingresso e in uscita visualizzata sul pannello di controllo.

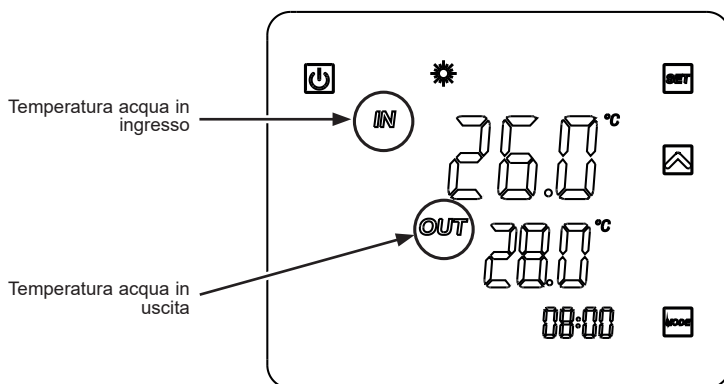

N.B.: L'apertura della valvola by-pass genera una portata minore e un conseguente aumento del ΔT .

La chiusura della valvola by-pass genera una portata maggiore e una conseguente diminuzione del ΔT .

4. INTERFACCIA UTENTE

4.1 Presentazione generale

L'unità è dotata di un pannello di comando digitale touch screen collegato elettricamente e preimpostato in fabbrica in modalità riscaldamento.

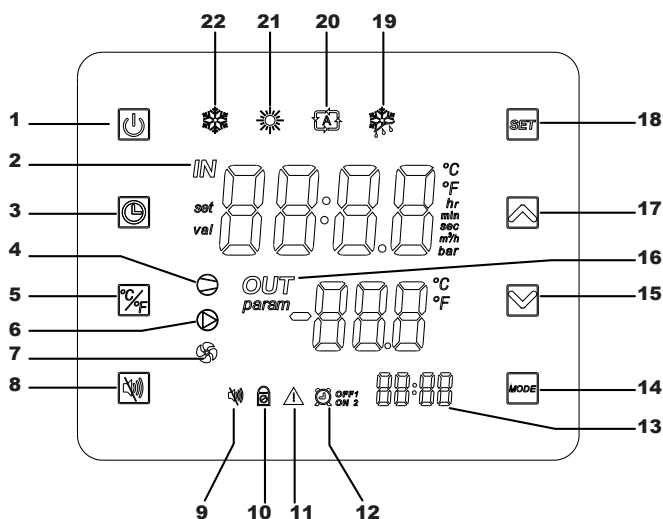

Legenda

1		ON/OFF
2		Ingresso acqua
3		Impostazione ora e Timer
4		Compressore ON
5		Conversione °C/°F
6		Contatto a secco OUT2
7		Fan ON
8		Modalità silenzioso
9		Spia modalità silenzioso
10		Schermo bloccato
11		Allarme

12		Timers 1 e 2
13		Ora Timers
14		Selezione modalità
15		Giù / Riduci
16		Uscita acqua
17		Su / Aumenta
18		Salva / Impostazioni
19		Modalità sbrinamento
20		Modalità automatica
21		Modalità Riscaldamento
22		Modalità Raffreddamento

4. INTERFACCIA UTENTE (segue)

Modalità OFF

Quando l'unità è in stand-by (Modalità OFF), viene visualizzata sul regolatore la dicitura "OFF".

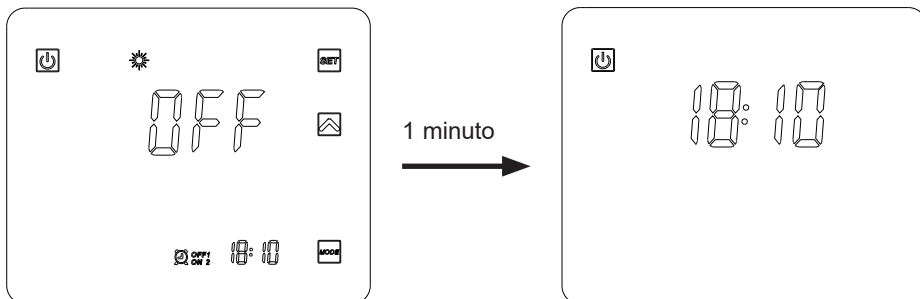

Modalità ON

Quando l'unità è in funzione o in fase di impostazione (Modalità ON), viene visualizzata sullo schermo del regolatore la temperatura dell'acqua in ingresso e in uscita.

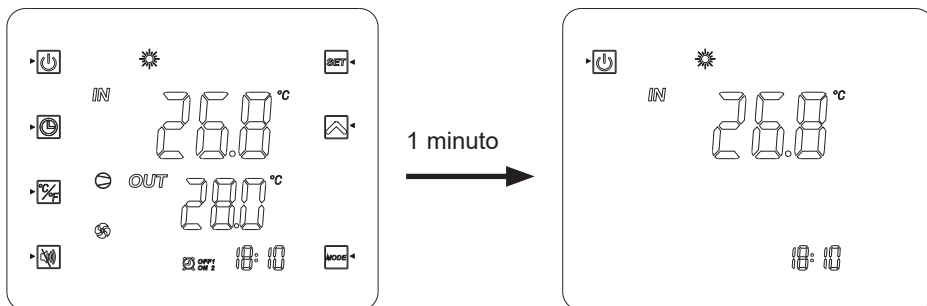











4. INTERFACCIA UTENTE (segue)

Al termine delle impostazioni, premere  per confermare.

Registrazione automaticamente le impostazioni dopo 20s senza azione.

4.2 Configurazione dell'orologio

Se il display è stand-by premere il pulsante .









- 1) Premere  per far apparire il simbolo .
- 2) Premere , le ore lampeggiano. Impostare le ore con i pulsanti  .
- 3) Premere  e impostare i minuti usando i pulsanti  .
- 4) Confermare con .

4.3 Configurazione della funzione timer











La configurazione di questa funzione è necessaria se si desidera azionare l'unità per un periodo più breve rispetto a quello impostato tramite l'orologio che regola l'azionamento della pompa di filtraggio. In questo modo, è possibile ritardare l'avvio, anticipare l'arresto o impedire l'avviamento dell'unità durante una determinata fascia oraria (ad esempio di notte).

È possibile programmare fino a 2 Timer Partenza (ON1 e ON2) e 2 Timer Stop (OFF1 e OFF2).

Programmazione timer 1 – Avvio

- 1) Premere  per 2s, il Timer ON1  ¹ lampeggia (*).
- 2) Premere  per impostare le ore usando i pulsanti  .
- 3) Premere  per impostare i minuti usando i pulsanti  .
- 4) Confermare con .

Programmazione Timer 1 – Fine

- 1) Premere  per 2s, il Timer ON1  ¹ lampeggia (*).
Premere 1 volta , il Timer OFF1  ^{OFF1} lampeggia.
- 2) Premere  per impostare le ore usando i pulsanti  .
- 3) Premere  per impostare i minuti usando i pulsanti  .
- 4) Confermare con .

(*) Per accedere direttamente al Timer ON2  ^{ON 2}, premere e tenere premuto  per 2s, quindi premere 2 volte .



4. INTERFACCIA UTENTE (segue)

Programmazione Timer 1



Dopo aver impostato il Timer 1 si accede direttamente all'impostazione del

Timer 2:  ON_2 e  OFF_2 .



Procedere come per il Timer 1.

Nota: Per accedere direttamente al Timer ON2 , premere e tenere premuto  per 2s, quindi premere 2 volte .

Cancellazione Timers (Avvio e Fine)

1) Premere  per 2s, il Timer ON1  lampeggia (*).

2) Premere , le ore lampeggiano.



3) Premere  per cancellare il Timer .



4) Confermare con .

5) Premere  per 2s, il Timer ON1  lampeggia.

Premere 1 volta , il Timer  lampeggia. (*)

6) Premere , le ore lampeggiano.

7) Premere  per cancellare il Timer .

(*) Per accedere ai Timer 2  o , seguire le indicazioni fornite ai punti 1) o 4), quindi premere 2 volte . Procedere come indicato in precedenza.

4.4 Selezione della modalità operativa

In modalità "OFF" oppure "ON"

Premere il tasto  per cambiare modalità: raffreddamento, riscaldamento o automatico.

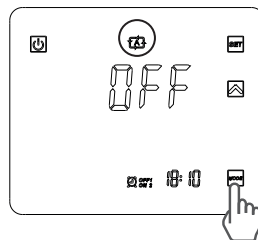
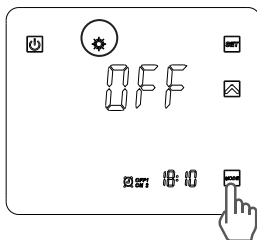
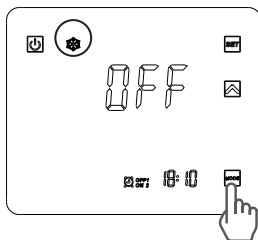



Se la pompa di calore si trova in solo riscaldamento o solo raffreddamento modalità, il cambio di modalità non è possibile.

4. INTERFACCIA UTENTE (segue)

4.5 Configurazione e visualizzazione set point



(Temperatura dell'acqua desiderata)

Se il pulsante  non appare sullo schermo, premere .

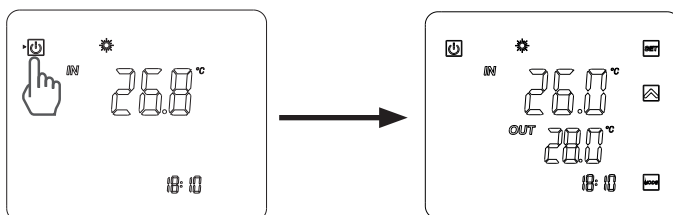
(Che il dispositivo sia in funzione o meno, per visualizzare il set point basterà premere il pulsante .)



In modalità “OFF” e in modalità “ON”

Visualizzare il set point premendo , quindi impostare il set point desiderato premendo  o .



La configurazione viene effettuata con una precisione di regolazione di 0,5 °C.



Si raccomanda di non oltrepassare la temperatura di 30°C al fine di evitare di alterare i liner.

4.6 Blocco e sblocco del touch screen

Tenere premuto il pulsante ON/OFF  per 5 sec. fino all'emissione di un segnale sonoro (bip) e alla visualizzazione del simbolo .

Per sbloccare, tenere premuto  per 5 sec. fino all'emissione di un segnale sonoro (bip) e alla visualizzazione del simbolo .

4. INTERFACCIA UTENTE (segue)

4.7 Regolazione modalità silenzio

La presente funzione consente di utilizzare la pompa di calore a una velocità di rotazione dei ventilatori ridotta, pari a 600 giri/min. per 8 ore max., in modo tale da limitare i rumori durante le ore notturne o diurne a seconda della collocazione della pompa rispetto alle abitazioni vicine e/o alla vasca.



La funzione può essere Attivata/Disattivata manualmente o tramite un timer.

Attivazione manuale

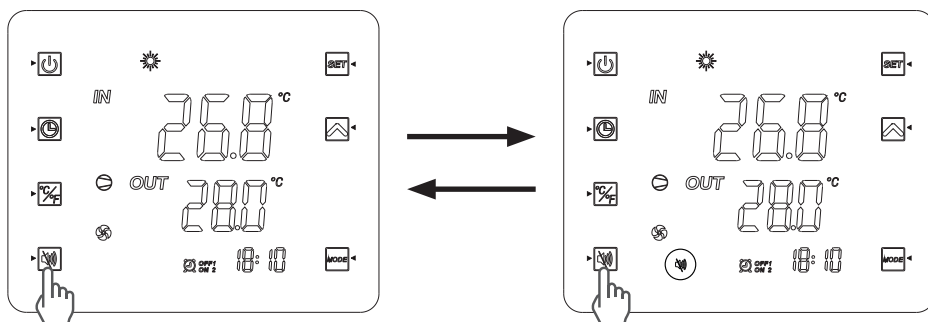
- 1) Premere il pulsante .
- 2) Sul display appare la seguente schermata, la modalità Silenzioso è attivata per 8 ore.
- 3) La velocità di rotazione dei ventilatori si riduce progressivamente tale per un totale di 8 ore max.
- 4) Dopo 8 ore di funzionamento a velocità ridotta la funzione si disattiva automaticamente e i ventilatori ricominciano a funzionare a una velocità dipendente dalla temperatura dell'aria esterna



Disattivazione manuale

- 1) Premere il pulsante .
- 2) La spia  non è più visualizzata sullo schermo: la modalità Silenzioso è disattivata.
- 3) La velocità di rotazione dei ventilatori è regolata automaticamente in base alla temperatura dell'aria esterna.

4. INTERFACCIA UTENTE (segue)



Programmazione della modalità SILENZIO

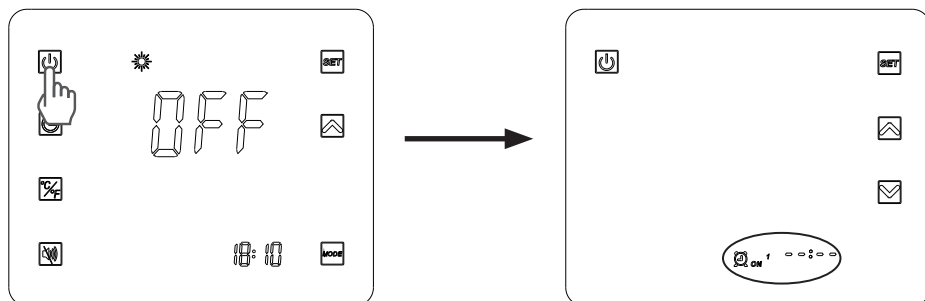

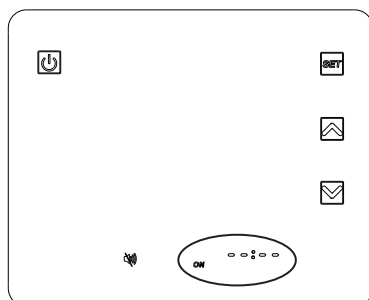

1) Premere  per 2s : il Timer ON1  ON 1 lampeggia.



2) Premere 4 volte  per visualizzare la seguente schermata.









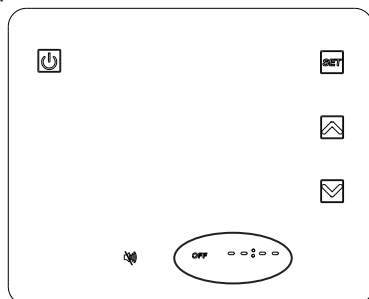

3) Premere , le ore lampeggiano. Impostare l'ora di inizio usando le frecce  .

4) Premere , i minuti lampeggiano. Impostare i minuti di inizio usando le frecce  . Confermare con .

5) Premere  per impostare l'ora di fine: l'indicazione OFF lampeggia.



4. INTERFACCIA UTENTE (segue)

- 6) Premere , Premere , le ore lampeggiano. Impostare l'ora di fine usando le frecce  .
- 7) Premere , i minuti lampeggiano. Impostare i minuti di fine usando le frecce  . Confermare con .
- 8) Premere  per tornare alla schermata precedente.
Le indicazioni ON-OFF vengono visualizzate come segue.

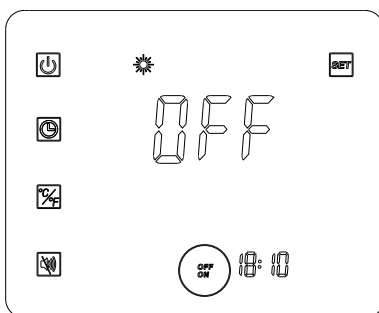

Nota : L'ora può essere impostata solo a intervalli di 10 minuti.

Una volta impostata, la modalità SILENCE rimane la modalità predefinita 7 giorni su 7.

5. MANUTENZIONE E SVERNAMENTO

5.1 Manutenzione

Per garantire la longevità e il corretto funzionamento dell'Unità di Riscaldamento a Pompa di Calore per Piscine, le presenti operazioni di manutenzione devono essere effettuate 1 volta all'anno.

- La manutenzione e le riparazioni dell'apparecchio devono essere effettuati da un professionista autorizzato conformemente allo stato dell'arte e ai testi regolamentari vigenti nel paese in cui l'apparecchio è installato (v. § 3.4). In caso di intervento sul circuito frigorifero, il professionista deve essere in possesso di un'attestazione di capacità alla manipolazione di fluidi frigorigeni.
- Controllare il cavo di alimentazione. Se il cavo di alimentazione è danneggiato, deve essere sostituito dal produttore, dal suo servizio post-vendita o da una persona qualificata e abilitata.
- Verificare il collegamento dell'apparecchio alla terra e la sua continuità.
- Pulire l'evaporatore con una spazzola morbida, un getto di aria compressa o con acqua (**Attenzione: non utilizzare in nessun caso idropultrici**).
- Controllare che lo scarico della condensa avvenga correttamente.
- Controllare che i collegamenti idraulici e quelli elettrici siano serrati correttamente.
- Controllare la tenuta idraulica del condensatore.
- Far controllare la tenuta del circuito frigorifero al rilevatore di perdite da un **professionista autorizzato**.



Prima di eseguire qualsiasi operazione di manutenzione, assicurarsi che l'unità sia scollegata da ogni fonte di corrente elettrica. Le operazioni di manutenzione devono essere effettuate esclusivamente da personale qualificato e abilitato alla manipolazione di fluidi frigorigeni.

5.2 Svernamento

- Mettere l'unità in Modalità "OFF".
- Interrompere l'alimentazione dell'unità.
- Svuotare il condensatore tramite l'apposito scolo per evitare eventuali rischi di degrado. (elevato rischio di congelamento).
- Chiudere la valvola by-pass e svitare i raccordi di unione ingresso/uscita.
- Eliminare dal condensatore l'acqua stagnante residua servendosi di una pistola ad aria compressa.
- Ostruire l'ingresso e l'uscita dell'acqua dell'unità, al fine di evitare l'eventuale intrusione di corpi estranei.
- Coprire l'unità con l'apposito telo per l'inverno.



Qualsiasi danno causato da una protezione invernale inadeguata comporterà l'annullamento della garanzia.

6. APPENDICI

6.1 Schemi Elettrici

ENP10TAS

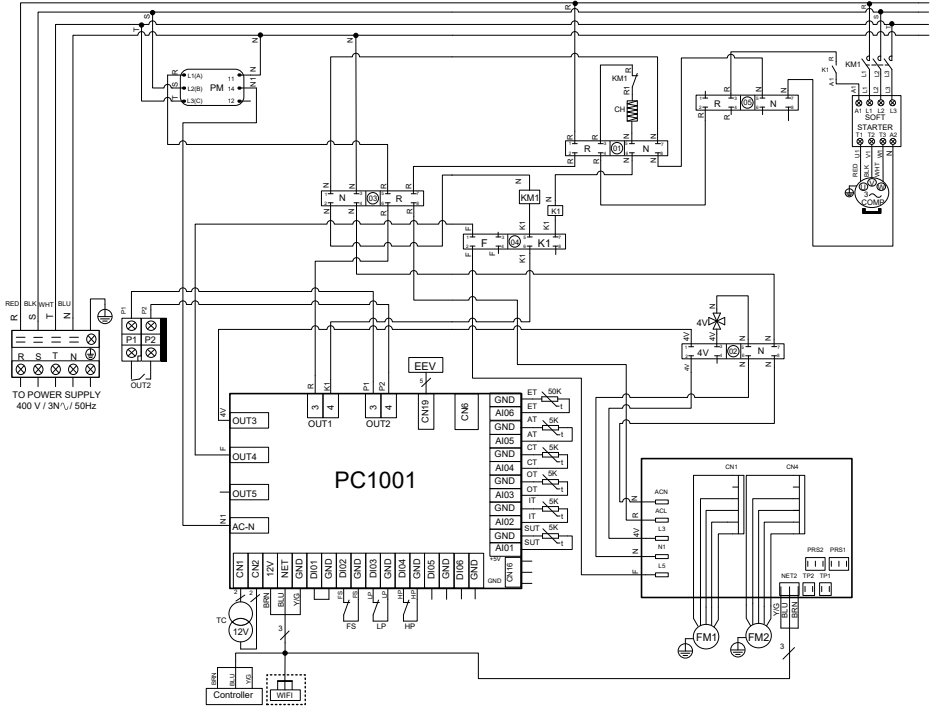

LEGENDA:

- AT : SONDA TEMPERATURA ARIA
- COMP : COMPRESSORE
- CT : SONDA TEMPERATURA EVAPORATORE
- EEV : REGOLATORE DI PRESSIONE ELETTRONICO
- FM1-2 : MOTORE VENTOLA
- FS : RILEVATORE ACQUA
- HP : PRESSOSTATO ALTA PRESSIONE
- IT : SONDA TEMPERATURA ACQUA IN INGRESSO
- LP : PRESSOSTATO BASSA PRESSIONE

- OT : SONDA TEMPERATURA ACQUA IN USCITA
- SUT : SONDA TEMPERATURA ASPIRAZIONE
- TC : TRASFORMATORE 230V~ / 12V~
- 4V : VALVOLA 4 VIE
- KM1 : CONTATTORE DI POTENZA COMPRESSORE
- PM : SEQUENZIMETRO
- CH1 : RESISTENZA CARTER
- ET : SONDA TEMPERATURA DI MANDATA
- OUT2 : CONTATTO PULITO LIBERO DA POTENZIALE 7A MAX.
- [] : OPTIONAL

6. APPENDICI (segue)

6.2 Collegamenti priorità riscaldamento pompa trifase

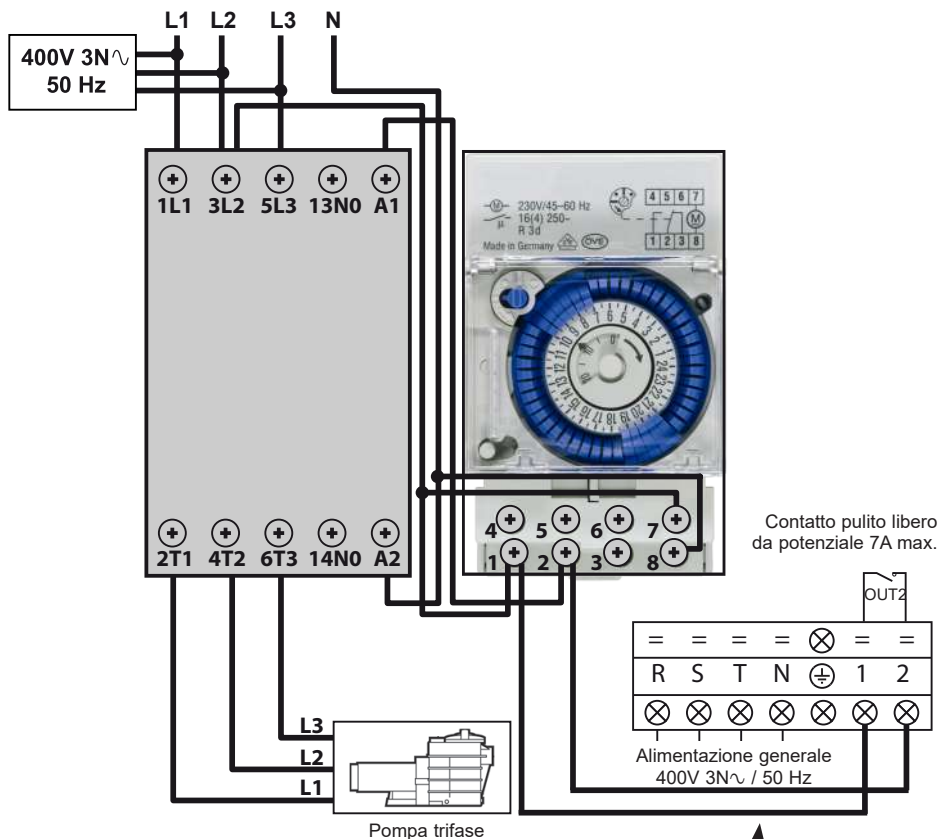

I morsetti 1 e 2 offrono un contatto pulito libero da potenziale, senza polarità 230 V~ / 50 Hz.

Collegare i morsetti 1 e 2 come indicato nello schema di cablaggio di cui sopra per garantire il funzionamento della pompa di filtraggio per un ciclo di 2 min. ogni ora qualora la temperatura all'interno della vasca fosse inferiore al set point impostato.

 Non collegare l'alimentazione della pompa di filtraggio direttamente ai morsetti 1 e 2.



Pagina lasciata intenzionalmente bianca

6. APPENDICI (segue)

6.3 Esplosa e parti di ricambio

ENP10TAS

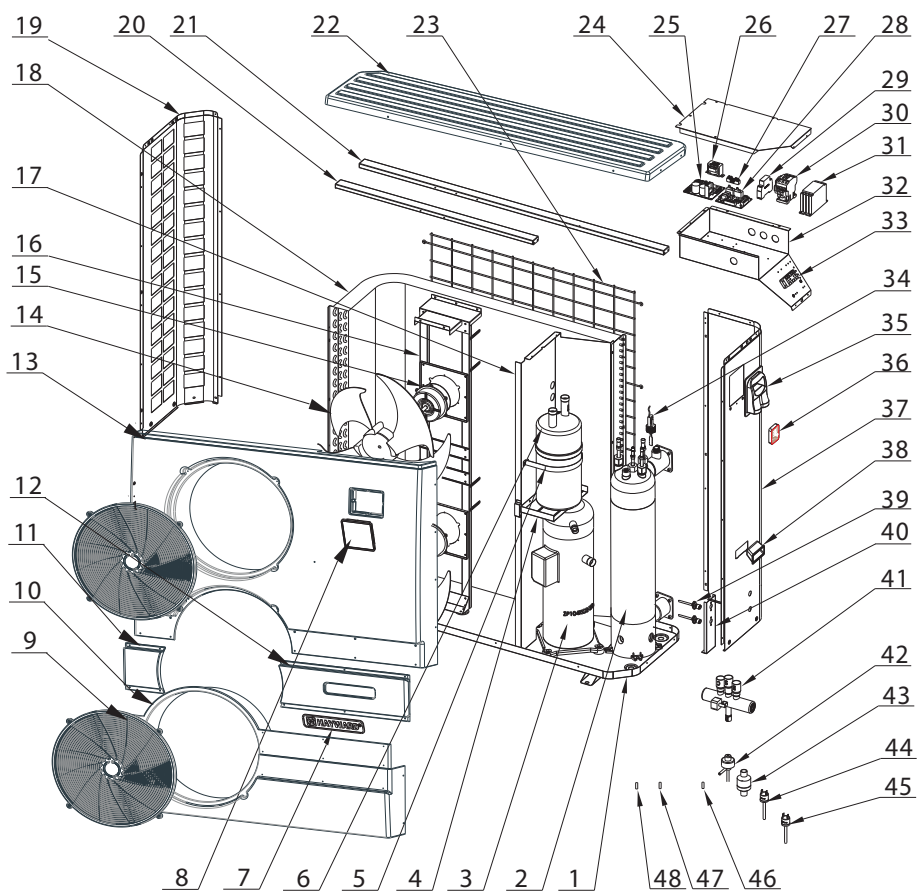

6. APPENDICI (segue)

ENP10TAS

Num.	Rif.	Designazione	Num.	Rif.	Designazione
1	HWX32005210049	Fondo	27	HWX20003909	Morsettiera 2 connessioni
2	HWX32005120009	Condensatore Titanio/ PVC	28	HWX950531014516	Scheda elettronica
3	HWX20000110153	Compressore	29	HWX200036023	Controllo di fase
4	HWX32027210011	Supporto Serbatoio liquido	30	HWX20000360209	Contattore compressore Tri
5	HWX32027210013	Fascetta	31	HWX20000360092	Avviatore elettronico TRI
6	HWX35141402	Serbatoio liquido	32	HWX32005210054	Quadro elettrico
7	HWX20000230596	Logo Hayward	33	HWX20000390180	Morsettiera 5 connessioni Tri
8	HWX95005010018	Regolatore LED	34	HWX200036005	Rilevatore portata acqua
9	HWX32020220001	Griglia di protezione ventilatore	35	HWX32009220032	Portello d'accesso scatola elettrica
10	HWX32005220002	Pannello anteriore inferiore	36	HWX95005010014	Modulo Wi-Fi
11	HWX32005220005	Pannello decorativo sinistro	37	HWX32005210060	Pannello destro
12	HWX32005220004	Pannello decorativo destro	38	HWX32008220037	Maniglia
13	HWX32005220001	Pannello anteriore superiore	39	HWX20000140353	Presa della pressione AP&BP
14	HWX20000270025	Elica ventilatore	40	HWX32019210038	Piastra Supporto prese HP/LP
15	HWX20000330361	Motore DC	41	HWX20011488	Valvola 4 vie
16	HWX32005210058	supporto motore	42	HWX20000140338	Riduttore di pressione elettronico
17	HWX32005210065	Pannello di separazione	43	HWX20041455	Filtro
18	HWX32005120008	Evaporatore	44	HWX20003603	Pressostato Bassa pressione
19	HWX32005210051	Pannello sinistro	45	HWX20013605	Pressostato Alta pressione
20	HWX32005220055	Tirante corto	46/47	HWX20003242	Sonda temperatura evaporatore/aria/acqua
21	HWX32005210056	Tirante ampio	48	HWX20003223	Sonda compressore 50 kΩ
22	HWX32005220003	Pannello superiore	*49*	HWX20000240208	Copertura per svernamento
23	HWX32005210063	Protezione evaporatore	*50*	HWX200026009	O-ring ID 48 - Spess. 5 mm
24	HWX32005210053	Pannello di protezione scatola elettrica	*51*	HWX200026061	O-ring ID 43 - Spess. 3,4 mm
25	HWX950531024107	Modulo DC Inverter	*52*	HWX20003214	Resistenza carter
26	HWX200037003	Trasformatore 230V~ - 12V~	*53*	HWX20002625	Silent block

6. APPENDICI (segue)



6.4 Guida alla Risoluzione dei Problemi

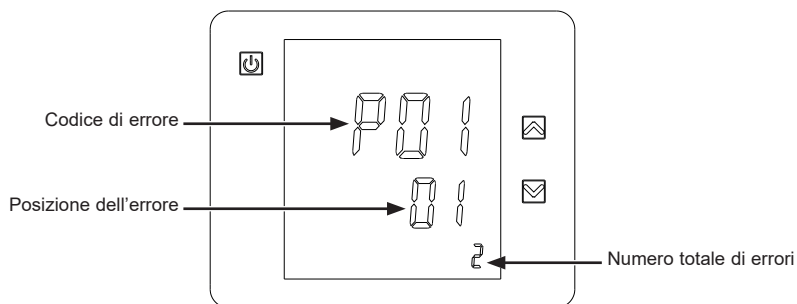

Alcune delle presenti operazioni devono essere effettuate da un tecnico autorizzato.

In caso di problemi sullo schermo compaiono le seguenti indicazioni:



Nel caso in cui vengano rilevati più errori, per passare da un codice errore all'altro premere  o . Fare riferimento alla tabella seguente.

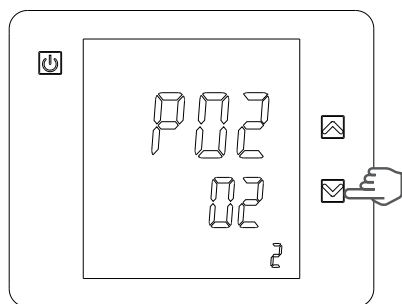

6. APPENDICI (segue)

Malfunzionamento	Codice errore	Descrizione	Soluzione
Guasto sonda temperatura acqua in ingresso	P01	Il sensore è aperto o si è verificato un corto circuito.	Controllare o sostituire il sensore.
Guasto sonda acqua in uscita	P02	Il sensore è aperto o si è verificato un corto circuito.	Controllare o sostituire il sensore.
Guasto sonda antigelo	P05	Il sensore è aperto o si è verificato un corto circuito.	Controllare o sostituire il sensore.
Guasto sonda temperatura esterna	P04	Il sensore è aperto o si è verificato un corto circuito.	Controllare o sostituire il sensore.
Guasto sonda di aspirazione compressore	P07	Il sensore è aperto o si è verificato un corto circuito.	Controllare o sostituire il sensore.
Differenza di temperatura tra acqua in ingresso e acqua in uscita troppo ampia	E06	Volume portata d'acqua insufficiente, differenza pressione acqua troppo bassa/troppo elevata	Controllare il volume della portata d'acqua o se il sistema è ostruito da corpi estranei.
Protezione antigelo Modalità raffreddamento	E07	Portata acqua in uscita troppo bassa.	Controllare il volume della portata d'acqua o il sensore della temperatura dell'acqua in uscita.
Protezione antigelo livello 1	E19	Temperatura ambiente o temperatura dell'acqua in ingresso troppo bassa.	
Protezione antigelo livello 2	E29	Temperatura ambiente o temperatura dell'acqua in ingresso ancora più bassa.	
Protezione alta pressione	E01	Pressione del circuito frigorifero troppo alta, portata dell'acqua troppo bassa, evaporatore ostruito o flusso d'aria insufficiente.	Controllare il pressostato alta pressione e la pressione del circuito frigorifero. Controllare il volume della portata d'acqua o il flusso d'aria. Controllare il corretto funzionamento dell'interruttore di portata. Controllare l'apertura delle valvole di ingresso/uscita acqua. Controllare la regolazione del by-pass.
Protezione bassa pressione	E02	Pressione del circuito frigorifero troppo bassa, flusso d'aria insufficiente o evaporatore ostruito.	Controllare il pressostato bassa pressione e la pressione del circuito frigorifero per individuare eventuali perdite. Pulire la superficie dell'evaporatore. Controllare la velocità di rotazione della ventola. Controllare che l'aria circoli liberamente attraverso l'evaporatore.
Guasto sensore di portata	E03	Portata d'acqua insufficiente o sensore in cortocircuito o difettoso	Controllare la portata d'acqua e accertarsi che la pompa e il sensore di portata non abbiano subito danni.
Guasto nel circuito di comunicazione	E08	Guasto del dispositivo di controllo a LED o del collegamento dei circuiti stampati.	Controllare il collegamento dei cavi NET e NET 1.
Il compressore non parte	E08	Fase mancante o ordine fasi non corretto	accertarsi della presenza delle 3 fasi modificare l'ordine delle fasi sulla morsettiera di collegamento elettrico della pompa di calore

6. APPENDICI (segue)

6.5 Garanzia

CONDIZIONI DI GARANZIA

Tutti i prodotti HAYWARD sono garantiti contro tutti i difetti di fabbricazione o di materiale per un periodo di due anni dalla data di acquisto. Le eventuali richieste di garanzia dovranno essere accompagnate dalla prova di acquisto comprovante detta data. Si raccomanda pertanto di conservare la fattura.

La garanzia HAYWARD è limitata alla riparazione o alla sostituzione, a discrezione della stessa HAYWARD, dei prodotti difettosi solo ed esclusivamente in caso di normale utilizzo e in conformità alle prescrizioni riportate nel manuale d'uso del prodotto; sarà altresì riconosciuta valida, qualora il prodotto in questione non sia stato in alcun caso alterato ed utilizzato esclusivamente in abbinamento a parti e componenti HAYWARD. Gli eventuali danni dovuti a gelo e ad attacchi di agenti chimici non sono coperti da garanzia.

Ogni altra spesa (trasporto, manodopera...) è esclusa dalla garanzia.

HAYWARD declina ogni responsabilità per danni, diretti o indiretti, riconducibili a installazione, collegamento o utilizzo non corretti del prodotto.

Per richiedere un intervento in garanzia e la riparazione o la sostituzione di un componente, rivolgersi ad un rivenditore autorizzato. Salvo previo accordo scritto, gli eventuali resi saranno respinti.

I componenti soggetti ad usura non sono coperti dalla garanzia.

6.6 Fine vita dell'apparecchio



Il simbolo del cestino sbarrato relativo al trattamento e al recupero dei rifiuti elettrici ed elettronici significa che in nessun caso i prodotti devono essere gettati insieme ai rifiuti domestici, agli ingombranti o in discarica.

A fine vita, l'apparecchio deve essere messo nella raccolta differenziata per il riciclaggio o il recupero. Per questa tipologia di prodotti è previsto un circuito specifico di recupero nei paesi dell'Unione europea e in Norvegia.

Contattare l'installatore o il rappresentante locale per la raccolta, lo smantellamento e il riciclaggio di questo apparecchio.

Il ritrattamento del liquido refrigerante, dell'olio e degli altri pezzi deve essere realizzato da un professionista qualificato e autorizzato nel rispetto delle legislazioni locali e nazionali in vigore.

Se il prodotto contiene pile su cui è raffigurato questo simbolo, significa che le pile possono contenere sostanze nocive o inquinanti. In questo caso, smaltire le pile in un punto di raccolta per pile esauste.

ENERGYLINE PRO

VARMEPUMPE TIL SVØMMEBASSENG



ENP10TAS

Installerings- og brukerveiledning

INNHold

1. GENERELLE FORHOLDSREGLER - SIKKERHET	1
2. SPESIFIKASJONER	4
2.1 Varmepumpens ytelse	4
2.2 Driftsområde	5
2.3 Dimensjoner	6
3. INSTALLERING OG TILKOBLING	7
3.1 Skjematisk diagram	7
3.2 Varmepumpe	7
3.3 Vanntilkobling	9
3.4 Elektrisk tilkobling	10
3.5 Førstegangs oppstart	11
3.6 Innstilling av vannstrømmen	13
4. BRUKERGRENSESNIITT	14
4.1 Oversikt	14
4.2 Innstilling av tid	16
4.3 Innstilling av Timer	16
4.4 Valg av driftsmodus	17
4.5 Låse og låse opp berøringsskjermen	18
4.6 Innstilling og visning av settpunkt	18
4.7 Stillemodusinnstilling	19
5. VEDLIKEHOLD OG VINTERKLARGJØRING	22
5.1 Vedlikehold	22
5.2 Vinterklargjøring	22
6. VEDLEGG	23
6.1 Koblingskjemaer	23
6.2 Kobling med prioritet på trefaset varmpumpe	24
6.3 Sprengskisse og reservedeler	26
6.4 Veiledning for feilsøking	28
6.5 Garanti	30
6.6 Apparatet ved endt levetid	30

Vennligst les nøye og ta vare på for fremtidig referanse.

Dette dokumentet må være levert til svømmebassengets eier, og må oppbevares på et trygt sted.

1. GENERELLE FORHOLDSREGLER - SIKKERHET

Takk for at du kjøpte denne Hayward varmpumpen til svømmebasseng. Dette produktet er blitt fremstilt i samsvar med strenge fabrikkasjonsstandarder for å tilfredsstille de påkrevde kvalitetsnivåene. Denne veiledningen inneholder alle nødvendige opplysninger angående installasjon, løsning av driftsproblemer og vedlikehold. Les veiledningen nøye før du åpner enheten eller utfører vedlikeholdsoperasjoner på den. Fabrikanten av dette produktet vil ikke i noen tilfeller bli holdt ansvarlig i tilfelle skade på brukeren eller forringelse av enheten som en følge av eventuelle feil ved installasjon, løsning av driftsproblemer eller unødvendig vedlikehold. Det er svært viktig at instruksene i denne veiledningen blir nøye etterfulgt på ethvert tidspunkt.

Etter å ha lest denne brukerveiledningen, ta vare på den for senere referanse.

Godkjent personell

- Installasjon, elektriske koblinger, vedlikehold og reparasjon av dette apparatet skal gjøres av godkjent fagperson i overensstemmelse med gjeldende lovtekster og etter de faglige regler som gjelder i landet der apparatet er installert (jf. § 3.4). For ethvert arbeid som skal gjøres på kjølekretsløpet skal fagpersonen være godkjent for arbeid som berører kjølevæsker.
For Frankrike:
 - Lavspennings- elektrisk installasjon i overensstemmelse med NF-C 15-100.
 - Lovverk om håndtering av kjølevæsker: Forskrift 2007/737 med påfølgende forordninger om bruk.

Betingelser for installering

- Prøv ikke å installere apparatet på egenhånd.
- Produktet er utelukkende beregnet på bruk i hjemmet og installasjon utendørs. Luften som slippes ut av produktet må kunne sirkulere fritt, og skal ikke brukes til andre formål som for eksempel oppvarming eller nedkjøling av et rom eller en bygning.
- Denne varmpumpen varmer opp bassengvannet og holder temperaturen jevn. Ikk bruk til andre formål.
- Kontroller strømledningen. Dersom strømledningen er ødelagt, må den byttes ut av fabrikanten, dennes serviceavdeling eller av en kvalifisert og godkjent fagperson.
- Apparatet skal jordes kontinuerlig, og dette er obligatorisk. Jordingsledningen skal være lenger enn de andre for å forebygge elektrisk støt dersom kableen rives ut. Den elektriske installasjonen skal være utstyrt med en 30 mA differensialbeskyttelse (cf § 3.4).
- Om disse anbefalingene ikke følges blir garantien ugyldig.

1. GENERELLE FORHOLDSREGLER (fortsetter)

Råd når det gjelder vedlikehold

Vedlikeholdsoperasjonene må utføres en gang i året for å sikre lang levetid og god drift av varmepumpen.

- Vedlikehold og drift må utføres til anbefalte tidspunkt, som oppgitt i denne brukerveiledningen.
- Bruk kun originale reservedeler.
- Kontroller strømledningen. Dersom strømledningen er ødelagt, må den byttes ut av fabrikanten, dennes serviceavdeling eller av en kvalifisert og godkjent fagperson.
- Sjekk at apparatet er jordat kontinuerlig.
- Rengjør fordampere med en myk børste eller med en luft- eller vannstråle (**NB! Bruk aldri høytrykksspyler**).
- Kontroller evakuering av kondensat.
- Kontroller at elektriske og hydrauliske koblinger sitter godt
- Kontroller vanntettheten til kondensatoren.
- La en kvalifisert fagmann sjekke tettheten på kjølekretsen ved hjelp av en lekkasje-detektor.



Før alt vedlikehold må varmepumpen være frakoblet alle strømkilder. Vedlikeholdsoperasjoner skal bare utføres av personell som er kvalifisert til å håndtere kuldemedier.

Instruksjoner for overvintring

- Sett varmepumpen i "OFF"-modus.
- Slå av varmepumpens strømforsyning.
- Tøm kondensatoren ved hjelp av tømmeventilen for å unngå fare for degradering. (høy risiko for frost).
- Lukk bypassventilen og skru løs koblingsdelene til vanninnløp/vannutløp.
- Fjern maksimalt med stillestående vann som er igjen i kondensatoren ved hjelp av en blåsepistol.
- Forsegle varmepumpens vanninnløp og vannutløp for å hindre at fremmedlegemer kommer seg inn.
- Dekk til varmepumpen med vinterbelegget som er tiltenkt dette formålet.



Alle skader som er forårsaket av uriktig vinterklargjøring vil ugyldiggjøre garantien.

1. GENERELLE FORHOLDSREGLER (fortsetter)

Bruksbetingelser

Dette apparatet kan brukes av barn over 8 år samt av personer med reduserte fysiske, sensorielle eller mentale evner, eller av personer uten erfaring eller kunnskap, dersom disse personene er under korrekt overvåking eller dersom de har fått instruksjoner om sikker bruk av apparatet, og dersom det blir tatt hensyn til all risiko.

Barn skal ikke leke med dette apparatet.

Rengjøring og vedlikehold skal ikke gjøres av barn som ikke er under overvåking.

Dette produktet inneholder kjølegassen R410A

Dette produktet inneholder fluorholdige klimagasser som er gjeldende under Kyoto-protokollen. Disse gassene må ikke frigjøres i atmosfæren.

GWP-verdi⁽¹⁾ : 2088. Verdi basert på 4. GIEC-rapport.

Mengden kuldemedium basert på regelverket F Gaz 517/2014 er angitt på dataplatten på enheten.

Ethvert arbeid på kjølesystemet skal gjøres av en godkjent fagperson som nevnt over.

Periodiske inspeksjoner av lekkasje av kuldemedium kan være nødvendig avhengig av europeisk eller lokalt regelverk. Vennligst kontakt din lokale forhandler for mer informasjon.

- Vær oppmerksom på at kjølemediet kan være luktfritt.
- Rørene må ikke stilles hull på eller varmes opp, da det er risiko for eksplosjon og alvorlige brannskader.
- Bruk ikke metoder for akselerering av avisings- eller rengjøringsprosessen som ikke anbefales av fabrikanten.
- Apparatet skal lagres i et lokale der det ikke befinner seg permanent fungerende kilder til antennelse (for eksempel nakne flammer, fungerende gassapparat eller elektrisk radiator).

(1) Globalt oppvarmingspotensial

2. SPESIFIKASJONER

2.1 Varmepumpens ytelse



Modell	ENERGYLINE PRO	ENP10TAS
Varmekapasitet*	kW	36,9
Strømforbruk *	kW	6,87
Strøm*	A	14,8
Strømforsyning	V / Ph / Hz	400 V / 3N~ / 50Hz
Sikringsstørrelse av typen aM	A	20
Effektbryter Kurve D	A	20
Antall kompressorer	/	1
Kompressortype	/	Scroll
Antall vifter	/	2
Vifte	W	50 - 225
Viftens rotasjonshastighet	RPM	600 - 1050
Vifteretning	/	Horizontal
Lydtrykknivå (ved 10 m) LpA	dB(A)	41
Vanntilkobling	mm	63
Nominell sirkulasjonsmengde*	m ³ /h	13
Fall i vanntrykk (maks.)	kPa	13,8
Dimensjoner, netto (L/V/H)	mm	1482 / 485 / 1480
Enhetens nettovekt	kg	182

* Ytelse i henhold til Prøvestandard NF EN 14511, gjentatt i sertifiseringsdokumentet NF-414.
Tørr luft 15°C - Relativ fuktighet 71% - Temperatur av inngående vann 26°C.

2. SPESIFIKASJONER (fortsetter)

2.2 Driftsområde

Bruk varmepumpen i de følgende temperatur- og fuktighetsområder for å sikre en trygg og effektiv drift.

	Oppvarmingsmodus 	Kjølemodus 
Utetemperatur	-12°C ~ +35°C	+7°C ~ +43°C
Vanntemperatur	+12°C ~ +40°C	+8°C ~ +40°C
Relativ luftfuktighet	< 80%	< 80%
Innstillingsområde for settpunkt	+15°C ~ +32°C	+8°C ~ +32°C



Hvis temperatur eller luftfuktighet ikke samsvarer med disse betingelsene, kan sikkerhetsanordninger aktiveres og varmepumpen slutte å fungere.



Maksimumstemperaturen for oppvarming er begrenset til 32°C for å unngå forringelse av foringene. Hayward fraskriver seg alt ansvar i tilfelle av en bruk utover 32°C.

2. SPESIFIKASJONER (fortsetter)

2.3 Dimensjoner

Model: ENP10TAS

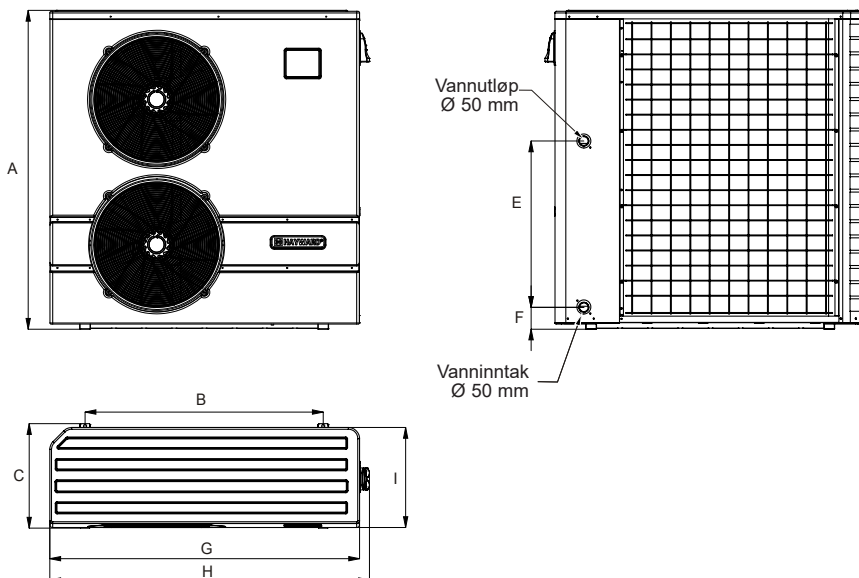

Enhet: mm

Model	ENP10TAS
Nummer	
A	1480
B	1105
C	485
D	/
E	771,5
F	101,5
G	1437
H	1483
I	464

3. INSTALLERING OG TILKOBLING

3.1 Skjematisk diagram

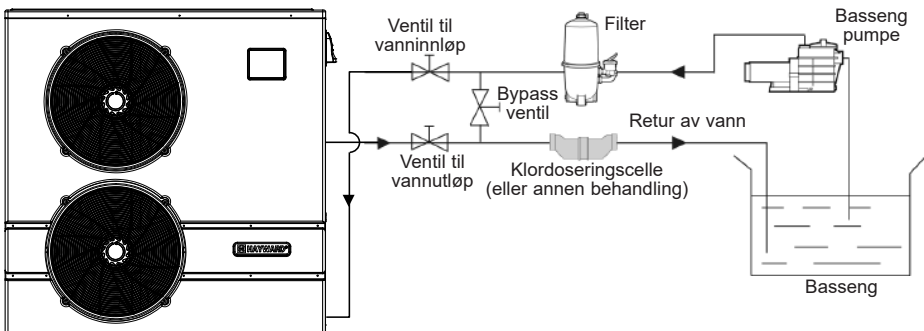

Merk: Varmepumpen er levert uten noe utstyr for behandling eller filtrering. Elementene som presenteres i diagrammer er deler som må leveres av installatøren.

3.2 Varmepumpe



Plasser varmpumpen utendørs, og ikke i lukkede tekniske lokaler. Velg helst et sted i solen og i ly for dominerende vind.

Apparatet skal være lett tilgjengelig for installering eller vedlikehold som skal gjøres på et senere tidspunkt.

Plassert under beskyttelse, må minsteavstander angitt nedenfor følges for å unngå resirkulering av luft, og en degradering av varmpumpens i totale prestasjoner.

Enhet: mm

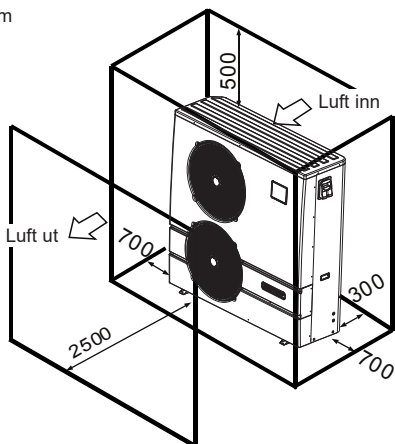

3. INSTALLASJON OG TILKOPLING (fortsettelse)



Apparatet må ikke plasseres rett på bakken da den kan forårsake forstyrrelser. Ved plassering på bakken skal man privilegerer bruk av vibrasjonsabsorbatorer. Man skal ikke bruke veggfeste under omstendigheter som kan viderebringe vibrasjoner. Varmepumpen må ikke installeres på et underlag som risikerer å forsterke enhetens vibrasjoner.

Varmepumpen må ikke installeres på et sted hvor støynivået vil kunne forsterkes, eller på et sted hvor støyen fra enheten vil kunne være til sjenanse for naboene.

Bruk ikke teip, da det ikke er å anse som pålitelige festesystemer.

Varmepumpen skal aller helst installeres på en betongplate som er flat og desolidarisert.

Monter varmpumpen på de medfølgende Silentbloc-underlagene (skruer og skiver inkludert).

Fest apparatet ved å overholde reglene for tilstramming som angis, dette for å unngå all risiko for ulykke eller skade på materiell og personer. En annen mulighet er å installere varmpumpen på et gummi-underlag ved hjelp av tilpassede skruer (følger ikke med).

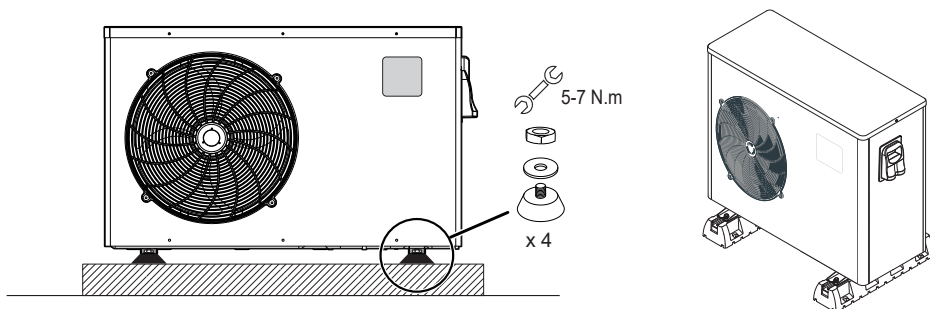

Maksimal avstand for installasjon mellom varmpumpen og bassenget 15 meter.

Total tur-retur lengde for vannkanalene 30 meter.

Isoler vannkanaler på bakken og under jorden.

Varmepumpen må bygges opp og installeres med en minimum avstand fra bassenget, i henhold til standard NF C 15-100 (minst 3,5 meter fra bassenget i Frankrike) eller i henhold til gjeldende regler og forskrifter i hvert enkelt land.

Varmepumpen må ikke installeres i nærheten av en varmekilde.

I land hvor det er mye snø, bør det bygges opp et tak over maskinen for å unngå at snø bygger seg over ribbene på varmpumpen.

3. INSTALLERING OG TILKOBLING (fortsetter)

3.3 Vanntilkobling

Varmepumpen leveres med to koblingsdeler med diameter på 50 mm. Bruk PVC-rør på Ø 50 mm for vannkanaler. Koble varmpumpens vanninnløp til kanalen fra filteringsenheten, og koble deretter varmpumpens vannutløp til kanalen som går til bassenget (se diagram nedenfor).

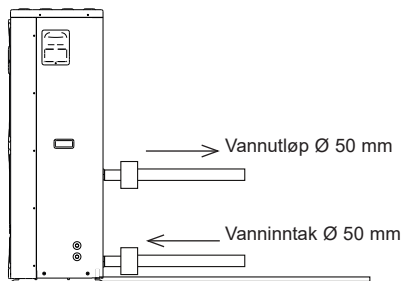

Installer en bypassventil mellom varmpumpens vanninnløp og vannutløp.



Dersom automatisk fordeler eller klordoseringscelle benyttes, må det være installert etter varmpumpen, for å beskytte Titanium-kondensatoren mot en for stor konsentrasjon av kjemiske stoffer.



Sørg for å installere bypassventilen og de medfølgende koblingsdelene ved enhetens vanninnløp og vannutløp, for å forenkle tømning om vinteren, for å forenkle tilgang eller demontering for vedlikehold.

3. INSTALLERING OG TILKOBLING (fortsetter)

3.4 Elektrisk tilkobling



Den elektriske installasjonen og kabling av dette utstyret må være i overensstemmelse med lokale forskrifter for installasjoner.

F	NF C15-100	GB	BS7671:1992
D	DIN VDE 0100-702	EW	EVHS-HD 384-7-702
A	ÖVE 8001-4-702	H	MSZ 2364-702/1994/MSZ 10-553 1/1990
E	UNE 20460-7-702 1993, RECBT ITC-BT-31 2002	M	MSA HD 384-7-702.S2
IRL	Wiring Rules + IS HD 384-7-702	PL	PN-IEC 60364-7-702:1999
I	CEI 64-8/7	CZ	CSN 33 2000 7-702
LUX	384-7.702 S2	SK	STN 33 2000-7-702
NL	NEN 1010-7-702	SLO	SIST HD 384-7-702.S2
P	RSIUEE	TR	TS IEC 60364-7-702



Kontroller at den tilgjengelige strømforsyningen og nettfrekvensen stemmer overens med operasjonelle krav, og tar hensyn til den spesifikke plasseringen til apparatet, og nødvendig strøm til å drive alle andre apparater som er koblet til samme krets.

ENP10TAS 400 V \sim +/- 10 % 50 Hz 3 faser

 Sjekk at fase likevekten ikke overskrider 2%

Følg tilsvarende koblingsskjema i vedlegg.

Koblingsboksen ligger på enhetens høyre side. Tre tilkoblinger er til strømforsyning, og to til å styre filtreringspumpen (servomekanisme).

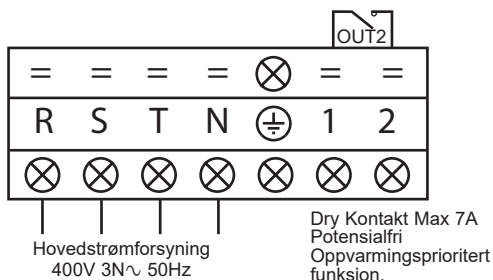

3. INSTALLERING OG TILKOBLING (fortsetter)



Man må under ingen omstendigheter bruke et elektrisk støpsel til strømtilførselen.

Den elektriske strømtilførselslinjen skal være riktig utstyrt med en all-pol beskyttelse av typen bryter med D-kurve og med en beskyttende differensialbryter på 30 mA (se tabell nedenfor).

Model		ENP10TAS
Elektrisk strømforsyning	V/Ph/Hz	400V 3N~ 50Hz
Sikringsstørrelse av typen aM	A	20 aM
Effektbryter Kurve D	A	20 D
Kabelseksjon	mm ²	5G4 5 x 4



Bruk en kabel av typen RO RO2V/R2V eller tilsvarende.



Kabelseksjonene er gitt for en lengde på maksimalt 25 meter. De må allikevel kontrolleres og tilpasses de gjeldende installasjonsforholdene.



Pass alltid på å stanse hovedstrømforsyningen før du åpner den elektriske kontrollboksen.

3.5 Førstegangs oppstart

Oppstartsprosedyre - når installasjonen er fullført bør du gjøre følgende:

- 1) Roter viften for hånd for å sikre at den kan rotere fritt for hånd, og at spiralen er riktig festet til motorakselen.
- 2) Se til at enheten er riktig tilkoblet til hovedstrømforsyningen (se koblingsskjema i vedlegg).
- 3) Slå på filtreringspumpen.
- 4) Se til at alle vannventiler er åpne og at vannet renner inn i enheten før varme eller avkjøling skrur på.
- 5) Sjekk at kondensutløpet er festet riktig og er fri for blokkeringer.
- 6) Aktiver enhetens strømforsyning og trykk på On/Off-knappen  på kontrollpanelet.

3. INSTALLERING OG TILKOBLING (fortsetter)

- 7) Se til at ingen alarmkode vises når enheten er på (se veiledning for feilsøking).
- 8) Fastsett vannstrømmen ved hjelp av bypassventilen (se kapittel 3.6 og 2.1), som angitt for hver modell, slik at du oppnår en temperaturforskjell på 2 °C mellom vanninnløp og vannutløp.
- 9) Etter den har stått på noen minutter, sjekk at luften som kommer ut av enheten er kjøligere (mellom 5-10 °C).
- 10) Slå av filtreringspumpen mens enheten er i drift. Enheten skrur også av automatisk og viser feilkoden E03.
- 11) La enheten og filtreringspumpen stå på hele døgnet helt til ønsket vanntemperatur er nådd. Enheten slås av når gitt temperatur for vanninnløp av nådd. Enheten vil nå automatisk restarte (så lenge filtreringspumpen er på) når vanntemperaturen blir 2 °C mindre enn angitt temperatur.

Vannsirkulasjonsbryter - Enheten er utstyrt med en bryter som aktiverer varmepumpen når filtreringspumpen er på, og skrur den av når pumpen skrur av. Ved mangel på vann, vises alarmkoden E03 på kontrolleren (Se kapittel 6.4).

Tidsforsinkelse - enheten er utstyrt med en innebygd 3-minutters omstartsforsinkelse for å beskytte kontrollkretsens deler og for å fjerne omstartssyklus og støy. Denne tidsforsinkelsen vil automatisk omstarte enheten ca. 3 minutter etter hver avbrytelse av kontrollkretsen. Selv et kort strømavbrudd vil aktivere tidsforsinkelsen og forhindre enheten fra å starte før nedtellingen på 3 minutter er over.

Fasekontroller - Enheter med trefaset forsyning inneholder en fasekontroller som sørger for at kompressoren går rundt riktig vei. Dersom enheten ikke starter, må du sjekke om fasekontrolleren i strømboksen er i stand.

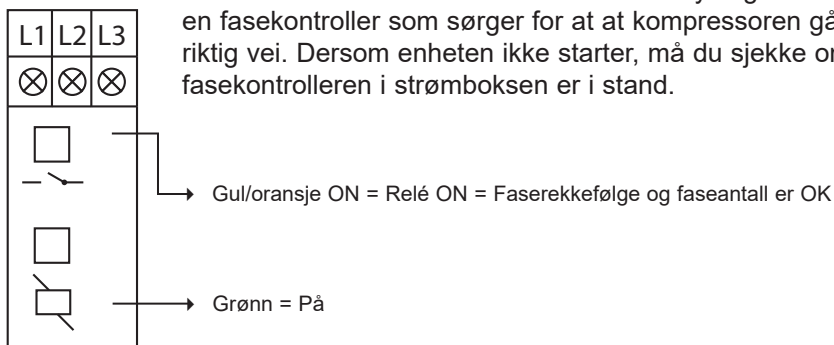

3. INSTALLERING OG TILKOBLING (fortsetter)

3.6 Innstilling av vannstrømmen

Ventilene for vanninnløp og vannutløp er åpne, juster bypassventilen for å få en temperaturforskjell på 2 °C mellom vanninnløp og vannutløp (se skjematisk diagram kapittel 3.1). Du kan kontrollere innstillingen ved å se på temperaturene for innløp/utløp direkte på kontrollpanelet.

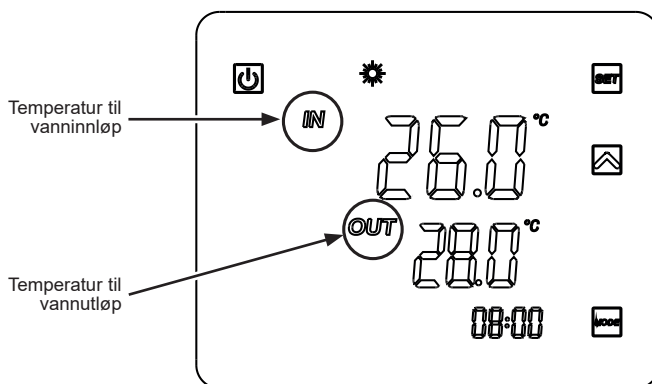

Merk: Åpningen av bypassventilen genererer en mindre viktig strømning eller økt ΔT .

Lukking av bypassventilen genererer en sterkere strømning, eller en nedgang i ΔT .

4. BRUKERGRENSESNITT

4.1 Oversikt

Varmepumpen er utstyrt med et digitalt kontrollpanel med berøringsskjem, elektrisk tilkoblet og forhåndsinnstilt i fabrikk til varmedrift.

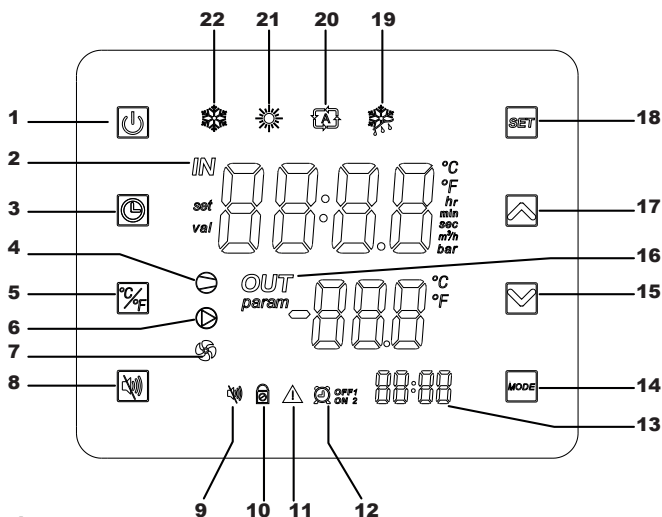

Tegnforklaring

1		On/Off
2		Vanninnløp
3		Innstilling av tid og Timer
4		Kompressor ON
5		Konvertering °C/°F
6		Tørr kontakt OUT2
7		Fan ON
8		Silence-modus
9		Indikator for Silence-modus
10		Låst skjerm
11		Alarm

12		Timers 1 og 2
13		Timers Klokkeslett
14		Valg av modus
15		Nedover / Minske
16		Vannutløp
17		Oppover / Øke
18		Lagre / Innstillinger
19		Tine modus
20		Automatisk modus
21		Oppvarmings modus
22		Kjøle modus

4. BRUKERGRENSESNITT (fortsetter)

OFF-modus

Når varmpumpen er i standby (OFF-modus) vil teksten "OFF" vises på kontrollskjermen.

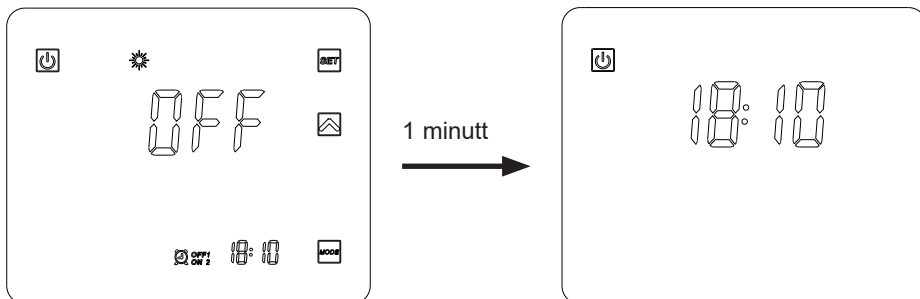

ON-modus

Når varmpumpen er i drift eller under innstilling (ON-modus) vil temperaturer for vanninnløp og vannutløp vises på kontrollskjermen.

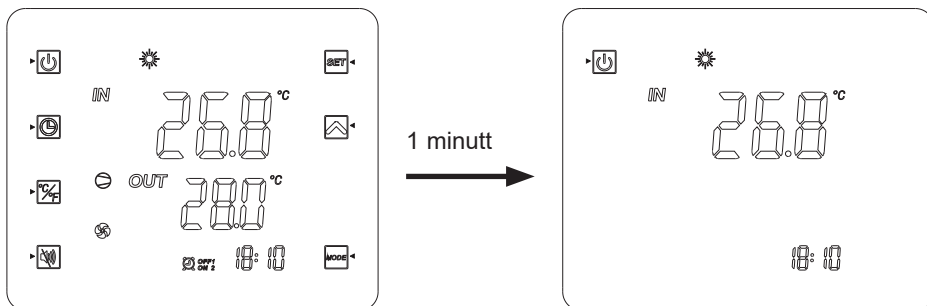









4. BRUKERGRENSESNITT (fortsetter)

På slutten av innstillingene, trykker du på  bekrefte.
Opptakstillinger automatisk etter 20-årene uten handling.

4.2 Innstilling av tid

Hvis displayet står i standby-modus, trykk lett på knappen .









- 1) Trykk på  for få frem symbolet .
- 2) Trykk på , klokkeslettet begynner å blinke. Still timetallet ved hjelp av knappene  .
- 3) Trykk på  og still minuttene ved hjelp av knappene  .
- 4) Bekreft ved å trykke på .

4.3 Innstilling av Timer











Du stiller inn på denne funksjonen hvis du ønsker å sette varmepumpen i drift i løpet av en kortere periode enn den som er fastsatt av filtreringstimeren. Slik kan du programmere en forsinket start og en tidligere stans, eller rett og slett forby en tidsinnstilling for drift (for eksempel om natten).



Du kan programmere 2 Start-timere (ON1 og ON2) og 2 Stopp-timere (OFF1 og OFF2).

Programmere Timer 1 – Start

- 1) Trykk på  i 2 sekunder, Timeren ON1  blinker (*).
- 2) Trykk på  for å stille timene ved hjelp av knappene  .
- 3) Trykk på  for å stille minuttene ved hjelp av knappene  .
- 4) Bekreft ved å trykke på .

Programmere Timer 1 – Stopp



- 1) Trykk på  i 2 sekunder, Timeren ON1  blinker (*).
Trykk 1 gang på , timeren OFF1  blinker.
- 2) Trykk på  for å stille timene ved hjelp av knappene  .
- 3) Trykk på  for å stille minuttene ved hjelp av knappene  .
- 4) Bekreft ved å trykke på .



(*) For å komme direkte på Timer ON2 , trykk  i 2 sekunder, og trykk 2 ganger på .

4. BRUKERGRENSESNITT (fortsetter)













Programmering av Timer 2



Etter å ha justert Timer 1, kommer du direkte til innstillingene av Timer 2:

 og . Gå fram på samme måte som for Timer 1.

Nota: For å komme direkte på Timer ON2 , trykk  i 2 sekunder, og trykk 2 ganger på .

Sletting av Timere (Start og Stopp)

- 1) Trykk på  i 2 sekunder, Timeren ON1  blinker (*).
- 2) Trykk på , klokkeslettet begynner å blinke.
- 3) Trykk på  for å slette Timeren .
- 4) Trykk på  for å bekrefte.
- 5) Trykk på  i 2 sekunder, Timeren ON1  blinker.
Trykk 1 gang på , ITimeren  blinker.(*)
- 6) Trykk på , klokkeslettet begynner å blinke.
- 7) Trykk på  for å slette Timeren .

(*) For å komme til Timer 2 eller  og , følg punkt 1) eller 4) og trykk 2 ganger på . Gå fram på samme måte som ovenfor.

4.4 Valg av driftsmodus

i modus “OFF” eller “ON”

Trykk på  knappen for å bytte modus: kjøling, oppvarming eller auto.

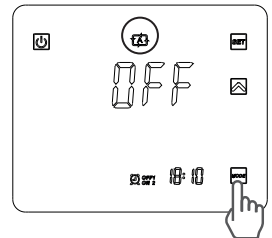
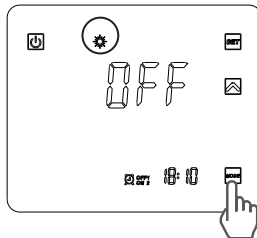
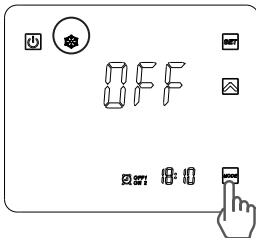



Hvis varmepumpen er satt i oppvarming bare eller kjølemodus, er ikke mulig skifte av modus.

4. BRUKERGRENSESNITT (fortsetter)



4.5 Innstilling og visning av settpunkt

(ønsket vanntemperatur)

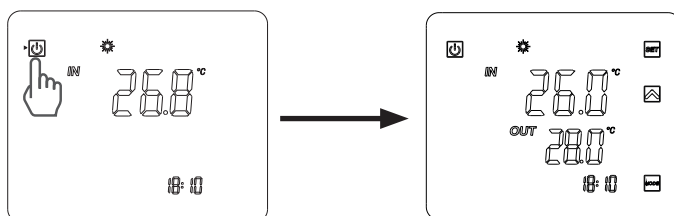
Hvis  knappen ikke er synlig på displayet, trykk lett på .
(Enten utstyret er på eller av, er det nok å trykke på knappen  for å se settpunktet.)



I modus "OFF" og Modus "ON"





Trykk på knappen  for å vise settpunktet, og trykk deretter på  eller  for å registrere et ønsket settpunkt.

Innstillingen foretas med en nøyaktighet på 0,5 °C.



Det anbefales å ikke overstige en temperatur på 30 °C for å unngå forandring i basseng-liners.

4.6 Låse og låse opp berøringskjermen

Trykk på tasten  i 5 sek. til det høres et pipesignal, og symbolet  vises.
For å låse opp, trykk  i 5 sek. til det høres et pipesignal, og symbolet  vises.

4. BRUKERGRENSESNITT (fortsetter)

4.7 Stillemodusinnstilling

Denne funksjonen gjør at varmpumpen kan brukes med redusert vifteshastighet på 600 omdreininger/min i maksimalt 8 timer, noe som gjør at man kan redusere sjenerende støy om natten eller om dagen i forhold til hvor den er plassert med hensyn til naboer eller til bassenget.



Denne funksjonen kan aktiveres/deaktiveres enten manuelt eller ved hjelp av en tidtaker.

Manuell aktivering

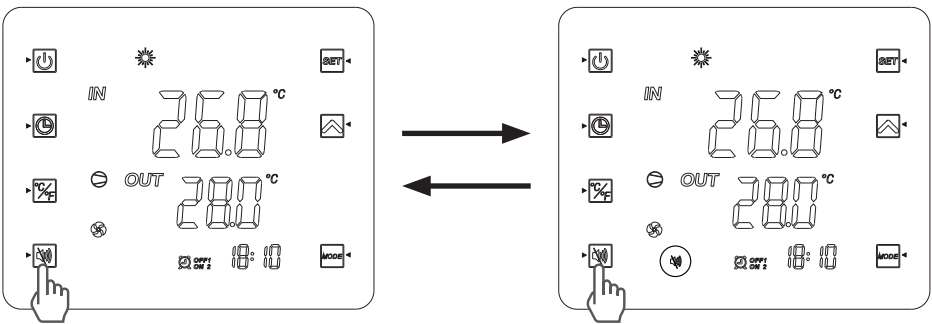
- 1) Trykk på knappen .
- 2) Bildet nedenfor vises på skjermen, Silence-modusen er aktivert for de følgende 8 timene.
- 3) Viftene reduseres gradvis hastigheten en periode på 8 timer.
- 4) Etter 8 timers drift blir funksjonen automatisk slått av og vifteshastigheten vil gjenoppta funksjon av utetemperaturen.



Manuell deaktivering

- 1) Trykk på knappen .
- 2) Skjermen indikerer  som vist nedenfor, stille-modus er deaktivert.
- 3) Viftene tilplasser vifteshastigheten etter utetemperaturen.

4. BRUKERGRENSESNITT (fortsetter)





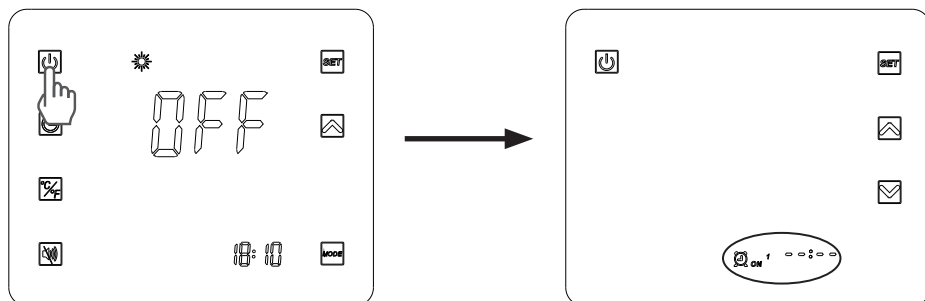

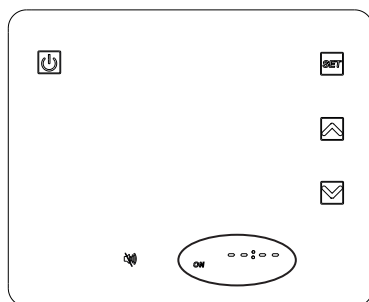

Programmering av STILLE-modus

- 1) Trykk på  i 2 sekunder, Timeren ON1  ON ¹ blinker.









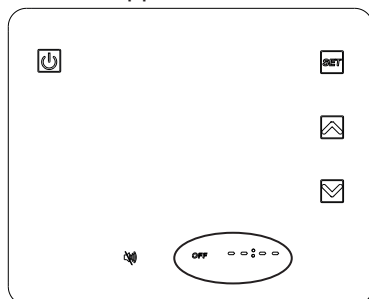

- 2) Trykk 4 ganger på  til du kommer til displayet avbildet nedenfor.



- 3) Trykk på , klokkeslettet begynner å blinke. Bruk pilene   for å stille inn timetallet for oppstart.
- 4) Trykk på , minuttene blinker. Bruk pilene   for å stille inn minuttene for oppstart. Bekreft ved å trykke på .
- 5) Trykk på  for å stille inn stopptiden: ordet OFF blinker.



4. BRUKERGRENSESNITT (fortsetter)

- 6) Trykk på , klokkeslettet begynner å blinke. Bruk pilene   for å stille inn timetallet for stopptiden.
- 7) Trykk på , minuttene blinker. Bruk pilene   for å stille inn minuttene for stopptiden. Bekreft ved å trykke på .
- 8) Trykk på  for å komme tilbake til forrige skjerm.
ON-OFF vises slik som herunder avbildet.

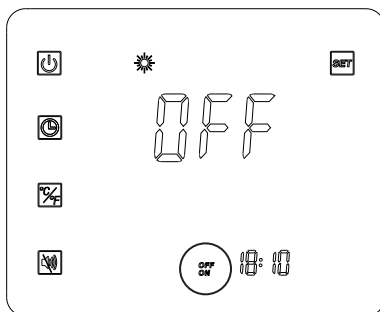

Nota : Ikke stilt inn minuttene og fra 10 til 10.

Når modusinnstillingen SILENCE er fullført, er den aktivert som standard 7d/7d.

5. VEDLIKEHOLD OG VINTERKLARGJØRING

5.1 Vedlikehold

Disse vedlikeholdsoperasjonene må utføres 1 gang i året for å sikre lang levetid og god drift av varmepumpen.

- Rengjør fordampere med en myk børste eller med en luft- eller vannstråle (**NB! Bruk aldri høytrykksspyler**).
- Kontroller evakueringen av kondensater.
- Kontroller at elektriske og hydrauliske koplinger sitter godt.
- Kontroller vanntettheten til kondensatoren.



Før alt vedlikehold må varmepumpen være frakoplet alle strømkilder. Vedlikeholdsoperasjonene skal kun utføres av kvalifisert personell med kompetanse til å håndtere kuldemedier.

5.2 Vinterklargjøring

- Sett varmepumpen i "OFF"-modus.
- Slå av strømtilførselen til varmepumpen.
- Tøm kondensatoren ved hjelp av tømmeventilen for å unngå fare for forringelse. (Stor risiko for frost).
- Steng "by-pass"-ventilen og skru løs koplingsdelene for vanninnløp/-utløp.
- Fjern maksimalt med stillestående vann som er igjen i kondensatoren ved hjelp av en blåsepistol.
- Tett igjen varmepumpens vanninnløp og -utløp for å forhindre fremmedlegemer i å trenge seg inn.
- Dekk til varmepumpen med et vintertrekk (leveres ikke med).



Alle skader som er forårsaket av dårlig vinterklargjøring, vil oppheve garantien.

6. VEDLEGG

6.1 Koblingskjemaer

ENP10TAS

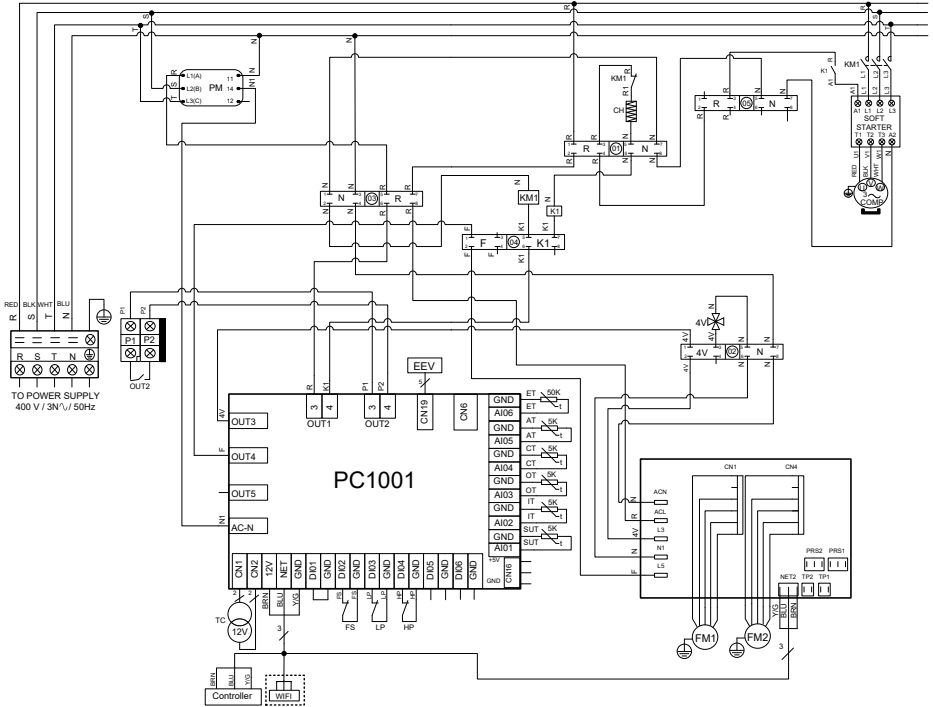

MERKNADER:

- AT : SENSOR FOR LUFTEMPERATUR
- COMP : KOMPRESSOR
- CT : SENSOR FOR FORDAMPET TEMPERATUR
- EEV : ELEKTRONISK EKSPANSJONSVENTIL
- FM1-2 : VIFTEMOTOR
- FS : VANNSENSOR
- HP : HØYTRYKKSBRYSER
- IT : TEMPERATURSENSOR TIL VANNINNØP
- LP : LAVTRYKKSBRYSER

- OT : TEMPERATURSENSOR TIL VANNUTLØP
- SUT : SENSOR FOR SUGETEMPERATUR
- TC : OMFORMER 230V ~ / 12V ~
- 4V : 4-VEIS VENTIL
- KM1 : KONTAKTOR FOR KOMPRESSOR
- PM : FASEKONTROLLER
- CH1 : BUNNKASSEVARMER
- ET : TEMPERATURSENSOR FOR UTLADNING
- OUT2 : POTENSIALFRI KONTAKT, MAKS. 7A
- [] : OPSJON

6. VEDLEGG (fortsetter)

6.2 Kobling med prioritet på trefaset varmpumpe

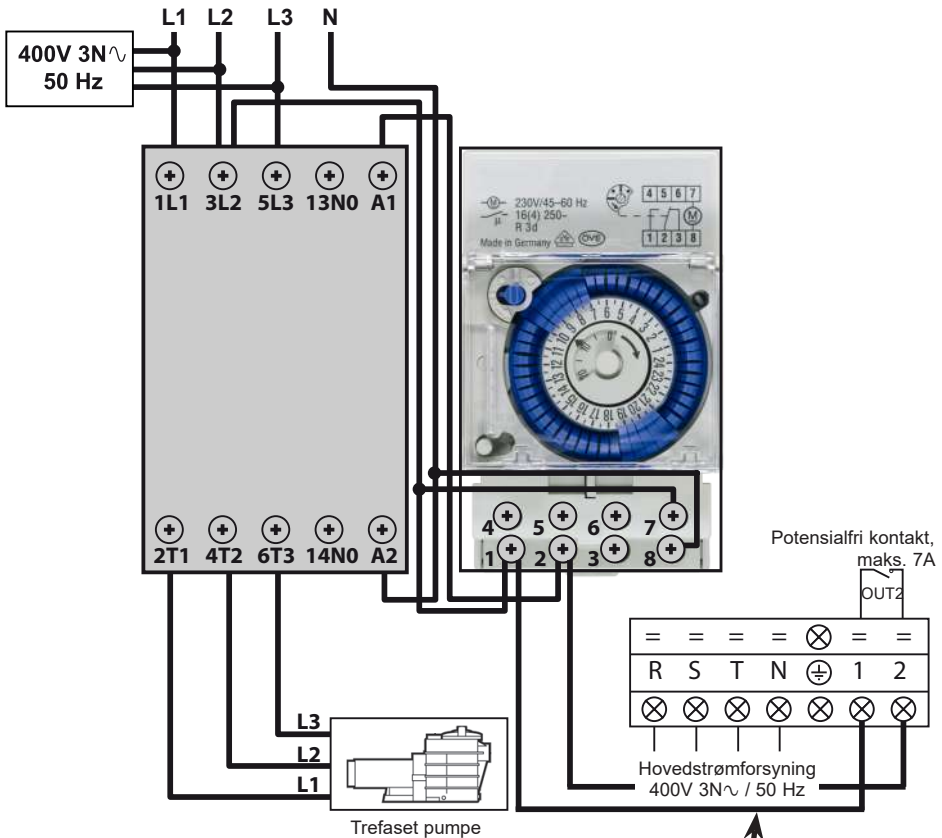

“Terminalene 1 og 2 gir et tørt kontaktpotensial uten polaritet 230 V~ / 50 Hz.

Kabling til klemmene 1 og 2 i samsvar med ledningene beskrevet ovenfor, for å kontrollere driften av pumpen ved filtrering syklus 2 min hver time hvis temperaturen i tanken er under det innstilte punktet. “

 Aldri koble strømtilførselen til filterpumpen direkte på terminalene 1 og 2.



Denne siden er blank med hensikt

6. VEDLEGG (fortsetter)

6.3 Sprengskisse og reservedeler

ENP10TAS

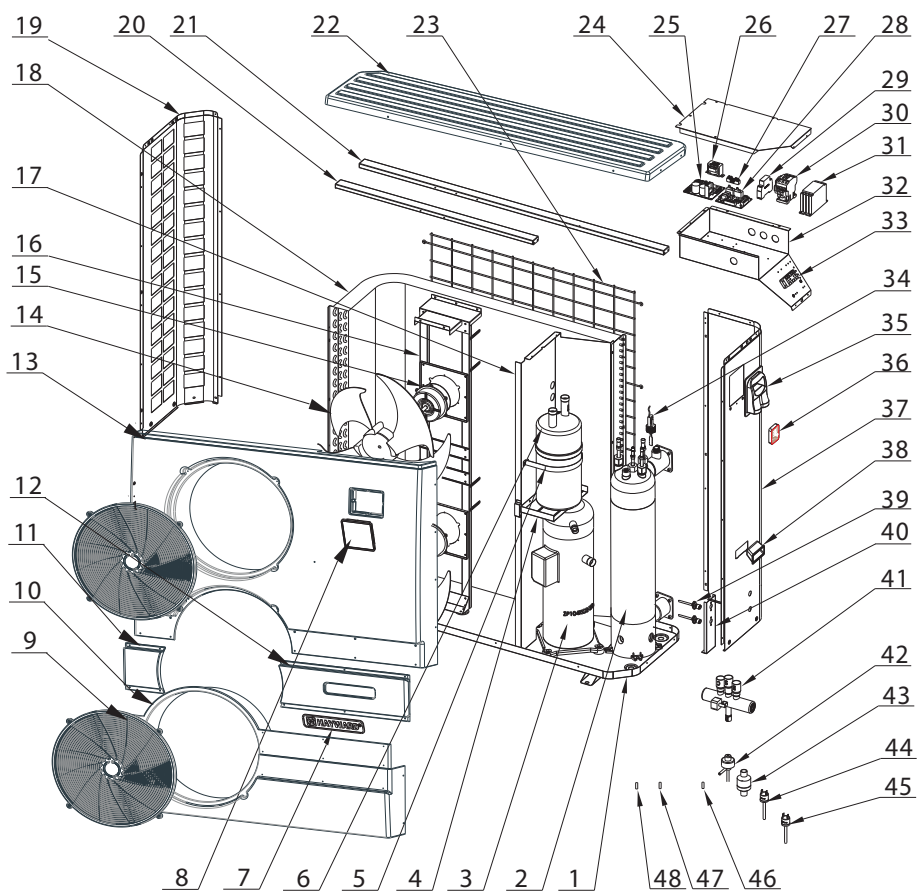

6. VEDLEGG (fortsetter)

ENP10TAS

Nr.	Ref.	Betegnelse	Nr.	Ref.	Betegnelse
1	HWX32005210049	Bunn	27	HWX20003909	Terminal 2 tilkøplinger
2	HWX32005120009	Kondensator Titanium/ PVC	28	HWX950531014516	Elektronisk kort
3	HWX20000110153	Kompressor	29	HWX200036023	Fase controller
4	HWX32027210011	Holder for væsketank	30	HWX20000360209	Kompressorkontaktor trefase
5	HWX32027210013	Slangeklemmer	31	HWX20000360092	Elektronisk starter TRI
6	HWX35141402	Reservoarfluidet	32	HWX32005210054	Strømboks
7	HWX20000230596	Hayward-logo	33	HWX20000390180	Terminal 5 tilkoblinger Tri
8	HWX95005010018	LED Controller	34	HWX200036005	Sensor for vannstrømning
9	HWX32020220001	Beskyttelsesgitter for viften	35	HWX32009220032	Trappe elektrisk tilgang
10	HWX32005220002	Nedre frontpanel	36	HWX95005010014	Wireless Modul
11	HWX32005220005	Venstre dekorpanel	37	HWX32005210060	Høyre panel
12	HWX32005220004	Høyre dekorpanel	38	HWX32008220037	Håndtak
13	HWX32005220001	Øvre frontpanel	39	HWX20000140353	Trykkran H&L
14	HWX20000270025	Viftproprell	40	HWX32019210038	Støtteplate med koblong til høytrykk/lavtrykk
15	HWX20000330361	Likestrømsmotor	41	HWX20011488	4-veisventil
16	HWX32005210058	Motorstøtte	42	HWX20000140338	Elektronisk ekspansjonsventil
17	HWX32005210065	Skillepanel	43	HWX20041455	Filter
18	HWX32005120008	Fordamper	44	HWX20003603	Strømningsbegrenser
19	HWX32005210051	Venstre panel	45	HWX20013605	Høytrykkspressostat
20	HWX32005220055	Kort forsterkningselement	46/47	HWX20003242	Fordamper/luft/vann- temperatursensor
21	HWX32005210056	Wide forsterkningselement	48	HWX20003223	Kompressorsensor 50 kΩ
22	HWX32005220003	Øvre panel	*49*	HWX20000240208	Vinterkledning
23	HWX32005210063	Fordamperbeskyttelse	*50*	HWX200026009	O-ring ID 48-tykkelse 5 mm
24	HWX32005210053	Elektrisk beskyttelse panel	*51*	HWX200026061	O-ring ID 43-tykkelse 3,4 mm
25	HWX950531024107	Likestrømsinvertermodul	*52*	HWX20003214	Strømningsbegrenser
26	HWX200037003	Transformator 230V _~ - 12V _~	*53*	HWX20002625	Anti-vibrasjonsmontering

Merknad: * xx * merkene er ikke referert til i tilsvarende deletegninger.

6. VEDLEGG (fortsetter)

6.4 Veiledning for feilsøking



Enkelte operasjoner må utføres av en kvalifisert tekniker.

I tilfelle feil, vil følgende meldinger vises på skjermen:

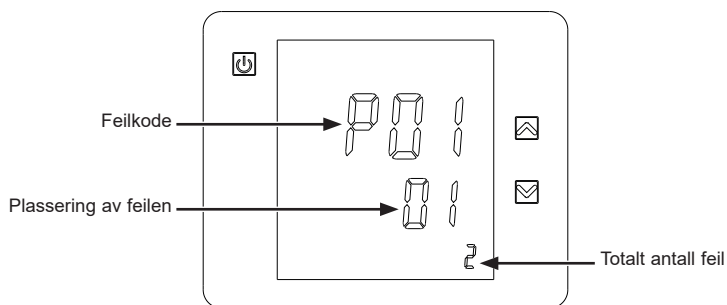

Hvis det oppstår flere feil, trykk på  eller  for å bla fra den ene feilkoden til den neste. Se tabellen lenger ned.

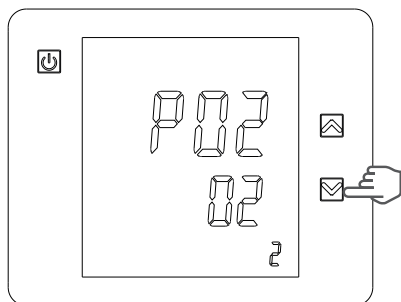

6. VEDLEGG (fortsetter)

Feil	Feilkoder	Beskrivelse	Løsning
Feil i temperatursensor til vanninnløp	P01	Sensoren er åpen eller det er en kortslutning.	Sjekk eller skift ut sensoren.
Feil i temperatursensor til vannutløp	P02	Sensoren er åpen eller det er en kortslutning.	Sjekk eller skift ut sensoren.
Feil på avrimingssensor	P05	Sensoren er åpen eller det er en kortslutning.	Sjekk eller skift ut sensoren.
Feil på sensor til utendørstemperatur	P04	Sensoren er åpen eller det er en kortslutning.	Sjekk eller skift ut sensoren.
Standard kompressoraspirasjon	P07	Sensoren er åpen eller det er en kortslutning.	Sjekk eller skift ut sensoren.
Temperaturforskjellen mellom vanninnløp og vannutløp er for stor	E06	Det er ikke nok vannsirkulasjon, forskjellen i vannsirkulasjon er for lav/for stor.	Sjekk vannsirkulasjonen, eller blokkeringer i systemet.
Tinesyklus Kjølemodus	E07	Vannutløpet er for lavt.	Sjekk vannsirkulasjonen eller vannutløpets temperatursensor.
Første nivå av frostbeskyttelse om vinteren	E19	Rom- eller innløpstemperatur er for lav.	
Andre nivå av frostbeskyttelse om vinteren	E29	Rom- eller innløpstemperatur er enda lavere.	
Høytrykksbeskyttelse	E01	Trykket i kjølekretsen er for høy, vannsirkulasjonsgraden er for lav, fordampere er tett, luftsirkulasjon er for lav.	Sjekk høytrykksbryteren og trykket i kjølekretsen. Sjekk vann- og luftsirkulasjonen. Kontroller at vannsirkulasjonsbryteren fungerer som den skal. Kontroller ventilåpninger for vanninnløp/vannutløp. Kontroller innstilling av bypass.
Lavtrykksbeskyttelse	E02	Trykket i kjølekretsen er for lavt, vannsirkulasjonsgraden er for lav eller fordampere er tett.	Sjekk lavtrykksbryteren og trykket i kjølekretsen for å vurdere om der er en lekkasje. Rengjør overflaten på fordampere. Sjekk hastigheten til vifterotasjonen. Sjekk den frie flyten av luft gjennom fordampere.
Feil i sensor for vannstrømning	E03	For lite vann, eller kortsluttet eller defekt sensor	Sjekk vannstrømmen, sjekk filteringspumpen og strømningssensoren for å se etter eventuelle defekter.
Kommunikasjonsfeil	E08	Feil i LED-kontroller eller PCB-forbindelsen.	Kontroller kabelløsløpingene NET og NET 1.
Kompressoren starter ikke	E08	Enten mangler det en fase, eller er faserekkefølgen feil	sjekk at alle 3 faser er på plass endre faserekkefølgen i koblingsboksen på varmpumpa.

6. VEDLEGG (fortsetter)

6.5 Garanti

GARANTIBETINGELSER

HAYWARD garanterer at deres produkter er fri for defekter i materiale og i utførelse for en periode på to år fra innkjøpsdato. Ved evt. garantikrav, må kvittering for kjøpet fremlegges. Vi ber om at kvitteringen blir tatt vare på av kjøper.

HAYWARD garanti er, etter HAYWARD eget valg, begrenset til erstatning eller reparasjon av defekte produkter som har vært i normal bruk og behandlet i henhold til instruksjonsboken, uten at det har vært foretatt endringer av produktet, og at bare ekte HAYWARD deler har vært brukt. Skader som skyldes frost og kjemiske reaksjoner er ikke omfattet av denne garanti.

HAYWARD er ikke ansvarlig for noen andre kostnader (flytting, arbeidskostnader osv...), heller ikke for direkte eller indirekte skader som skyldes funksjonsfeil ved et produkt.

For å sette i gang et garantikrav og å be om reparasjon eller erstatning av et produkt, vennligst ta kontakt med forhandleren. Forsendelse av produkter direkte til vår fabrikk blir ikke akseptert uten vår skriftlige forhåndsgodkjenning.

Slitasjedeler omfattes ikke av garantien.

6.6 Apparatet ved endt levetid



Symbolet som viser en søppelbøtte med strek over er knyttet til gjenvinning av elektrisk og elektronisk avfall, som betyr at produktene under ingen omstendigheter kan kastes sammen med vanlig søppel, på søppelfylling eller med spesialavfall.

 Ved endt levetid skal apparatet kildesorteres for resirkulering eller gjenvinning. Det finnes et spesielt system for innsamling av denne typen produkter i EU og i Norge.

Kontakt installatøren eller dennes lokale representant for innsamling, demontering og resirkulering av apparatet.

Behandlingen av kjølevæsken, olje og andre deler skal gjøres av kvalifisert, godkjent fagperson i overensstemmelse med de lokale og nasjonale regler.

Dersom produktet inneholder batterier med dette symbolet, betyr det at batteriene kan inneholde farlige og forurensende substanser. Batteriene må da leveres inn til et spesielt innsamlingssted.

ENERGYLINE PRO

ТЕПЛОВОЙ НАСОС ДЛЯ ПЛАВАТЕЛЬНОГО БАССЕЙНА



ENP10TAS

Руководство по монтажу и эксплуатации

СОДЕРЖАНИЕ

1. ОБЩИЕ ИНСТРУКЦИИ - БЕЗОПАСНОСТЬ	1
2. ТЕХНИЧЕСКИЕ ХАРАКТЕРИСТИКИ	4
2.1 Технические данные теплового насоса	4
2.2 Рабочий диапазон	5
2.3 Размеры	6
3. УСТАНОВКА И ПОДКЛЮЧЕНИЕ	7
3.1 Принципиальная Схема	7
3.2 Тепловой насос	7
3.3 Гидротехническое подключение	9
3.4 Электрическое Подключение	10
3.5 Первый запуск	11
3.6 Установка пропускной способности насоса	13
4. ИНТЕРФЕЙС ПОЛЬЗОВАТЕЛЯ	14
4.1 Общие сведения	14
4.2 Установка времени	16
4.3 Настройка функции Таймер	16
4.4 Выбор режима работы	17
4.5 Установка и визуализация заданного значения	18
4.6 Блокировка и разблокировка тактильного экрана	18
4.7 Настройки бесшумного режима	19
5. ТЕХНИЧЕСКОЕ ОБСЛУЖИВАНИЕ И КОНСЕРВАЦИЯ НА ЗИМУ²	
5.1 Техническое обслуживание	22
5.2 Консервация на зиму	22
6. ПРИЛОЖЕНИЯ	23
6.1 Электрические схемы	23
6.2 Включение подогрева в качестве приоритета для трехфазного насоса	24
6.3 Вид в разборе и съемные элементы	26
6.4 Справочник по устранению неисправностей	28
6.5 Гарантия	30
6.6 Окончание срока службы устройства	30

Внимательно прочитать и сохранить для дальнейших консультаций.

Этот документ необходимо передать владельцу плавательного бассейна, чтобы он его сохранил в надежном месте.

1. ОБЩИЕ ИНСТРУКЦИИ - БЕЗОПАСНОСТЬ

Благодарим Вас за приобретение данного теплового насоса для плавательного бассейна производства компании Hayward. Данное изделие разработано в соответствии со строгими производственными стандартами для удовлетворения предъявляемых требований по качеству. Данное изделие включает в себя всю информацию, необходимую для установки изделия, устранения неисправностей и его технического обслуживания. Перед тем как распаковать изделие или перед выполнением его технического обслуживания, внимательно ознакомьтесь с данным руководством.

Производитель данного изделия не несет никакой ответственности за причинение травм потребителю или повреждение изделия вследствие его неправильной установки, за устранение нарушений в работе или бесполезное техническое обслуживание. Крайне важно всегда следовать инструкциям, изложенным в данном руководстве.

После прочтения данного руководства держите его под рукой для дальнейшего использования.

Обученный персонал

- Установка, электрические подключения, обслуживание и ремонт устройства должны выполняться квалифицированным специалистом в соответствии с нормативными документами и отраслевыми стандартами, действующими в стране, в которой устройство будет устанавливаться (см. § 3.4). Любые работы с холодильным контуром должен выполнять специалист, имеющий сертификат, подтверждающий право работы с хладагентами. Для Франции:
 - Низковольтная электроустановка в соответствии с NF-C 15-100.
 - Законодательство по обращению с хладагентами: Указ 2007/737 и постановления о порядке его применения.

Условия установки

- Не пытайтесь выполнить установку этого устройства самостоятельно.
- Это изделие предназначено исключительно для бытового использования и установки вне помещений. Воздух, выходящий из изделия, должен проходить свободно и не должен использоваться для других целей, например для обогрева или охлаждения помещения или здания.
- Данный тепловой насос нагревает воду в плавательном бассейне, поддерживает постоянную температуру и не предназначен для использования в других целях.
- Проверьте шнур питания. Если шнур питания поврежден, его следует заменить у производителя, в службе послепродажного обслуживания или у любого лица, имеющего соответствующую квалификацию.

1. ОБЩИЕ ИНСТРУКЦИИ (продолжение)

- Устройство должно быть обязательно подключено к непрерывной цепи заземления. Длина заземляющего провода должна быть больше длины остальных проводов, чтобы предотвратить риск поражения электрическим током при отрывании шнура. Электроустановка должна быть оснащена дифференциальной защитой на 30 мА (см. § 3.4).
- Несоблюдение данных рекомендаций ведет к отмене гарантийных обязательств.

Инструкции по техническому обслуживанию

Для гарантирования продолжительной и надежной работы теплового насоса рекомендуется раз в год проводить следующие операции по обслуживанию устройства.

- Техническое обслуживание и необходимые процедуры должны осуществляться с частотой и в сроки, определенные в настоящем руководстве.
- Используйте только оригинальные запасные части.
- Проверьте шнур питания. Если шнур питания поврежден, его следует заменить у производителя, в службе послепродажного обслуживания или у любого лица, имеющего соответствующую квалификацию.
- Проверьте цепь заземления устройства и ее непрерывность.
- Очистите испаритель с помощью мягкой зубной щетки или воздушной/водяной струи (**Внимание: никогда не используйте для очистки высокое давление**).
- Проверьте, что конденсат хорошо стекает.
- Проверьте надежность гидротехнических и электрических соединений.
- Проверьте гидравлическую герметичность конденсатора.
- Проверку изоляции холодильной системы выполняет **уполномоченный специалист** с помощью детектора течи.



Перед производством любых работ по техническому обслуживанию теплового насоса необходимо отсоединить его от источника питания. Все операции по техническому обслуживанию должны производиться только специально подготовленным персоналом, имеющим опыт работы с жидкими хладагентами.

Инструкции по зимовке

- Переведите тепловой насос в режим "ВЫКЛ."
- Отключите тепловой насос от источника питания.
- Слейте содержимое конденсатора для предотвращения риска повреждения (риск возможного замерзания).
- Закройте "перепускной" вентиль и отсоедините штуцерные соединения входа/выхода.

1. ОБЩИЕ ИНСТРУКЦИИ (продолжение)

- С помощью пистолета высокого давления максимально выдуйте остатки воды из конденсатора.
- Перекройте вход и выход для воды теплового насоса для предотвращения попадания туда инородных тел.
- Укройте тепловой насос предназначенным для этих целей зимним чехлом.



Любые неполадки, вызванные неправильной консервацией на зимний период, аннулируют гарантию.

Условия установки

Детям от 8 лет, лицам с физическими и умственными расстройствами, а также с нарушениями чувствительности, или с отсутствием опыта и знаний, разрешается пользоваться устройством под присмотром, или если они получили инструкции по эксплуатации устройства и приняли к сведению сопутствующие риски. Не позволяйте детям играть с устройством.

Очистка и обслуживание устройства не должны выполняться детьми без присмотра.

Это изделие содержит газообразный хладагент R410A

Данное изделие содержит газ фреон, применение которого оговорено в Киотском протоколе. Не выпускайте эти газы в атмосферу.

Значение в рамках потенциала глобального потепления⁽¹⁾ : 2088. Значение базируется на 4-м отчете Межправительственной группы экспертов по изменению климата (GIEC).

Количество хладагента в соответствии с регламентом F-Gas 517/2014 указано на заводской табличке устройства.

Любые работы с контуром хладагента должен выполнять квалифицированный специалист, как указано выше.

В рамках европейского или местного законодательства могут проводиться периодические проверки на предмет возможной утечки хладагента. Для получения дополнительной информации обратитесь к Вашему местному дистрибьютору.

- Внимание! Хладагенты могут не иметь запаха.
- Не прокалывайте и не нагревайте трубопровод, так как существует опасность взрыва и получения сильных ожогов.
- Не используйте никакие средства для ускорения процесса размораживания или очистки, кроме тех, которые рекомендованы производителем.
- Устройство следует хранить в помещении, в котором нет постоянно работающих источников воспламенения (например, открытого огня, работающих газовых приборов или электронагревателей).

(1) Возможность глобального потепления

2. ТЕХНИЧЕСКИЕ ХАРАКТЕРИСТИКИ

2.1 Технические данные теплового насоса

Модели	ENERGYLINE PRO	ENP10TAS
Теплотворная производительность *	kW	36,9
Потребляемая электрическая мощность *	kW	6,87
Рабочий ток *	A	14,8
Напряжение питания	V / Ph / Hz	400 V / 3N~ / 50Hz
Предел срабатывания предохранителя, тип aM (предохранитель для защиты электродвигателей и кабелей)	A	20
Автоматический выключатель, кривая D	A	20
Количество компрессоров	/	1
Тип компрессора	/	Scroll
Количество вентиляторов	/	2
Мощность вентилятора	W	50 - 225
Скорость вращения вентиляторов	RPM	600 - 1050
Вентиляция	/	Horizontal
Уровень акустического давления (на 10 м) LpA	dB(A)	41
Гидротехническое подключение	mm	63
Номинальная пропускная способность*	m ³ /h	13
Снижения давления воды (макс)	kPa	13,8
Чистые размеры устройства (длина/ширина/высота)	mm	1482 / 485 / 1480
Вес нетто устройства	kg	182



* Характеристики согласно стандарт испытаний NF EN 14511, обновлению NF-414.
Сухой воздух 15°C - Относительная влажность 71% - Температура подаваемой воды 26°C.

2. ТЕХНИЧЕСКИЕ ХАРАКТЕРИСТИКИ

(продолжение)

2.2 Рабочий диапазон

Для обеспечения надежной и эффективной работы теплового насоса используйте его в следующих рабочих диапазонах температур и влажности.

	Режим подогрева 	Режим Охлаждение 
Температура окружающей среды	-12°C ~ +35°C	+7°C ~ +43°C
Температура воды	+12°C ~ +40°C	+8°C ~ +40°C
Относительная влажность	< 80%	< 80%
Рабочий диапазон заданного значения	+15°C ~ +32°C	+8°C ~ +32°C



Если температура или влажность не соответствуют указанным условиям, может сработать защитное устройство, и тогда тепловой насос может отключиться.



Максимальная температура нагрева ограничена до 32°C во избежание повреждения покрытия. Фирма Nauward не несет ответственности в случае эксплуатации при температуре выше 32°C.

2. ТЕХНИЧЕСКИЕ ХАРАКТЕРИСТИКИ (продолжение)

2.3 Размеры

Модель : EENP10TAS

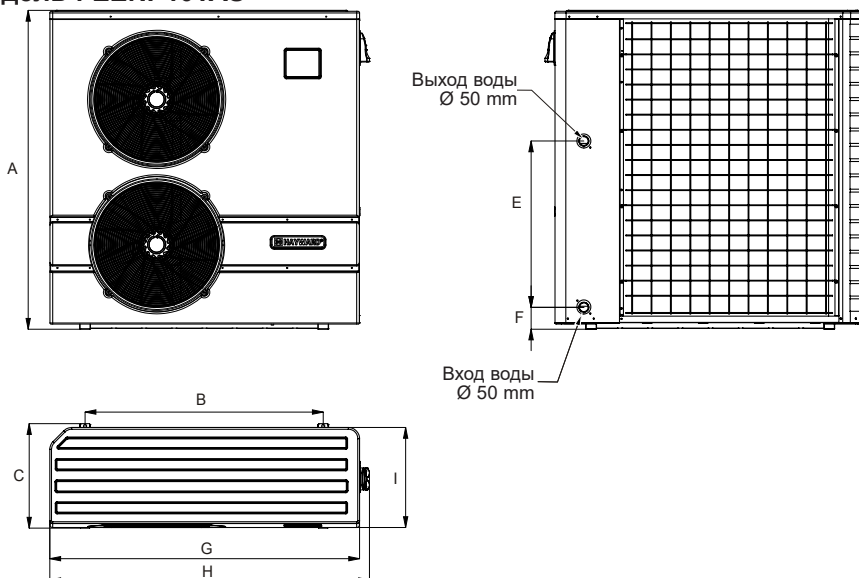

Устройство : mm

Позиция \ модель	ENP10TAS
A	1480
B	1105
C	485
D	/
E	771,5
F	101,5
G	1437
H	1483
I	464

3. УСТАНОВКА И ПОДКЛЮЧЕНИЕ

3.1 Принципиальная Схема

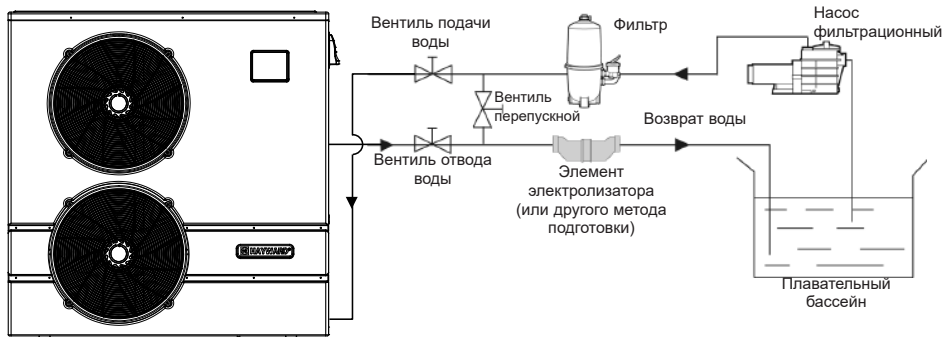

Примечание. Тепловой насос поставляется без какого-либо дополнительного оборудования для обработки или фильтрации воды. Представленные на схеме элементы поставляются фирмой, осуществляющей установку.

3.2 Тепловой насос



Разместите тепловой насос на открытом воздухе, отдельно от любого другого закрытого оборудования.

Выберите место предпочтительно с доступом солнечного света и защищенное от сильного ветра.

Устройство должно находиться в легко доступном месте для последующего монтажа и технического обслуживания.

Разместите его под навесом, с соблюдением всех указанных минимальных расстояний до других предметов, чтобы избежать всех рисков, связанных с рециркуляцией воздуха и возможного отрицательного влияния теплового насоса на состояние окружающей среды.

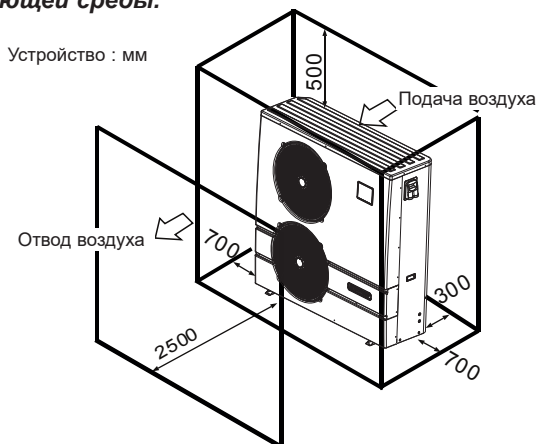

3. УСТАНОВКА И ПОДКЛЮЧЕНИЕ (продолжение)



Не устанавливайте устройство непосредственно на пол, так как это может привести к проблемам.

Для установки устройства на пол предпочтительно использовать антивибрационные подкладки.

Не следует использовать настенный кронштейн в условиях, где могут передаваться вибрации.

Не устанавливайте тепловой насос на подставку, которая может усилить вибрацию устройства.

Не устанавливайте тепловой насос в месте, которое может повышать уровень шума, или где шум от устройства может помешать соседям.

Не используйте адгезивы, так как они не могут обеспечить надежное крепление.

Предпочтительно устанавливать тепловой насос на плоской, не связанной бетонной плите. Установите тепловой насос на прилагаемые сайлент-блоки (прилагаются винты и шайбы). Во избежание несчастного случая или повреждения оборудования и травмирования людей закрепите устройство, используя указанный момент затяжки.

Как вариант, тепловой насос можно установить на резиновые крепления к полу с помощью подходящих винтов (не входят в комплект поставки).

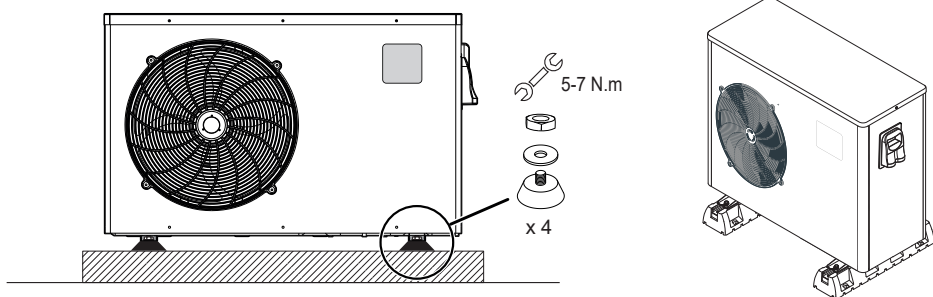

Максимальное расстояние между тепловым насосом и плавательным бассейном не должно превышать 15 м.

Общая длина шлангов подачи и отвода воды не должна превышать 30 м.

Изолировать шланги от поверхности земли и не закапывать.

Тепловой насос должен быть установлен на минимальном расстоянии от бассейна в соответствии с NF C 15-100 (либо в 3,5 м от водной поверхности во Франции) или в соответствии со стандартами установки в других странах.

Не устанавливать тепловой насос вблизи источников тепла.

При установке в снежных регионах, рекомендуется устанавливать изделие в помещении, чтобы избежать накопления снега на испарителе.

3. УСТАНОВКА И ПОДКЛЮЧЕНИЕ (продолжение)

3.3 Гидротехническое подключение

Тепловой насос поставляется с двумя штуцерными соединениями диаметром 50 мм с накидной гайкой. Для подвода воды используйте ПВХ шланги Ø 50 мм. Соедините входное отверстие для воды теплового насоса со шлангом, ведущим к фильтрационному блоку, затем соедините выходное отверстие для воды теплового насоса со шлангом, подающим воду в бассейн (см. приведенную ниже схему).

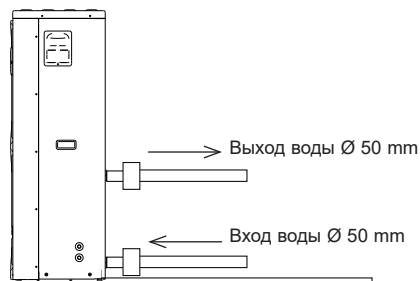

Установите так называемый "перепускной" вентиль между входным и выходным отверстиями теплового насоса.



Если используются автоматическое питательное устройство или электризатор, они должны быть установлены непосредственно после теплового насоса с целью предохранения конденсатора Titane от чрезмерного накопления в нем химических продуктов.



Постарайтесь установить перепускной вентиль и поставляемые штуцерные соединения на одном уровне с входом и выходом воды на устройстве, чтобы упростить спуск воды на зимний период, облегчив таким образом доступ к элементам и монтаж на период технического обслуживания.

3. УСТАНОВКА И ПОДКЛЮЧЕНИЕ (продолжение)

3.4 Электрическое Подключение



Электроподключение и все соединения данного оборудования должны соответствовать местным действующим правилам установки.

Франция	NF C15-100	Великобритания	BS7671:1992
Дания	DIN VDE 0100-702	Англия и Уэльс	EVHS-HD 384-7-702
А	ÖVE 8001-4-702	Венгрия	MSZ 2364-702/1994/MSZ 10-553 1/1990
Испания	UNE 20460-7-702 1993, RECBT ITC-BT-31 2002	Мэн	MSA HD 384-7-702.S2
Ирландия	Монтажные правила + IS HD 384-7-702	Польша	PN-IEC 60364-7-702:1999
Италия	CEI 64-8/7	Чехия	CSN 33 2000 7-702
Люксембург	384-7.702 S2	Словакия	STN 33 2000-7-702
Нидерланды	NEN 1010-7-702	Словения	SIST HD 384-7-702.S2
Португалия	RSIUEE	Турция	TS IEC 60364-7-702



Убедитесь, что имеющееся в наличии электропитание и частота соответствуют требуемым параметрам тока, приняв во внимание специфическую установку прибора и потребности всех других устройств, подключенных к данной цепи.

ENP10TAS 400 V \sim +/- 10 % 50 Hz 3 фаз

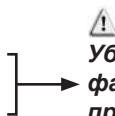

Убедитесь в том, что фазовое равновесие не превышает 2%

Соблюдайте требования соответствующей схемы соединений в приложении.

Соединительная коробка находится с правой стороны устройства. Три контактных соединения предназначены для подключения электропитания, два других - для подключения механизма управления фильтрационного насоса (Системы автоматического управления).

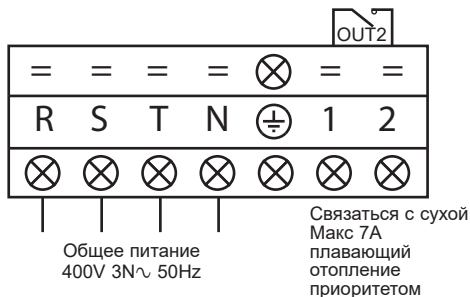

3. УСТАНОВКА И ПОДКЛЮЧЕНИЕ (продолжение)



Запрещено использовать розетку для подачи питания. Линия электропитания должна быть оснащена соответствующим многополюсным устройством защиты типа изогнутого предохранителя D, а также автоматическим выключателем дифференциальной защиты на 30 мА. (см. следующую таблицу).

модель		ENP10TAS
Электропитание	V/Ph/Hz	400V 3N~ 50Hz
Предел срабатывания предохранителя (*)	A	20 aM
Автоматический выключатель, кривая D	A	20 D
Сечение кабеля	mm ²	5G4 5 x 4
(*) тип aM, предохранитель для защиты электродвигателей и кабелей		



Используйте кабель питания типа RO2V/R2V или аналогичный.



Сечения кабеля даны из расчета максимальной длины - 25 м. Тем не менее, необходимо их проверять и адаптировать согласно условиям установки.



Перед открытием блока электроуправления всегда отключайте источник основного питания.

3.5 Первый запуск

Процедура запуска - после того, как закончена установка, неуклонно следуйте следующему порядку действий :

- 1) Проверните вентиляторы рукой для проверки их свободного вращения и соответствия крепления винта на валу мотора.
- 2) Убедитесь в том, что устройство правильно подключено к источнику основного питания (см. схему соединения в приложении).
- 3) Включите фильтрационный насос.
- 4) Перед тем как перейти к режимам подогрева или охлаждения, проверьте, чтобы все вентили были открыты и чтобы вода поступала в устройство.
- 5) Проверьте, чтобы трубка оттока конденсата была правильно установлена, чтобы не создавалось никаких помех.
- 6) Включите электропитание устройства, затем нажмите кнопку Пуск/Стоп  на панели управления.

3. УСТАНОВКА И ПОДКЛЮЧЕНИЕ (продолжение)

- 7) Убедитесь в том, что в то время, как устройство находится в режиме ВКЛ, не горит ни один код ТРЕВОГИ (см. справочник по устранению неисправностей).
- 8) Установите пропускную способность для воды с помощью перепускного вентиля (см. § 3.6 и 2.1) на уровне, предусмотренном для соответствующей модели, так, чтобы разница температур воды на входе/выходе составляла 2°C.
- 9) После нескольких минут работы проверьте, чтобы температура воздуха, выходящего из устройства, понизилась (была между 5 и 10°).
- 10) Не выключая устройства, остановите фильтрационный насос. Устройство должно автоматически отключиться и показать код ошибки E03.
- 11) Оставьте устройство и насос плавательного бассейна включенными круглосуточно, пока температура воды не достигнет желаемого уровня. Когда температура воды на входе достигнет заданного значения, устройство отключится. Оно снова самостоятельно включится (при условии, что будет включен насос плавательного бассейна), если температура в плавательном бассейне понизится хотя бы на 0.5°C от заданной.

Контроллер пропускной способности - Устройство снабжено контроллером пропускной способности, который включает тепловой насос при включенном фильтрационном насосе плавательного бассейна, и отключает тепловой насос при неработающем фильтрационном насосе. При отсутствии поступления воды на экране регулятора загорится код ошибки E03 (См. § 6.4).

Задержка - устройство работает с задержкой в 3 минуты с целью защиты компонентов управляющей цепи, устранения любой нестабильности при повторном запуске и всех помех в цепи контактора. Благодаря данной задержке устройство автоматически включается примерно через 3 минуты после полного отключения управляющей цепи. Таким же образом кратковременное отключение тока активизирует цепь задержки включения.

Фазовый контроллер - Трехфазные блоки включают в себя фазовый контроллер для обеспечения правильного направления вращения компрессора. Если устройство не запускается, проверьте состояние фазового контроллера, расположенного в электрошкафе.

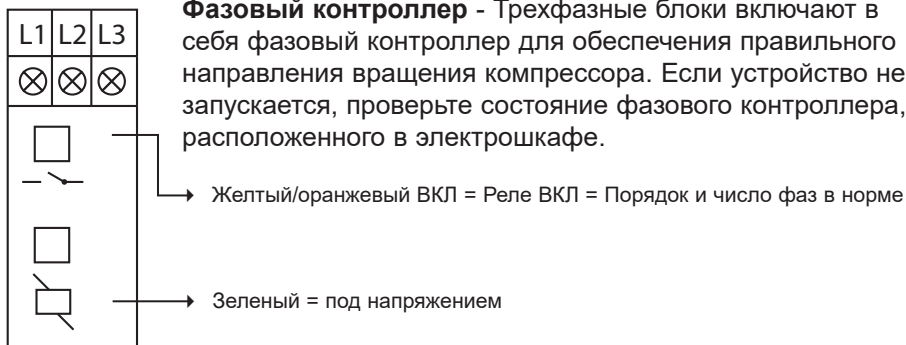

3. УСТАНОВКА И ПОДКЛЮЧЕНИЕ (продолжение)

3.6 Установка пропускной способности насоса

Открыв вентили входа и выхода воды, отрегулируйте так называемый "перепускной" вентиль так, чтобы разница между температурами воды на входе и выходе составляла 2°C (см. § 3.1 принципиальной схемы). Вы можете проверить правильность регулировки, контролируя отображаемые на командной панели значения температур воды на входе и выходе.

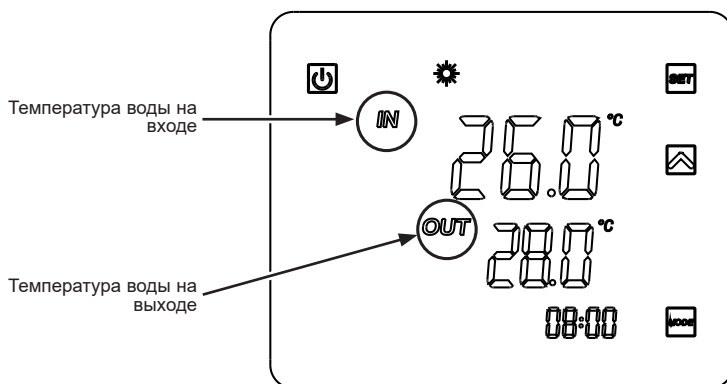

Примечание : Открытие так называемого "перепускного" вентиля понижает влияние пропускной способности на повышение разницы температур ΔT .
Закрытие так называемого "перепускного" вентиля повышает влияние пропускной способности на понижение разницы температур ΔT .

4. ИНТЕРФЕЙС ПОЛЬЗОВАТЕЛЯ

4.1 Общие сведения

Тепловой насос оборудован панелью цифрового управления с тактильным экраном, соединенной электрически с устройством и настроенным на заводе на режим подогрева.

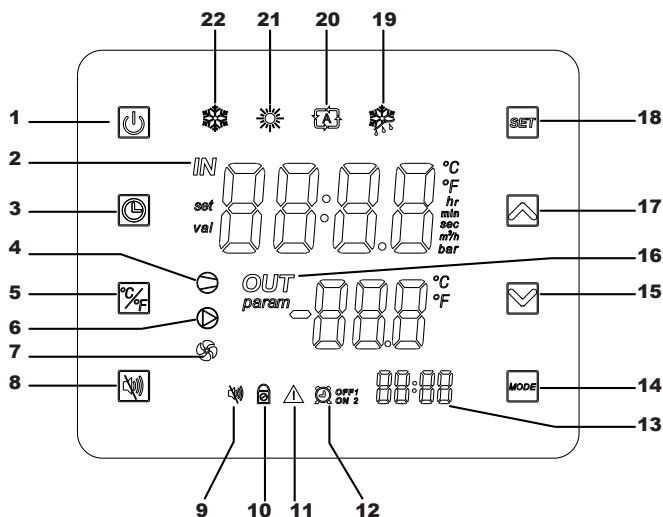

Условные обозначения

1		Пуск/Стоп
2	<i>IN</i>	Воды на входе
3		Установка времени и Таймера
4		Компрессор ON
5		Конвертация °C/°F
6		Сухой контакт OUT2
7		Вентилятор ON
8		Указатель режима тишины
9		Контрольный указатель режима тишины
10		Экран заблокирован
11		Тревога

12		Таймеры 1 и 2
13		Время таймеров
14		Выбор режима
15		Перемещение вниз/ Уменьшение
16	<i>OUT</i>	Воды на выходе
17		Перемещение вверх/ Увеличение
18		Сохранение/Настройки
19		Режим оттаивания
20		Режим Автоматический
21		Режим Подогрева
22		Режим Охлаждения

4. ИНТЕРФЕЙС ПОЛЬЗОВАТЕЛЯ (продолжение)

Режим ВЫКЛ.

Когда тепловой насос находится в спящем режиме (Режим ВЫКЛ), на экране регулятора видна надпись "ВЫКЛ".

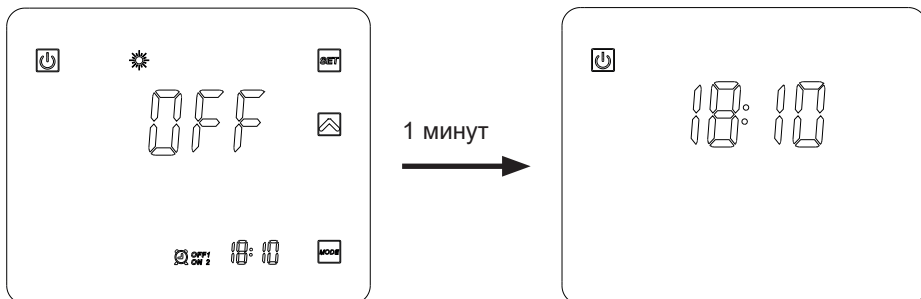

Режим ВКЛ.

Когда тепловой насос находится в рабочем или регулировочном режиме (Режим ВКЛ), на экране регулятора отражаются температура воды на входе и выходе.

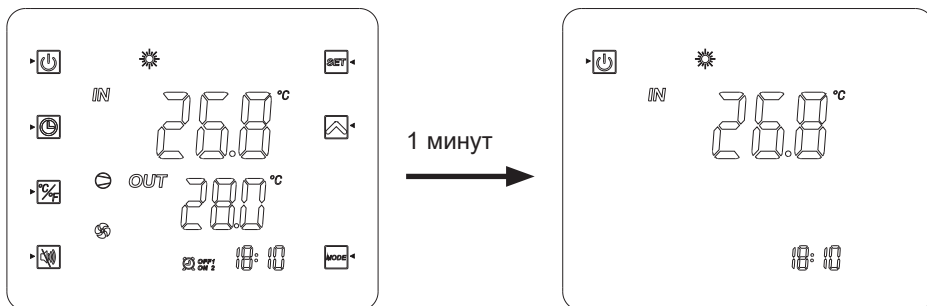









4. ИНТЕРФЕЙС ПОЛЬЗОВАТЕЛЯ (продолжение)

В конце настройки нажмите  для подтверждения.
Параметры записи автоматически после 20-х годов без действия.

4.2 Установка времени

Если экран находится в спящем режиме, коротко нажмите на кнопку .









- 1) Нажмите  для отображения символа .
- 2) Нажмите , отображаемое время станет мигать. Настройте часы при помощи кнопок  .
- 3) Нажмите  затем установите минуты при помощи кнопок  .
- 4) Подтвердите нажатием на .

4.3 Настройка функции Таймер











Установка этой функции нужна в том случае, если Вы хотите, чтобы тепловой насос работал в течение более короткого периода времени по сравнению с установленным временем фильтрации. Вы также можете запрограммировать произвольное время включения и выключения или просто отключить временной рабочий диапазон (например, ночью).



Существует возможность программирования двух Таймеров Запуска (ON1 и ON2) и двух Таймеров Остановки (OFF1 и OFF2).

Программирование Таймера 1 – Départ

- 1) Поддержка в течение  2с, Таймер ON1  ¹ начнет мигать (*).
- 2) Нажмите  для настройки часов при помощи кнопок  .
- 3) Нажмите  для настройки минут при помощи кнопок  .
- 4) Подтвердите нажатием на .

Программирование Таймера 1 – Остановка

- 1) Поддержка в течение  2с, Таймер ON1  ¹ начнет мигать (*).
Однократно нажмите на , Таймер OFF1  начнет мигать.
- 2) Нажмите  для настройки часов при помощи кнопок  .
- 3) Нажмите  для настройки минут при помощи кнопок  .
- 4) Подтвердите нажатием на .

(*) Для прямого перехода к Таймеру ON2  удерживайте 
в течение 2с, затем дважды нажмите на .

4. ИНТЕРФЕЙС ПОЛЬЗОВАТЕЛЯ (продолжение)

Программирование Таймера 2

После настройки Таймера 1 осуществляется прямой переход к Таймеру 2:

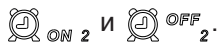

Выполняйте те же действия, что и для Таймера 1.

нота: Для прямого перехода к Таймеру ON2 удерживайте в течение 2с, затем дважды нажмите на .

Удаление Таймеров (Запуск и Остановка)

- 1) Поддержка в течение 2с, Таймер ON1 начнет мигать. (*)
 - 2) Нажмите , отображаемое время станет мигать.
 - 3) Нажмите для удаления Таймера .
 - 4) Нажмите для подтверждения.
 - 5) Поддержка в течение 2с, Таймер ON1 начнет мигать. Однократно нажмите на , Таймер начнет мигать. (*)
 - 6) Нажмите , отображаемое время станет мигать.
 - 7) Нажмите для удаления Таймера .
- (*) Для доступа к Таймерам 2 или , выполните этапы 1) или 4), затем дважды нажмите на . Выполните вышеуказанные действия.

4.4 Выбор режима работы

В Режиме “ВЫКЛ.” или “ВКЛ.”

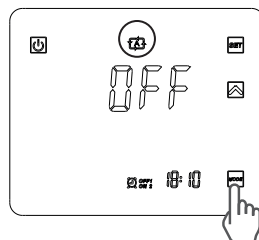
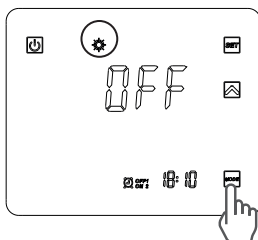
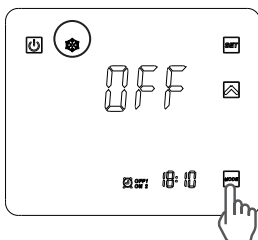

Нажмите кнопку для переключения режимов: охлаждение, нагрев или автоматический.



Если тепловой насос установлен в отопления или охлаждения в режим только, смена режима не возможно.

4. ИНТЕРФЕЙС ПОЛЬЗОВАТЕЛЯ (продолжение)



4.5 Установка и визуализация заданного значения (Желаемая температура воды)

Если кнопку  не видно на экране, коротко нажмите на .

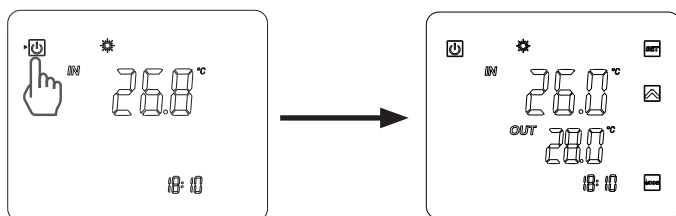
(Во время работы или при остановке достаточно нажать кнопку  для отображения заданного значения.)





В Режиме "ВЫКЛ." и Режиме "ВКЛ."



Нажмите кнопку  для отображения заданного значения, затем нажмите на  или  для определения необходимого заданного значения. Установка возможна с шагом 0,5 °С.



Чтобы избежать деформации жаровых трубок, рекомендуется никогда не превышать температуру 30°C.

4.6 Блокировка и разблокировка тактильного экрана

Нажать на кнопку Пуск/Стоп  на 5 сек., пока не раздастся звуковой сигнал и не появится символ .

Для разблокировки нажать  на 5 сек., пока не раздастся звуковой сигнал и не исчезнет символ .

4. ИНТЕРФЕЙС ПОЛЬЗОВАТЕЛЯ (продолжение)

4.7 Настройки бесшумного режима

Эта функция позволяет использовать тепловой насос со скоростью вращения лопастей вентилятора, сниженной до 600 об./мин. в течение максимум 8 часов, чтобы уменьшить уровень шума в ночное и/или дневное время согласно местонахождению теплового насоса по отношению к окрестным жилым домам и/или водоемам.



Эта функция может быть активирована/деактивирована вручную или с помощью таймера.

Активация режима вручную

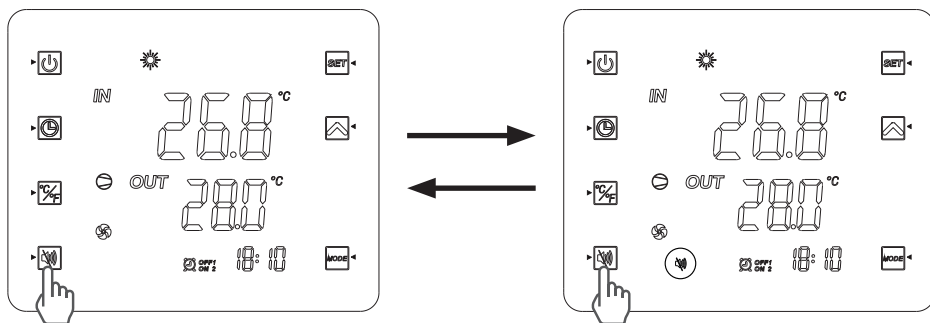
- 1) Нажмите на кнопку .
- 2) Нижеуказанное отображение появится на экране, режим Тишина активирован на 8 ближайших часов.
- 3) Скорость вращения вентиляторов постепенно будет снижаться до и сохранится в течение не более 8 часов.
- 4) Через 8 часов работы функция будет автоматически отключена, и скорость вращения вентиляторов восстановится в зависимости от внешней температуры воздуха.



Ручная деактивация

- 1) Нажмите на кнопку .
- 2) Контрольный указатель  пропадет с экрана: режим Тишина отключен.
- 3) Вентиляторы устанавливают скорость вращения в зависимости от внешней температуры воздуха

4. ИНТЕРФЕЙС ПОЛЬЗОВАТЕЛЯ (продолжение)



Настройка беззвучного режима

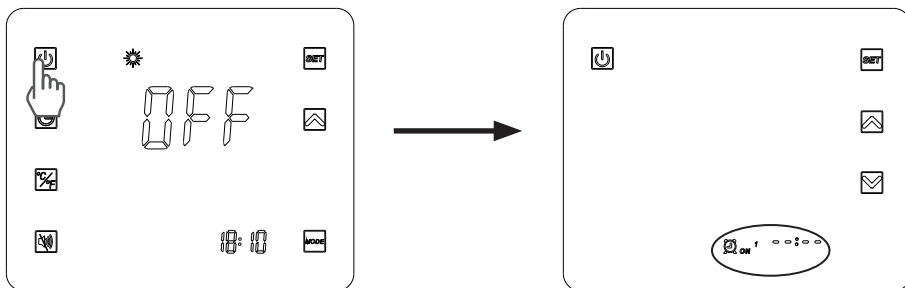

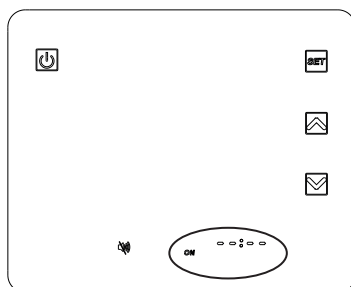

1) Поддержка в течение  2с, Таймер ON1  ON¹ начнет мигать.



2) Нажмите 4 раза на  до появления нижеуказанного экрана.









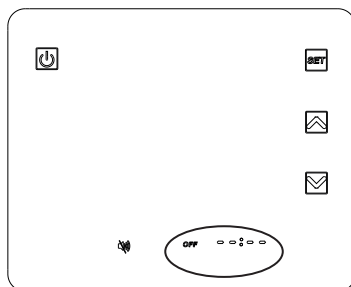

3) Нажмите , отображаемые часы станут мигать. Используйте стрелки   для настройки часов запуска.

4) Нажмите , отображаемые минуты станут мигать. Используйте стрелки   для настройки минут запуска. Подтвердите нажатием на .

5) Нажмите  для настройки времени окончания: индикация OFF начнет мигать.



4. ИНТЕРФЕЙС ПОЛЬЗОВАТЕЛЯ (продолжение)

- 6) Нажмите , отображаемые часы станут мигать. Используйте стрелки   для настройки часа окончания.
- 7) Нажмите , отображаемые минуты станут мигать. Используйте стрелки   для настройки минут окончания. Подтвердите нажатием на .
- 8) Нажмите  для возврата на предыдущий экран.
Индикаторы ON-OFF отображаются так, как указано ниже.

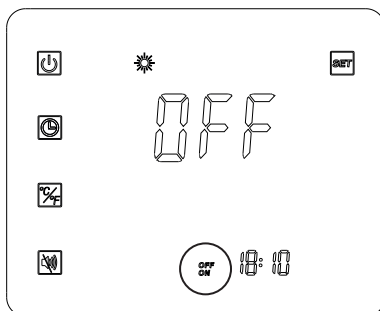

нота: Шаг интервала для настройки минут равен 10.

После завершения настройки бесшумного режима он остается активированным по умолчанию 7 дней в неделю.

5. ТЕХНИЧЕСКОЕ ОБСЛУЖИВАНИЕ И КОНСЕРВАЦИЯ НА ЗИМУ

5.1 Техническое обслуживание

Для гарантирования продолжительной и надежной работы теплового насоса рекомендуется 1 раз в год проводить следующие операции по обслуживанию устройства.

- Очистите испаритель с помощью мягкой щетки или воздушной/водяной струи (**Внимание! Никогда не используйте для очистки высокое давление**).
- Проверьте, что конденсат хорошо стекает.
- Проверьте надежность гидротехнических и электрических соединений
- Проверьте гидравлическую герметичность конденсатора.



Перед производством любых работ по техническому обслуживанию теплового насоса необходимо отсоединить его от источника питания. Все операции по техническому обслуживанию должны производиться только специально подготовленным персоналом, имеющим опыт работы с жидкими хладагентами.

5.2 Консервация на зиму

- Переведите тепловой насос в режим «ВЫКЛ»
- Отключите тепловой насос от источника питания.
- Слейте содержимое конденсатора для предотвращения риска повреждения. (Риск возможного замерзания).
- Закройте «перепускной» клапан и отсоедините штуцерные соединения входа/выхода.
- С помощью пистолета высокого давления максимально выдуйте остатки воды из охладителя.
- Перекройте вход и выход для воды теплового насоса для предотвращения попадания туда инородных тел.
- Укройте тепловой насос предназначенным для этих целей зимним чехлом.



Любые неполадки, вызванные неправильной консервацией на зимний период, аннулируют гарантию.

6. ПРИЛОЖЕНИЯ

6.1 Электрические схемы

ENP10TAS

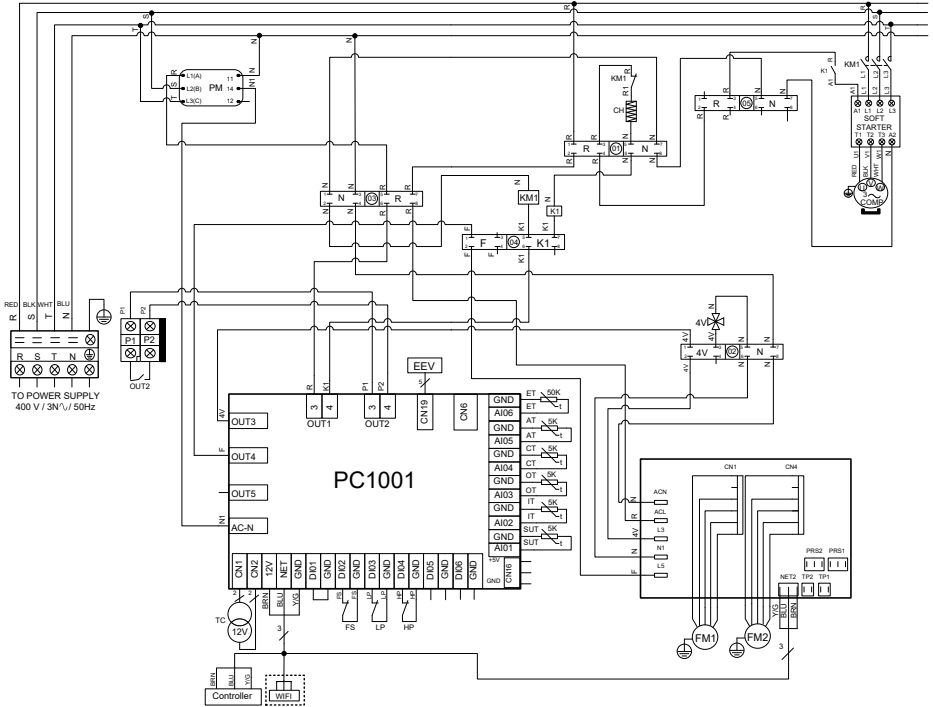

ПРИМЕЧАНИЯ :

- AT : ДАТЧИК ТЕМПЕРАТУРЫ ВОЗДУХА
- COMP : КОМПРЕССОР
- CT : ДАТЧИК ТЕМПЕРАТУРЫ ИСПАРИТЕЛЯ
- EEV : ЭЛЕКТРОННЫЙ РЕДУКТОР
- FM1-2 : МОТОР ВЕНТИЛЯТОРА
- FS : ДЕТЕКТОР НАЛИЧИЯ ВОДЫ
- HP : ПРЕССОСТАТ ВЫСОКОГО ДАВЛЕНИЯ
- IT : ДАТЧИК ТЕМПЕРАТУРЫ ВОДЫ НА ВХОДЕ
- LP : ПРЕССОСТАТ НИЗКОГО ДАВЛЕНИЯ

- OT : ДАТЧИК ТЕМПЕРАТУРЫ ВОДЫ НА ВЫХОДЕ
- SUT : ДАТЧИК ТЕМПЕРАТУРЫ ВСАСЫВАНИЯ
- TC : ТРАНСФОРМАТОР 230 В~ / 12 В~
- 4V : 4-Х КАНАЛЬНЫЙ ВЕНТИЛЬ
- KM1 : КОНТАКТОР МОЩНОСТИ КОМПРЕССОРА
- PM : ФАЗОВЫЙ КОНТРОЛЛЕР
- CN1 : СОПРОТИВЛЕНИЕ КОЖУХА
- ET : ДАТЧИК ТЕМПЕРАТУРЫ НАГРЕТАНИЯ
- OUT2 : ВОБОДНЫЙ КОНТАКТ С МАКСИМАЛЬНЫМ ПОТЕНЦИАЛОМ 7А
- : ДОПОЛНИТЕЛЬНО

6. ПРИЛОЖЕНИЯ (продолжение)

6.2 Включение подогрева в качестве приоритета для трехфазного насоса

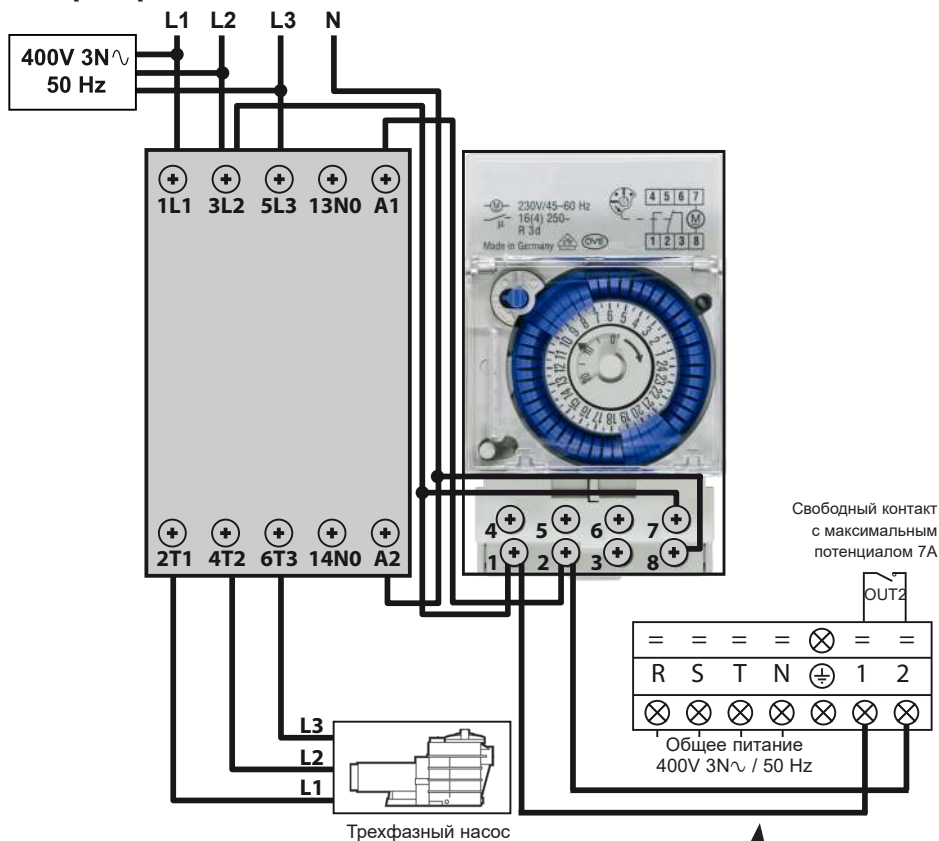

Разъемы 1 и 2 обеспечивают подачу питания на бесполярный контакт при напряжении 230V~ / 50Hz. Подключите кабели к разъемам 1 и 2 в соответствии с указанной монтажной схемой для автоматической регулировки насоса фильтрации по циклам в 2 минуты каждый час, когда температура резервуара снижается ниже установленного значения.

 **Никогда не подключать питание фильтрационного насоса прямо к клеммам 1 и 2.**



Намеренно оставлено пустым

6. ПРИЛОЖЕНИЯ (продолжение)

6.3 Вид в разборе и съемные элементы

ENP10TAS

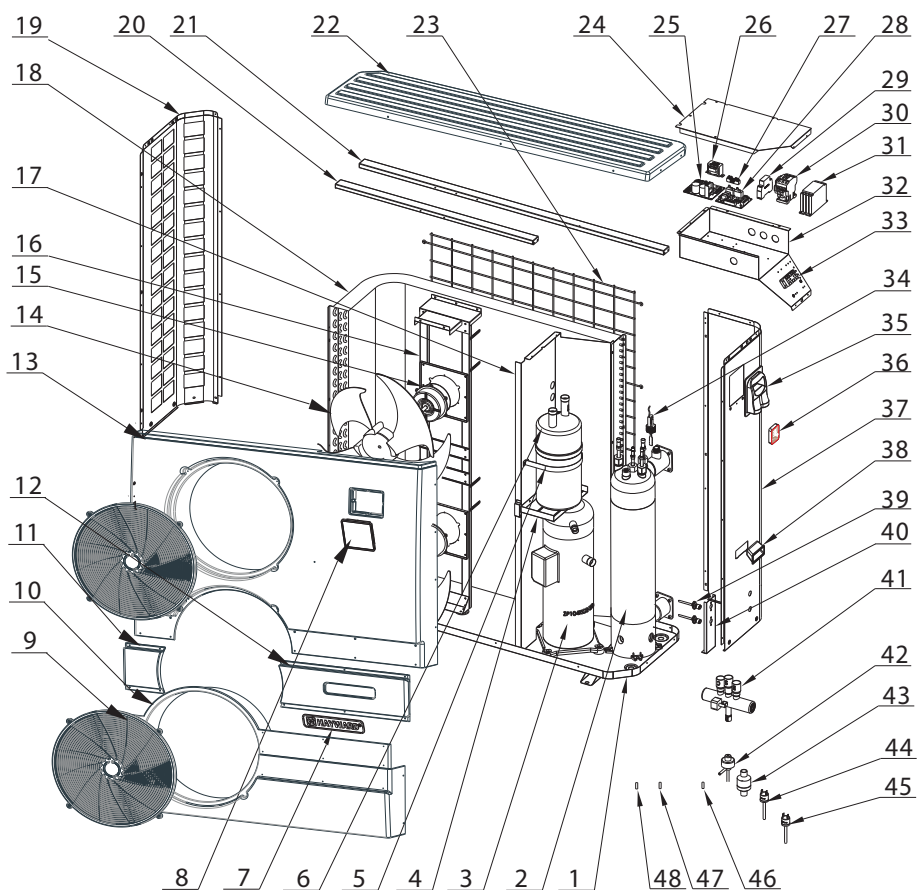

6. ПРИЛОЖЕНИЯ (продолжение)

ENP10TAS

Индикация	Справочный номер	Название	Индикация	Справочный номер	Название
1	HWX32005210049	Дно	27	HWX20003909	Переходник, 2-х контактный
2	HWX32005120009	Конденсатор Titane/ ПВХ	28	HWX950531014516	Электронная карта
3	HWX20000110153	Компрессор	29	HWX200036023	Контроллер Фаза
4	HWX32027210011	Плита резервуара для жидкости	30	HWX20000360209	Контактор компрессора трехфазный
5	HWX32027210013	Зажимный хомут	31	HWX20000360092	Электронный пусковой механизм
6	HWX35141402	Пластового флюида	32	HWX32005210054	Распределительная коробка
7	HWX20000230596	Логотип Hayward	33	HWX20000390180	Контакт 5 соед. Разд.
8	HWX95005010018	светодиодный контроллер	34	HWX200036005	Детектор пропускной способности
9	HWX32020220001	Защитная сетка вентилятора	35	HWX32009220032	Трапп автоматизированные
10	HWX32005220002	Нижняя передняя панель	36	HWX95005010014	Модуль WiFi
11	HWX32005220005	Левая декоративная панель	37	HWX32005210060	Правая панель
12	HWX32005220004	Правая декоративная панель	38	HWX32008220037	Ручка
13	HWX32005220001	Верхняя передняя панель	39	HWX20000140353	Отбор давления высокого & низкого
14	HWX20000270025	Винт вентилятора	40	HWX32019210038	Опорная плита вводов высокого/ низкого давления
15	HWX20000330361	Двигатель постоянного тока	41	HWX20011488	4-ходовой клапан
16	HWX32005210058	Опора двигателя	42	HWX20000140338	Электронный редуктор
17	HWX32005210065	Перегородка	43	HWX20041455	Фильтр
18	HWX32005120008	Испаритель	44	HWX20003603	Реле низкого давления
19	HWX32005210051	Левая панель	45	HWX20013605	Реле высокого давления
20	HWX32005220055	Короткий элемент жесткости	46/47	HWX20003242	Датчик температуры испарителя/воздух/ вода
21	HWX32005210056	Широкий жесткости	48	HWX20003223	Датчик Компрессор 50 кΩ
22	HWX32005220003	Верхняя панель	*49*	HWX20000240208	Защита от атмосферных осадков
23	HWX32005210063	Защита испарителя	*50*	HWX200026009	Уплотнительное кольцо ID 48-Ер 5 мм
24	HWX32005210053	Электрическая панель защиты	*51*	HWX200026061	Уплотнительное кольцо ID 43-Ер 3,4 мм
25	HWX950531024107	Двигатель постоянного тока	*52*	HWX20003214	Соппротивление кожуха
26	HWX200037003	Трансформатор 230V~ 12V~	*53*	HWX20002625	Амортизирующий блок

Примечание: Метки *xx* не обозначены на соответствующем покомпонентном изображении.

6. ПРИЛОЖЕНИЯ (продолжение)



6.4 Справочник по устранению неисправностей

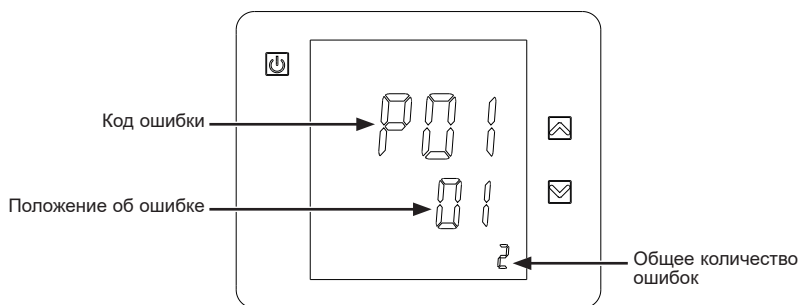

Некоторые операции должны выполняться квалифицированными специалистами.

В случае неисправности следующие индикаторы появятся на экране:



В случае повторяющейся ошибки, нажмите  или  прокрутите коды ошибок. См. таблицу ниже.

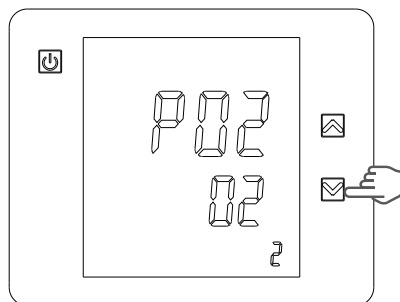

6. ПРИЛОЖЕНИЯ (продолжение)

Неисправности	Коды ошибок	Описание	Устранение
Неисправность датчика воды на входе	P01	Датчик открыт или произошло короткое замыкание.	Проверить или заменить датчик.
Неисправность датчика воды на выходе	P02	Датчик открыт или произошло короткое замыкание.	Проверить или заменить датчик.
Неисправность датчика оттаивания	P05	Датчик открыт или произошло короткое замыкание.	Проверить или заменить датчик.
Неисправность датчика температуры окружающей среды	P04	Датчик открыт или произошло короткое замыкание.	Проверить или заменить датчик.
Отсутствие зонда всасывания компрессора	P07	Датчик открыт или произошло короткое замыкание.	Проверить или заменить датчик.
Слишком большая разница температур воды на выходе и на входе	E06	Недостаточная пропускная способность, разница давления воды незначительна / чрезмерна.	Проверить пропускную способность или наличие закупоривания системы.
Защита от замерзания Холодный режим	E07	Количество воды на выходе слишком мало.	Проверить пропускную способность или датчик температуры воды на выходе.
Защита от замерзания - уровень 1	E19	Температура окружающей среды или воды на входе слишком низкая.	
Защита от замерзания - уровень 2	E29	Температура окружающей среды или воды на входе еще ниже.	
Защита от высокого давления	E01	Давление в холодильной системе слишком высокое, или пропускная способность слишком низкая, или засорен испаритель, или приток воздуха слишком слабый.	Проверить прессиостат высокого давления и давление в холодильной системе. Проверить пропускную способность в отношении воды и воздуха. Проверить исправность контроллера пропускной способности. Проверить, открыты ли вентили на входе и выходе воды. Проверить регулировку перепускной системы.
Защита от низкого давления	E02	Давление в холодильной системе слишком низкое, или слабый приток воздуха, или закупорен испаритель.	Проверьте прессиостат низкого давления и давление в холодильной системе, чтобы убедиться в наличии возможной утечки. Очистить поверхность испарителя. Проверить скорость вращения вентилятора. Проверить наличие свободного доступа воздуха к испарителю.
Неисправность детектора пропускной способности	E03	Недостаточная пропускная способность в отношении воды, или короткое замыкание детектора, или детектор неисправен	Проверьте пропускную способность в отношении воды, фильтрационный насос и детектор пропускной способности на предмет возможных неисправностей.
Сбои в передаче информации	E08	Неисправность светодиодного контроллера или плохое подключение блока управления процессором.	Проверьте соединения кабелей NET и NET 1.
Компрессор не запускается	E09	не хватает фазы или неверный порядок фаз	проверить наличие 3 фаз изменить порядок фаз на уровне контакта электрического подключения теплового насоса

6. ПРИЛОЖЕНИЯ (продолжение)

6.5 Гарантия

ГАРАНТИЙНЫЕ ОБЯЗАТЕЛЬСТВА

На всю продукцию компании HAYWARD в течение двух лет с момента приобретения распространяется гарантия отсутствия дефектов, связанных с работой или материалами. Настоящая гарантия действительна лишь при предъявлении документа, подтверждающего факт и дату покупки. В связи с этим мы рекомендуем сохранять товарный чек.

Гарантия компании HAYWARD сводится лишь к ремонту или замене, по выбору компании HAYWARD, дефектного изделия при условии его нормальной эксплуатации в соответствии с требованиями инструкции по эксплуатации, отсутствия каких-либо модификаций изделия и использования компонентов и запасных частей исключительно компании HAYWARD. Действие гарантии не распространяется на последствия воздействия мороза и химических веществ. Все прочие расходы (доставка, производство работ, ...) не включены в гарантию. Компания HAYWARD не несет ответственности за любой ущерб, прямой или косвенный, являющийся следствием неправильной установки, подключения или работы изделия.

Для того чтобы воспользоваться гарантией и потребовать возмещения стоимости или замены изделия, обратитесь к Вашему продавцу. Возврат изделия на завод-изготовитель невозможен без нашего предварительного письменного согласия.

Гарантия не распространяется на быстроизнашивающиеся детали.

6.6 Окончание срока службы устройства



Символ перечеркнутой корзины, обозначающий переработку и утилизацию электрических и электронных отходов, означает, что изделия, отмеченные таким символом, нельзя выбрасывать вместе с бытовым мусором, крупногабаритными предметами или на свалку.

По окончании срока службы устройство необходимо отдать отдельно для утилизации или переработки. В странах Европейского Союза и в Норвегии создана специальная процедура утилизации такого вида изделий. Для сбора, демонтажа и утилизации этого устройства необходимо обратиться к установщику или местному представителю.

Утилизация хладагента, масла и других деталей элементов должна выполняться квалифицированным специалистом в соответствии с региональным и национальным законодательством.

Если изделие содержит аккумуляторные батарейки, отмеченные этим символом, это означает, что аккумуляторы могут содержать вредные или загрязняющие вещества. В этом случае утилизировать аккумуляторы необходимо в пункте сбора использованных аккумуляторных батареек.

Намеренно оставлено пустым

Hayward® is registered trademark
of Hayward® Holdings, Inc.
© 2023 Hayward® Holdings, Inc.

